

**40V, 236A, 1.3mΩ N-channel Power SGT MOSFET**
**JMSL04018G3LQ**
**Features**

- Ultra-low ON-resistance,  $R_{DS(ON)}$
- Low Gate Charge
- 100% UIS Tested
- 100%  $\Delta V_{ds}$  Tested
- Halogen-free; RoHS-compliant
- AEC-Q101 Qualified

**Applications**

- Load Switch
- PWM Application
- General Automotive Application

**Product Summary**

Parameters	Value	Unit
$V_{DSS}$	40	V
$V_{GS(th\_Typ)}$	1.8	V
$I_D(@V_{GS}=10V)$	236	A
$R_{DS(ON)\_Typ}(@V_{GS}=10V)$	1.3	mΩ
$R_{DS(ON)\_Typ}(@V_{GS}=4.5V)$	1.8	mΩ

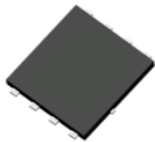

Top View

**PDFN5X6-8L**

Bottom View

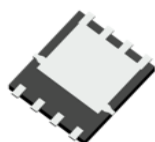
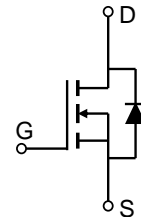
**Pin Assignment**

**Schematic Diagram**
**Ordering Information**

Device	Marking	MSL	Form	Package	Reel(pcs)	Per Carton (pcs)
JMSL04018G3LQ-13	SL040183LQ	1	Tape&Reel	PDFN5x6-8L	5000	50000

**Absolute Maximum Ratings** (@  $T_C = 25^\circ\text{C}$  unless otherwise specified)

Symbol	Parameter	Value	Unit
$V_{DS}$	Drain-to-Source Voltage	40	V
$V_{GS}$	Gate-to-Source Voltage	$\pm 20$	V
$I_D$	Continuous Drain Current	$T_C = 25^\circ\text{C}$	236
		$T_C = 100^\circ\text{C}$	167
$I_{DM}$	Pulsed Drain Current <sup>(1)</sup>	Refer to Fig.4	A
$E_{AS}$	Single Pulsed Avalanche Energy <sup>(2)</sup>	497	mJ
$P_D$	Power Dissipation	$T_C = 25^\circ\text{C}$	192
		$T_C = 100^\circ\text{C}$	96
$T_J, T_{STG}$	Junction & Storage Temperature Range	-55 to 175	$^\circ\text{C}$

**Thermal Characteristics**

Symbol	Parameter	Max	Unit
$R_{\theta JA}$	Thermal Resistance, Junction to Ambient <sup>(3)</sup>	42	$^\circ\text{C/W}$
$R_{\theta JC}$	Thermal Resistance, Junction to Case	0.8	

**Electrical Characteristics** ( $T_J = 25^\circ\text{C}$  unless otherwise specified)

Symbol	Parameter	Conditions	Min.	Typ.	Max.	Unit
<b>Off Characteristics</b>						
$V_{(BR)DSS}$	Drain-Source Breakdown Voltage	$I_D = 250\mu\text{A}, V_{GS} = 0\text{V}$	40	-	-	V
$I_{DSS}$	Zero Gate Voltage Drain Current	$V_{DS} = 32\text{V}, V_{GS} = 0\text{V}$	-	-	1.0	$\mu\text{A}$
$I_{GSS}$	Gate-Body Leakage Current	$V_{DS} = 0\text{V}, V_{GS} = \pm 20\text{V}$	-	-	$\pm 100$	nA
<b>On Characteristics</b>						
$V_{GS(th)}$	Gate Threshold Voltage	$V_{DS} = V_{GS}, I_D = 250\mu\text{A}$	1.2	1.8	2.5	V
$R_{DS(on)}$	Static Drain-Source ON-Resistance <sup>(4)</sup>	$V_{GS} = 10\text{V}, I_D = 20\text{A}$	-	1.3	1.8	m $\Omega$
		$V_{GS} = 4.5\text{V}, I_D = 15\text{A}$	-	1.8	2.4	m $\Omega$
<b>Dynamic Characteristics</b>						
$R_g$	Gate Resistance	$f = 1\text{MHz}$	-	1.9	-	$\Omega$
$C_{iss}$	Input Capacitance	$V_{GS} = 0\text{V}, V_{DS} = 20\text{V}, f = 1\text{MHz}$	-	3953	5340	pF
$C_{oss}$	Output Capacitance		-	975	1320	pF
$C_{riss}$	Reverse Transfer Capacitance		-	46	65	pF
$Q_g$	Total Gate Charge	$V_{GS} = 0 \text{ to } 10\text{V}$ $V_{DS} = 20\text{V}, I_D = 20\text{A}$	-	59	-	nC
$Q_{gs}$	Gate Source Charge		-	12	-	nC
$Q_{gd}$	Gate Drain("Miller") Charge		-	8	-	nC
<b>Switching Characteristics</b>						
$t_{d(on)}$	Turn-On DelayTime	$V_{GS} = 10\text{V}, V_{DD} = 20\text{V}$ $I_D = 20\text{A}, R_{GEN} = 3\Omega$	-	12	-	ns
$t_r$	Turn-On Rise Time		-	31	-	ns
$t_{d(off)}$	Turn-Off DelayTime		-	50	-	ns
$t_f$	Turn-Off Fall Time		-	13	-	ns
<b>Body Diode Characteristics</b>						
$I_S$	Maximum Continuous Body Diode Forward Current		-	-	236	A
$I_{SM}$	Maximum Pulsed Body Diode Forward Current		-	-	946	A
$V_{SD}$	Body Diode Forward Voltage	$V_{GS} = 0\text{V}, I_S = 20\text{A}$	-		1.2	V
$t_{rr}$	Body Diode Reverse Recovery Time	$I_F = 20\text{A}, di/dt = 100\text{A}/\mu\text{s}$	19	39	58	ns
$Q_{rr}$	Body Diode Reverse Recovery Charge		-	36	-	nC

- Notes:
1. Repetitive Rating: Pulse Width Limited by Maximum Junction Temperature.
  2.  $E_{AS}$  condition: Starting  $T_J = 25^\circ\text{C}$ ,  $V_{DD} = 20\text{V}$ ,  $V_{GS} = 10\text{V}$ ,  $R_G = 25\text{ohm}$ ,  $L = 3\text{mH}$ ,  $I_{AS} = 18.2\text{A}$ ,  $V_{DD} = 0\text{V}$  during time in avalanche.
  3.  $R_{\theta JA}$  is measured with the device mounted on a 1inch<sup>2</sup> pad of 2oz copper FR4 PCB.
  4. Pulse Test: Pulse Width  $\leq 300\mu\text{s}$ , Duty Cycle  $\leq 0.5\%$ .



## Typical Performance Characteristics

Figure 1: Power De-rating

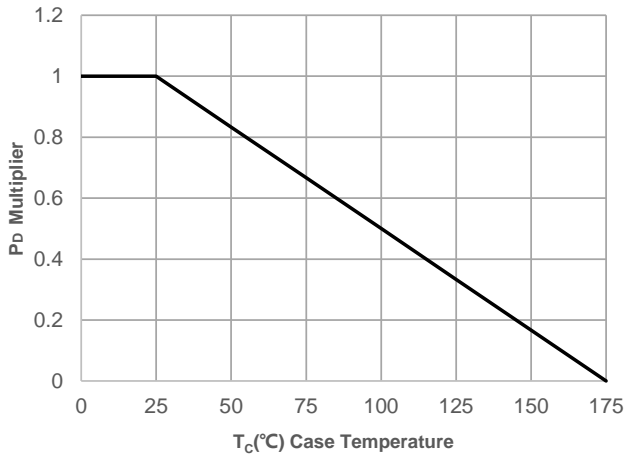

Figure 2: Current De-rating

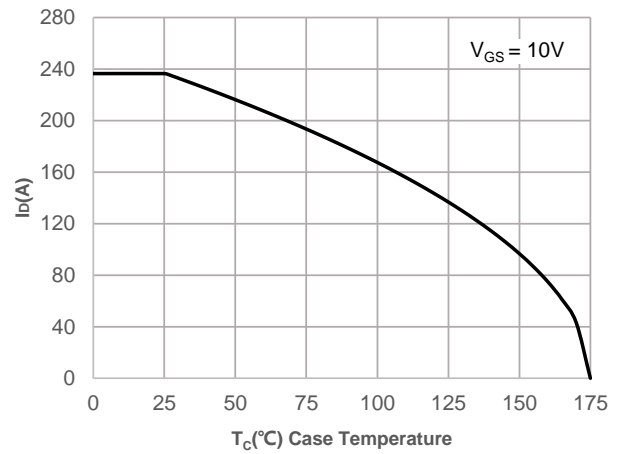

Figure 3: Normalized Maximum Transient Thermal Impedance

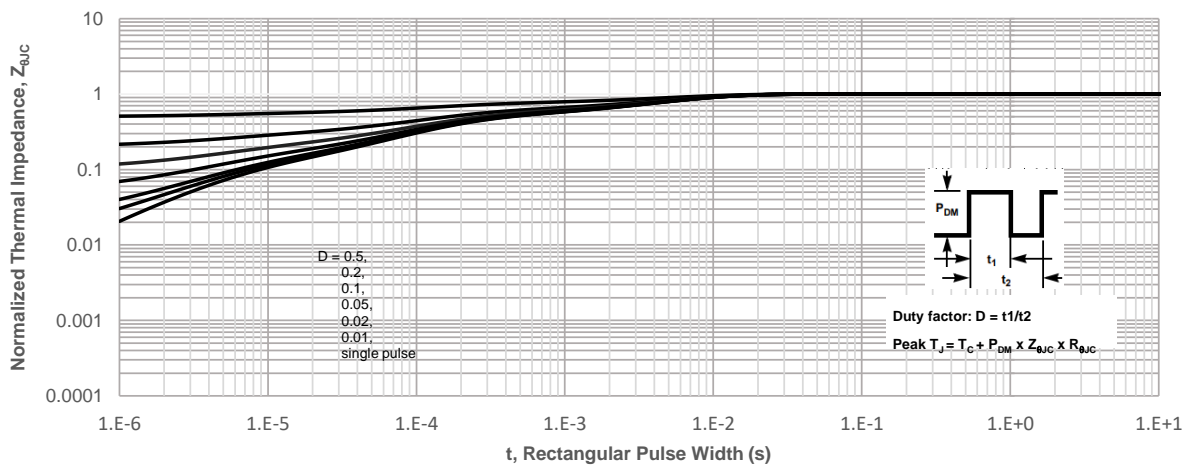
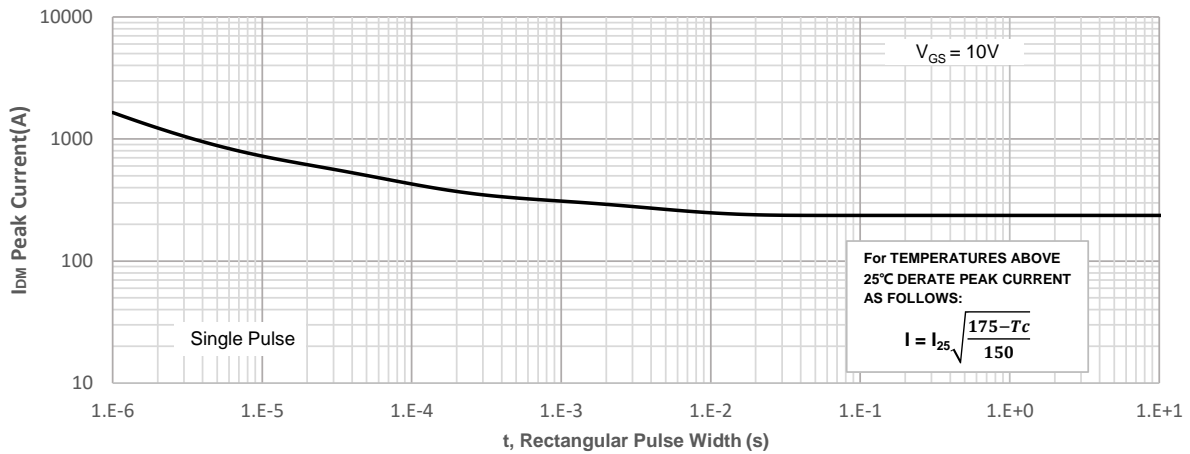

Figure 4: Peak Current Capacity



## Typical Performance Characteristics

Figure 5: Output Characteristics

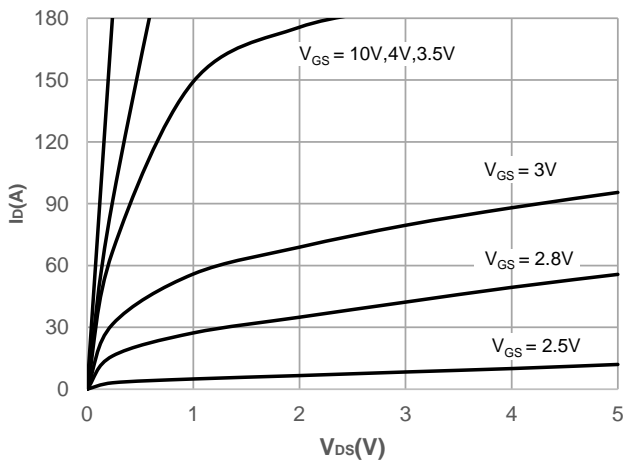

Figure 6: Typical Transfer Characteristics

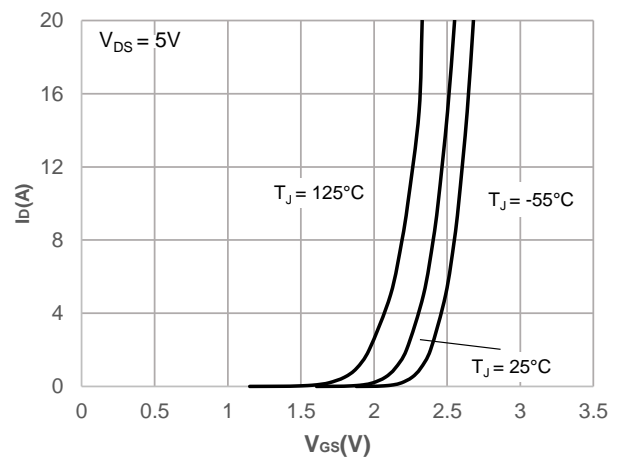

Figure 7: On-resistance vs. Drain Current

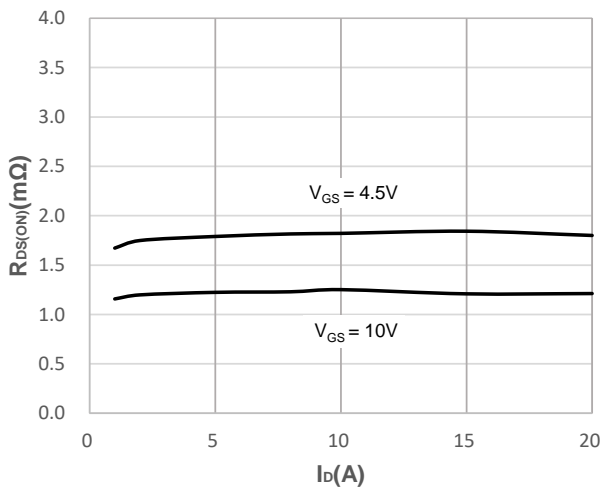

Figure 8: Body Diode Characteristics

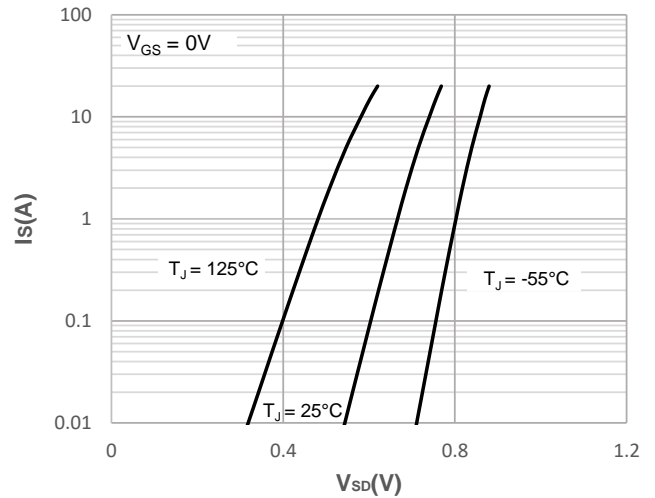

Figure 9: Gate Charge Characteristics

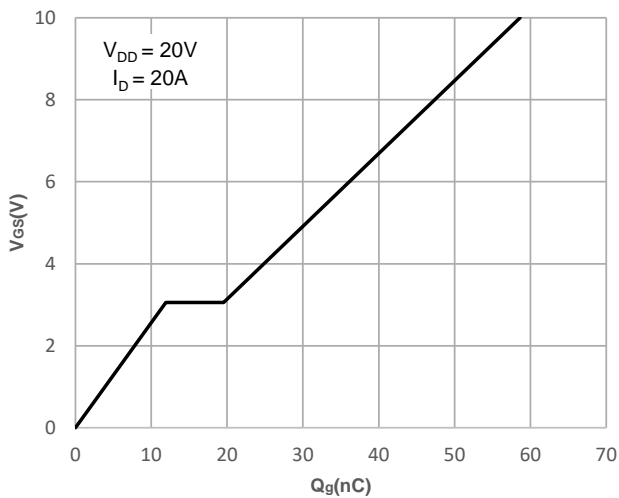
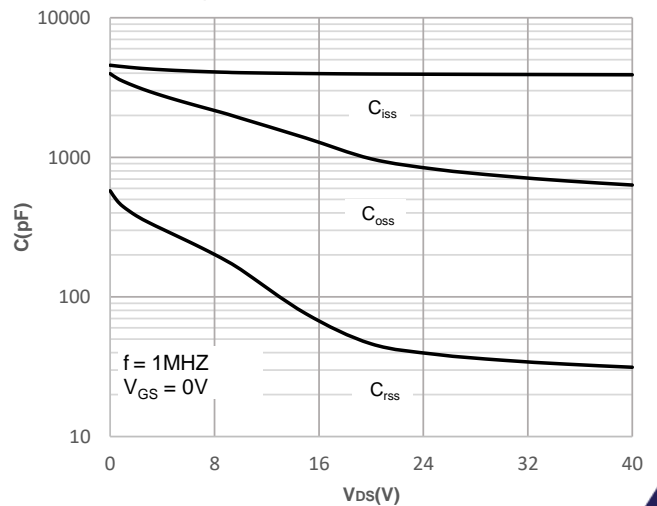

Figure 10: Capacitance Characteristics



## Typical Performance Characteristics

Figure 11: Normalized Breakdown Voltage vs. Junction Temperature

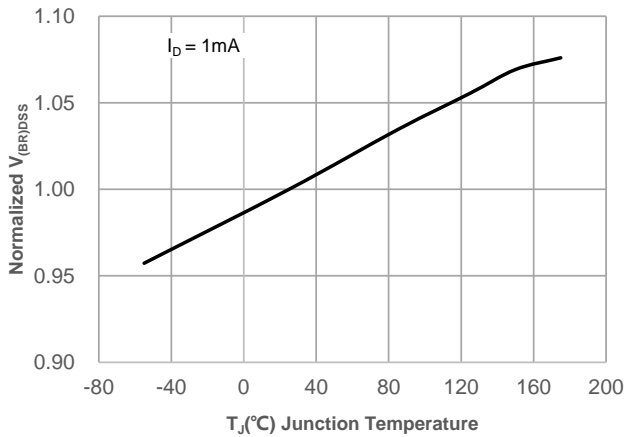

Figure 12: Normalized on Resistance vs. Junction Temperature

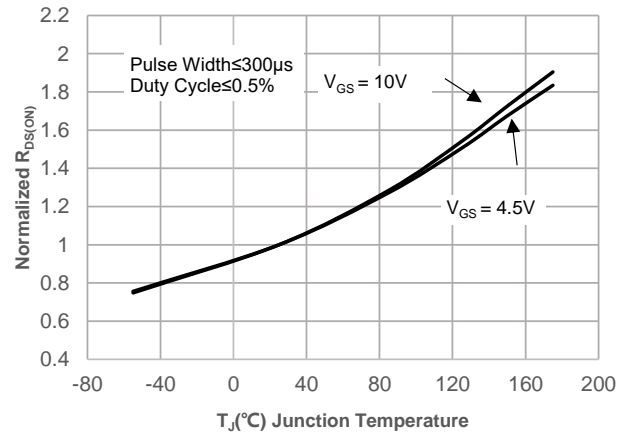

Figure 13: Normalized Threshold Voltage vs. Junction Temperature

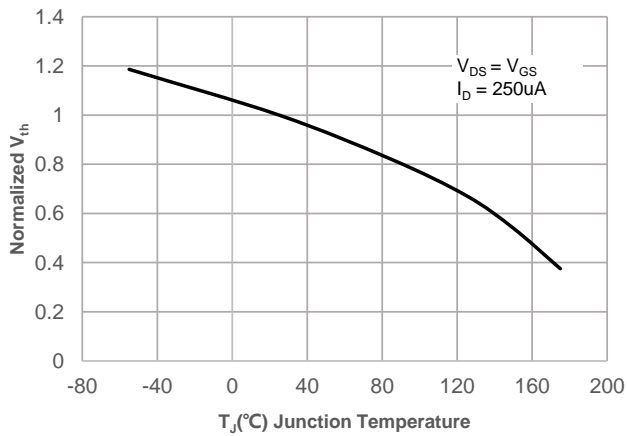

Figure 14:  $R_{DS(ON)}$  vs.  $V_{GS}$

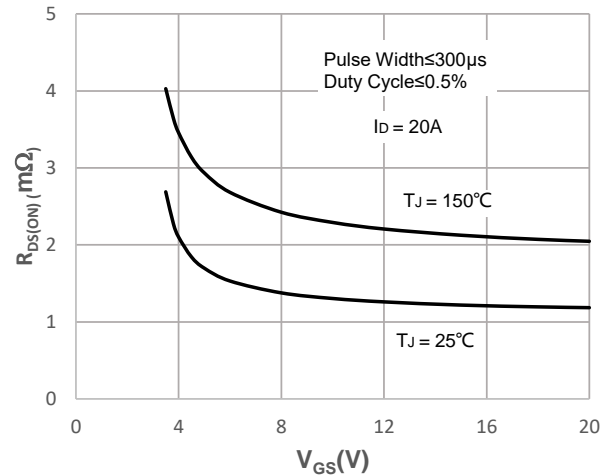
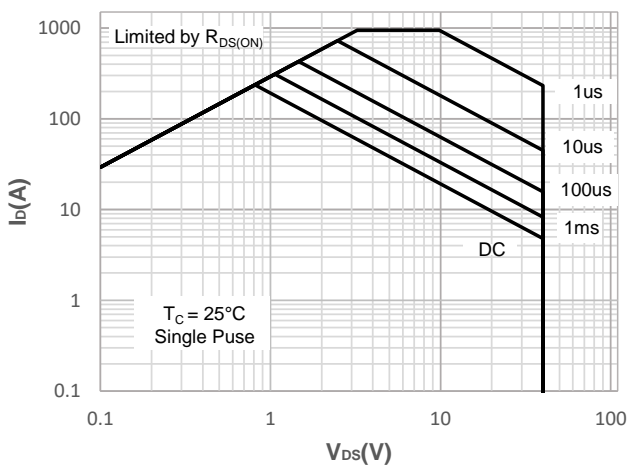

Figure 15: Maximum Safe Operating Area



### Test Circuit

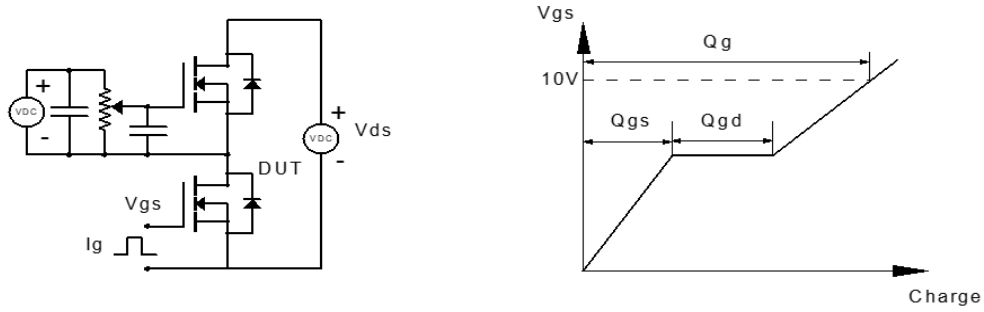

Figure 1: Gate Charge Test Circuit & Waveform

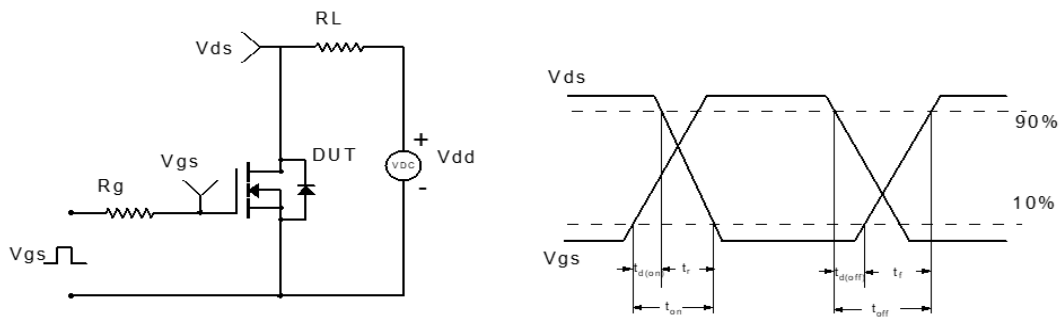

Figure 2: Resistive Switching Test Circuit & Waveform



Figure 3: Unclamped Inductive Switching Test Circuit & Waveform

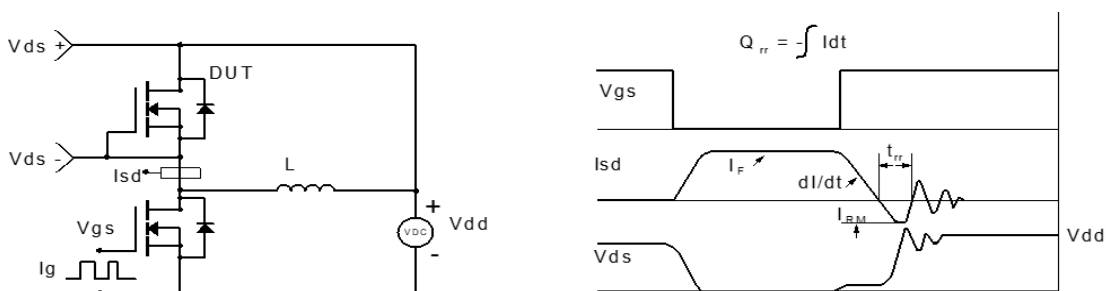
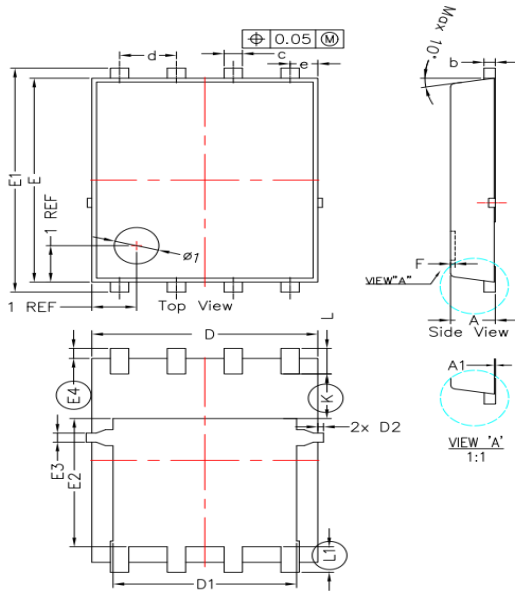

Figure 4: Diode Recovery Test Circuit & Waveform



Package Mechanical Data(PDFN5X6-8L)



SYMBOLS	DIMENSION IN MM			DIMENSION IN INCHES		
	MIN	NOM	MAX	MIN	NOM	MAX
*A	0.900	1.000	1.150	0.035	0.039	0.045
A1	0.000	---	0.050	0.000	---	0.002
b	0.246	0.254	0.350	0.010	0.010	0.014
*C	0.310	0.410	0.510	0.012	0.016	0.020
d	1.27BSC			0.050BSC		
*D	4.950	5.050	5.150	0.195	0.199	0.203
D1	4.000	4.100	4.200	0.157	0.161	0.165
*D2	0.125REF			0.005REF		
e	0.62BSC			0.024BSC		
*E	5.500	5.600	5.700	0.217	0.220	0.224
*E1	6.050	6.150	6.250	0.238	0.242	0.246
E2	3.425	3.525	3.625	0.135	0.139	0.143
E3	0.250REF			0.010REF		
*E4	0.275REF			0.011REF		
F	-	-	0.100	-	-	0.004
*L	0.500	0.600	0.700	0.02	0.02	0.03
L1	0.600	0.700	0.800	0.02	0.03	0.03
K	1.225REF			0.05REF		

Recommended Soldering Footprint

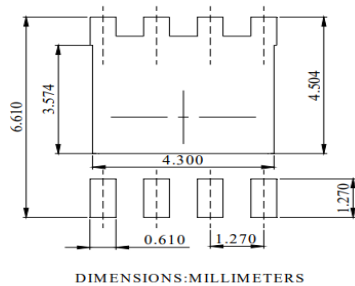

Information furnished in this document is believed to be accurate and reliable. However, Jiangsu JieJie Microelectronics Co.,Ltd assumes no responsibility for the consequences of use without consideration for such information nor use beyond it. Information mentioned in this document is subject to change without notice, apart from that when an agreement is signed, Jiangsu JieJie complies with the agreement. Products and information provided in this document have no infringement of patents. Jiangsu JieJie assumes no responsibility for any infringement of other rights of third parties which may result from the use of such products and information.

is a registered trademark of Jiangsu JieJie Microelectronics Co.,Ltd.

