



-100V 36mΩ P-Ch Power MOSFET

Features

- Low On-Resistance
- Excellent Gate Charge x $R_{DS(ON)}$ Product (FOM)
- Pb-Free Lead Plating
- RoHS and Halogen-Free Compliant
- 100% UIS Tested, 100% R_g Tested

Product Summary

Parameter	Value	Unit
V_{DS}	-100	V
$V_{GS(th_Typ)}$	-2.0	V
I_D (@ $V_{GS} = -10V$) ⁽¹⁾	-36	A
$R_{DS(ON_Typ)}$ (@ $V_{GS} = -10V$)	36	mΩ
$R_{DS(ON_Typ)}$ (@ $V_{GS} = -4.5V$)	50	mΩ

Applications

- Battery Management
- DC/DC in Telecoms and Industrial
- Hard Switching and High Speed Circuit

TO-263-3L Top View

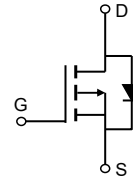
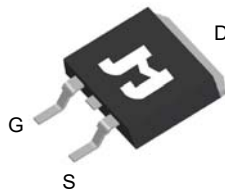

Ordering Information

Device	Package	# of Pins	Marking	MSL	T_J (°C)	Media	Quantity (pcs)
JMPL1050AE-13	TO-263-3L	3	PL1050A	1	-55 to 150	13-inch Reel	800

Absolute Maximum Ratings (@ $T_A = 25^\circ C$ unless otherwise specified)

Parameter	Symbol	Value	Unit
Drain-to-Source Voltage	V_{DS}	-100	V
Gate-to-Source Voltage	V_{GS}	±20	V
Continuous Drain Current ⁽¹⁾	I_D	$T_C = 25^\circ C$	-36
		$T_C = 100^\circ C$	-23
Pulsed Drain Current ⁽²⁾	I_{DM}	-82	A
Avalanche Current ⁽³⁾	I_{AS}	-27	A
Avalanche Energy ⁽³⁾	E_{AS}	109	mJ
Power Dissipation ⁽⁴⁾	P_D	$T_C = 25^\circ C$	125
		$T_C = 100^\circ C$	50
Junction & Storage Temperature Range	T_J, T_{STG}	-55 to 150	°C

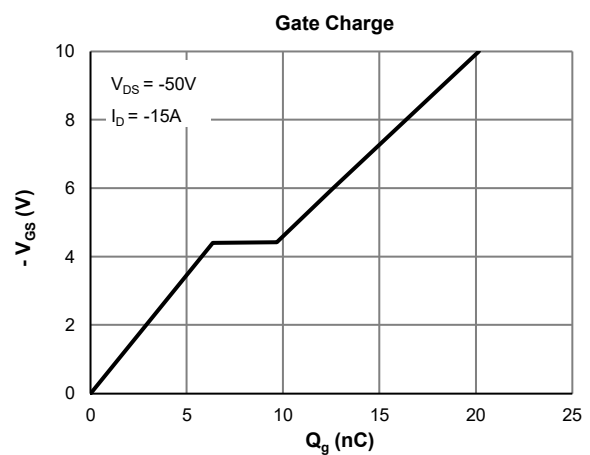
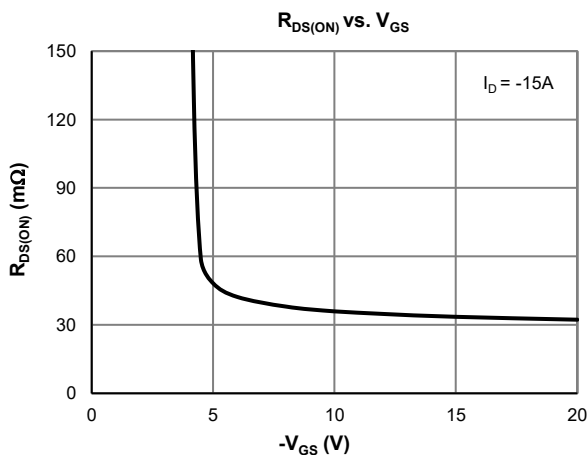



Electrical Characteristics (@ $T_J = 25^\circ\text{C}$ unless otherwise specified)

Parameter	Symbol	Conditions	Min.	Typ.	Max.	Unit
STATIC PARAMETERS						
Drain-Source Breakdown Voltage	$V_{(BR)DSS}$	$I_D = -250\mu\text{A}, V_{GS} = 0\text{V}$	-100			V
Zero Gate Voltage Drain Current	I_{DSS}	$V_{DS} = -80\text{V}, V_{GS} = 0\text{V}$			-1.0	μA
		$T_J = 55^\circ\text{C}$			-5.0	
Gate-Body Leakage Current	I_{GSS}	$V_{DS} = 0\text{V}, V_{GS} = \pm 20\text{V}$			± 100	nA
Gate Threshold Voltage	$V_{GS(th)}$	$V_{DS} = V_{GS}, I_D = -250\mu\text{A}$	-1.0	-2.0	-3.0	V
Static Drain-Source ON-Resistance	$R_{DS(ON)}$	$V_{GS} = -10\text{V}, I_D = -15\text{A}$		36	50	$\text{m}\Omega$
		$V_{GS} = -4.5\text{V}, I_D = -10\text{A}$		50	66	$\text{m}\Omega$
Forward Transconductance	g_{FS}	$V_{DS} = -5\text{V}, I_D = -15\text{A}$		30		S
Diode Forward Voltage	V_{SD}	$I_S = -1\text{A}, V_{GS} = 0\text{V}$		-0.7	-1.0	V
Diode Continuous Current	I_S	$T_C = 25^\circ\text{C}$			-125	A

DYNAMIC PARAMETERS ⁽⁵⁾

Input Capacitance	C_{iss}	$V_{GS} = 0\text{V}, V_{DS} = -50\text{V}, f = 1\text{MHz}$		1412		pF
Output Capacitance	C_{oss}			222		pF
Reverse Transfer Capacitance	C_{rss}			2.6		pF
Gate Resistance	R_g	$V_{GS} = 0\text{V}, V_{DS} = 0\text{V}, f = 1\text{MHz}$		10.2		Ω

SWITCHING PARAMETERS ⁽⁵⁾

Total Gate Charge (@ $V_{GS} = -10\text{V}$)	Q_g	$V_{GS} = 0 \text{ to } -10\text{V}$ $V_{DS} = -50\text{V}, I_D = -15\text{A}$		20		nC
Total Gate Charge (@ $V_{GS} = -6.0\text{V}$)	Q_g			12.6		nC
Gate Source Charge	Q_{gs}			6.4		nC
Gate Drain Charge	Q_{gd}			3.3		nC
Turn-On DelayTime	$t_{D(on)}$	$V_{GS} = -10\text{V}, V_{DS} = -50\text{V}$ $R_L = 3.3\Omega, R_{GEN} = 6\Omega$		10.7		ns
Turn-On Rise Time	t_r			56		ns
Turn-Off DelayTime	$t_{D(off)}$			45		ns
Turn-Off Fall Time	t_f			81		ns
Body Diode Reverse Recovery Time	t_{rr}		$I_F = -15\text{A}, di_F/dt = -100\text{A}/\mu\text{s}$		51	
Body Diode Reverse Recovery Charge	Q_{rr}	$I_F = -15\text{A}, di_F/dt = -100\text{A}/\mu\text{s}$		130		nC

Thermal Performance

Parameter	Symbol	Typ.	Max.	Unit
Thermal Resistance, Junction-to-Ambient	$R_{\theta JA}$	47	56	$^\circ\text{C}/\text{W}$
Thermal Resistance, Junction-to-Case	$R_{\theta JC}$	0.80	1.0	$^\circ\text{C}/\text{W}$

Notes:

1. Computed continuous current assumes the condition of T_{J_Max} while the actual continuous current depends on the thermal & electro-mechanical application board design.
2. This single-pulse measurement was taken under $T_{J_Max} = 150^\circ\text{C}$.
3. This single-pulse measurement was taken under the following condition [$L = 300\mu\text{H}, V_{GS} = -10\text{V}, V_{DD} = -50\text{V}$] while its value is limited by $T_{J_Max} = 150^\circ\text{C}$.
4. The power dissipation P_D is based on $T_{J_Max} = 150^\circ\text{C}$.
5. This value is guaranteed by design hence it is not included in the production test.

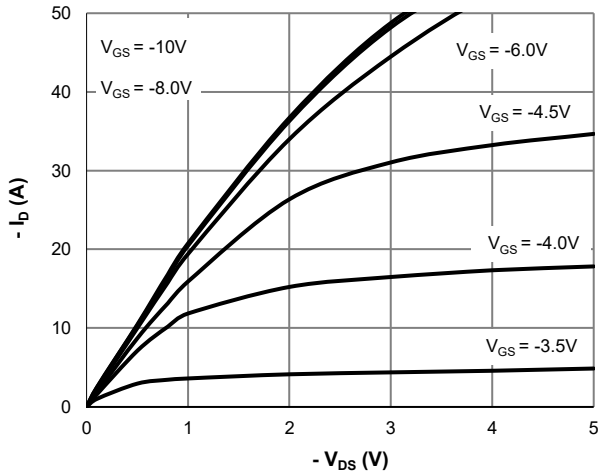
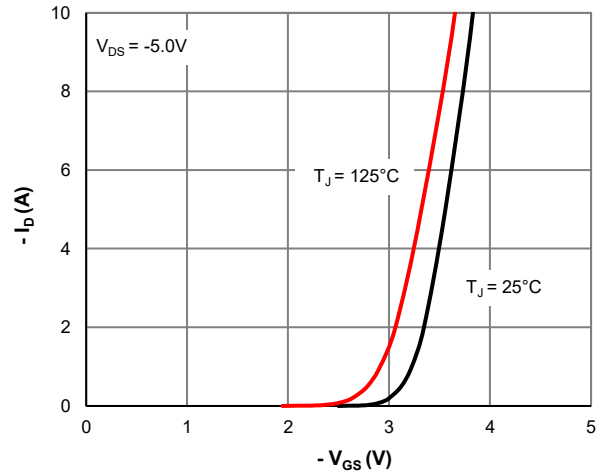
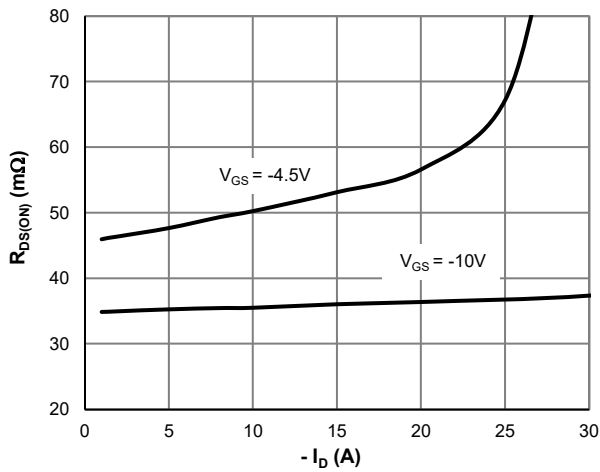
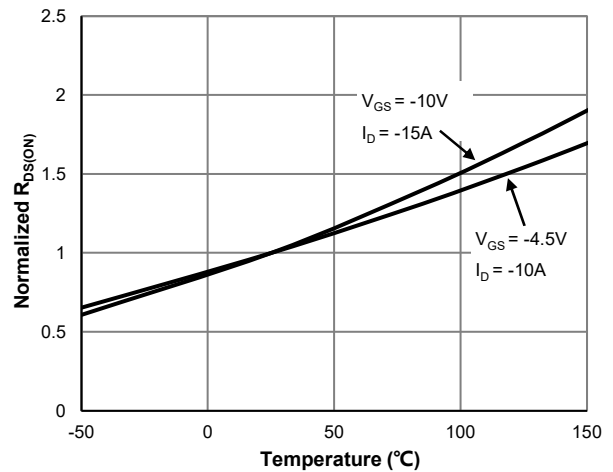
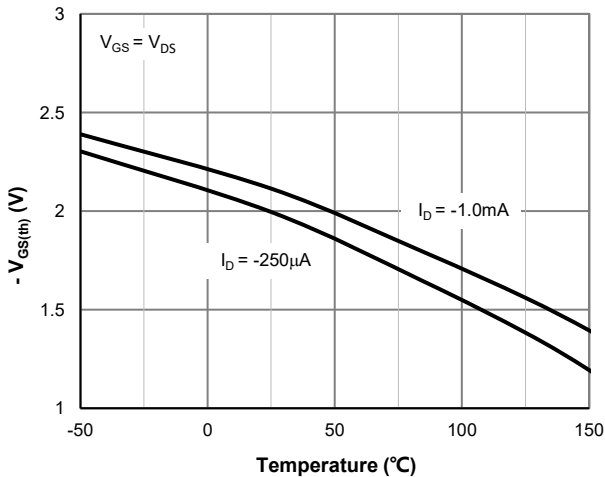
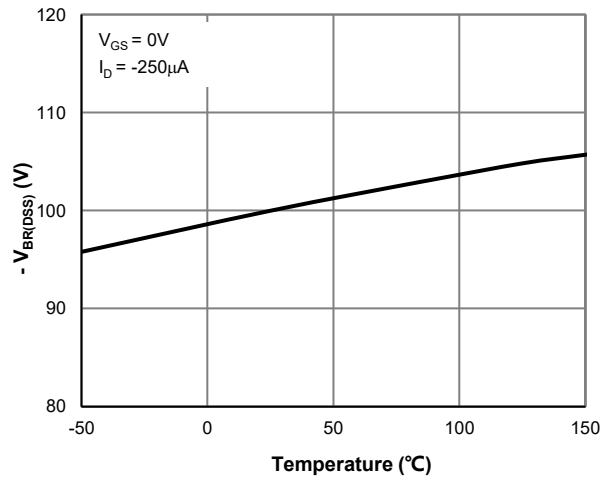
Typical Electrical & Thermal Characteristics

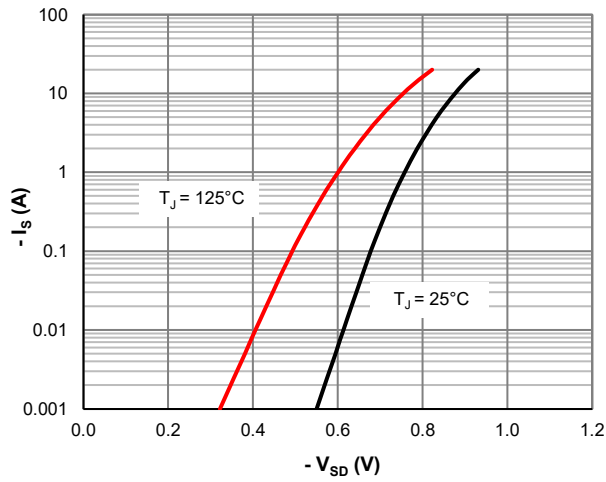
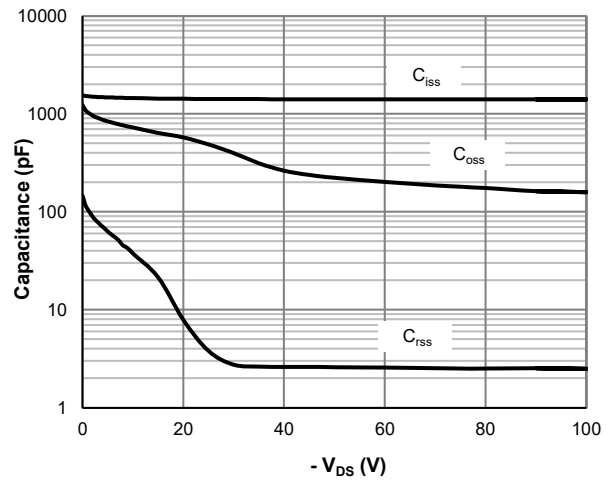
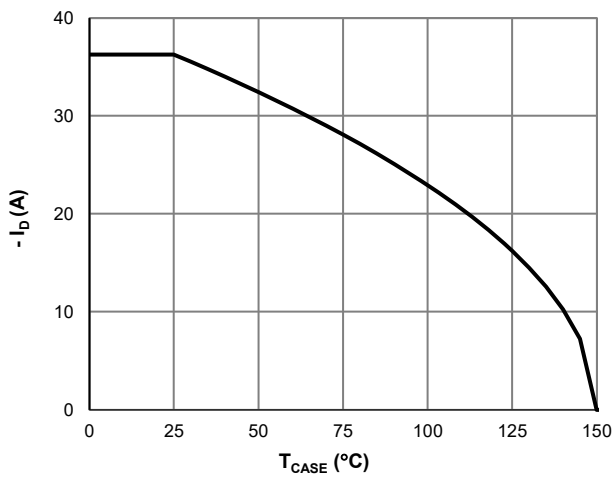
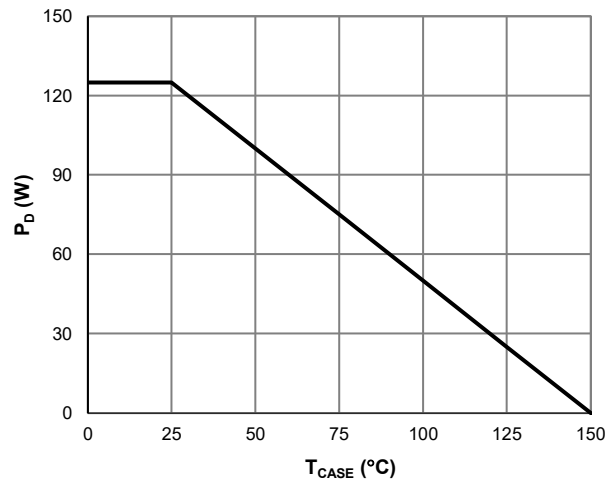
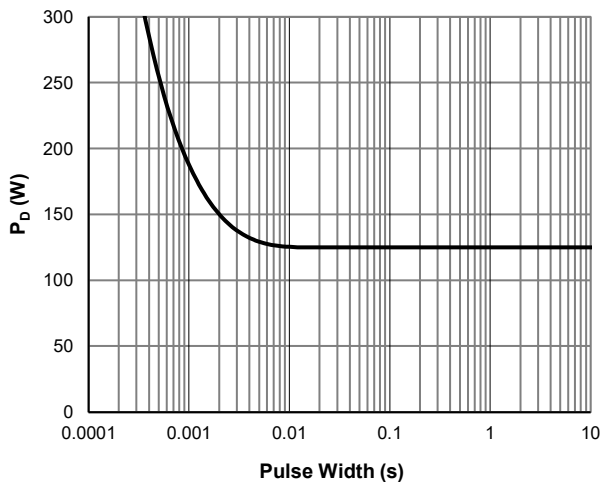
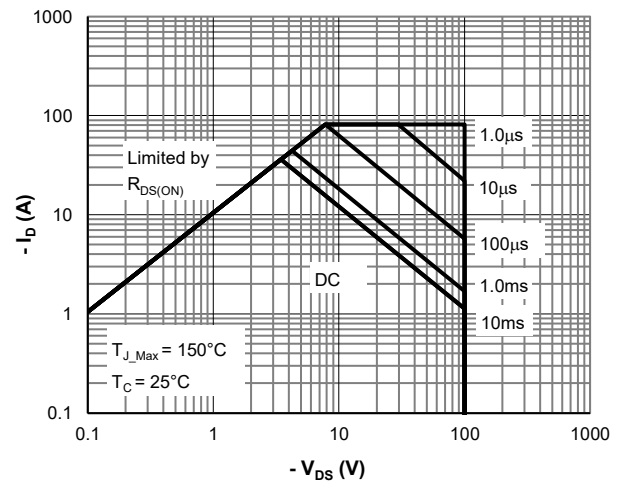
Figure 1: Saturation Characteristics

Figure 2: Transfer Characteristics

Figure 3: $R_{DS(ON)}$ vs. Drain Current

Figure 4: $R_{DS(ON)}$ vs. Junction Temperature

Figure 5: $V_{GS(th)}$ vs. Junction Temperature

Figure 6: $V_{BR(DSS)}$ vs. Junction Temperature

Typical Electrical & Thermal Characteristics

Figure 7: Body-Diode Characteristics

Figure 8: Capacitance Characteristics

Figure 9: Current De-rating

Figure 10: Power De-rating

Figure 11: Single Pulse Power Rating, Junction-to-Case

Figure 12: Maximum Safe Operating Area



Typical Electrical & Thermal Characteristics

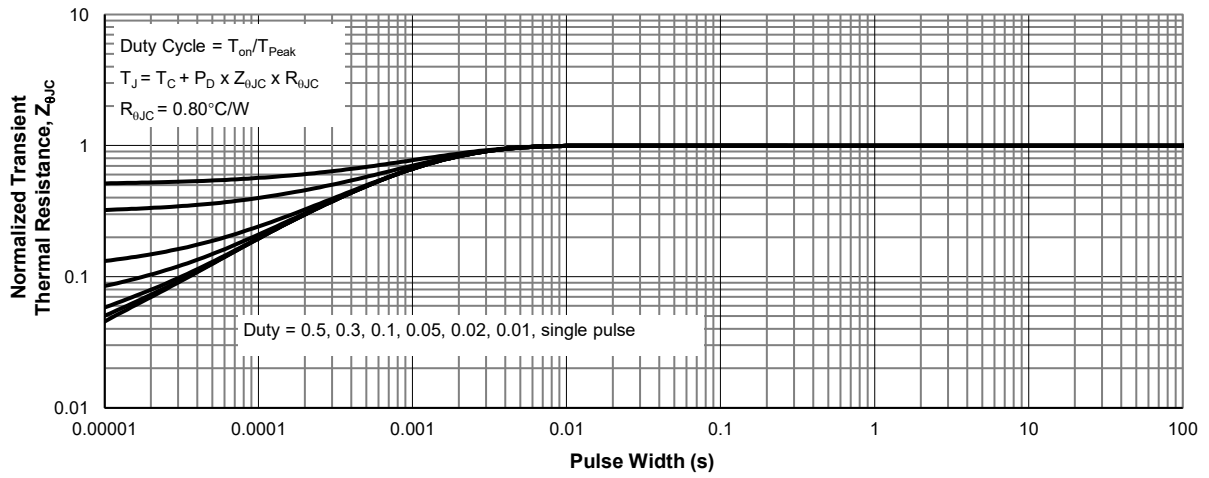
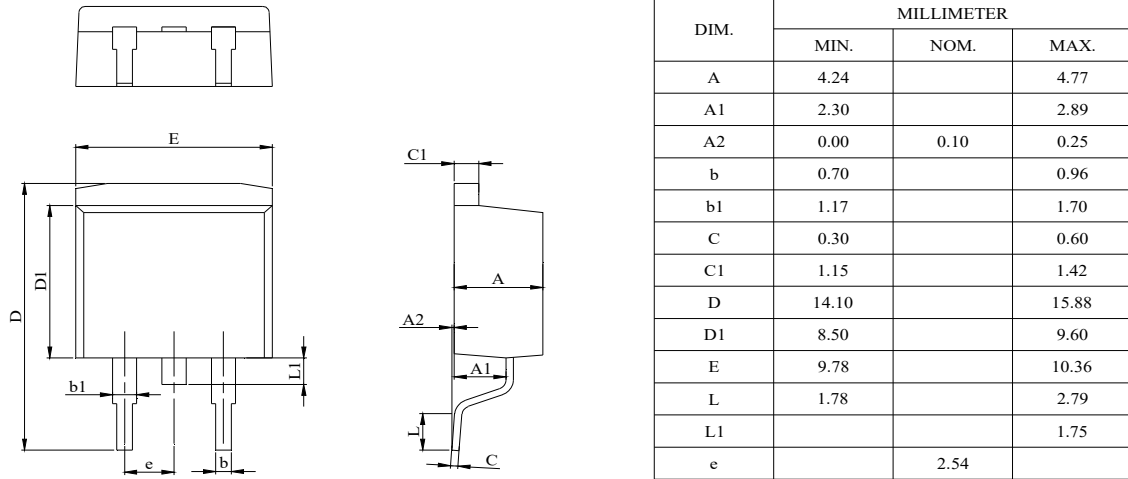

Figure 13: Normalized Maximum Transient Thermal Impedance

TO-263-3L Package Information
Package Outline

Recommend Soldering Footprint
