



-100V 36mΩ P-Ch Power MOSFET

Features

- Low On-Resistance
- Excellent Gate Charge x $R_{DS(ON)}$ Product (FOM)
- Pb-Free Lead Plating
- RoHS and Halogen-Free Compliant
- 100% UIS Tested, 100% R_g Tested

Product Summary

Parameter	Value	Unit
V_{DS}	-100	V
$V_{GS(th_Typ)}$	-2.0	V
I_D (@ $V_{GS} = -10V$) ⁽¹⁾	-27	A
$R_{DS(ON_Typ)}$ (@ $V_{GS} = -10V$)	36	mΩ
$R_{DS(ON_Typ)}$ (@ $V_{GS} = -4.5V$)	48	mΩ

Applications

- Battery Management
- DC/DC in Telecoms and Industrial
- Hard Switching and High Speed Circuit

PDFN5x6-8L

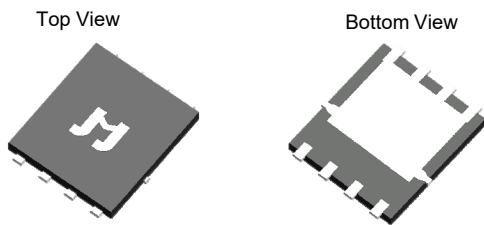

Pin Configuration
Top View

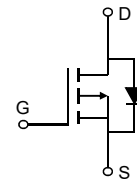
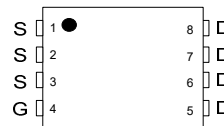

Ordering Information

Device	Package	# of Pins	Marking	MSL	T_J (°C)	Media	Quantity (pcs)
JMPL1050AG-13	PDFN5x6-8L	8	PL1050A	1	-55 to 150	13-inch Reel	3000

Absolute Maximum Ratings (@ $T_A = 25^\circ C$ unless otherwise specified)

Parameter	Symbol	Value	Unit
Drain-to-Source Voltage	V_{DS}	-100	V
Gate-to-Source Voltage	V_{GS}	±20	V
Continuous Drain Current ⁽¹⁾	I_D	$T_C = 25^\circ C$	-27
		$T_C = 100^\circ C$	-17
Pulsed Drain Current ⁽²⁾	I_{DM}	-82	A
Avalanche Current ⁽³⁾	I_{AS}	-27	A
Avalanche Energy ⁽³⁾	E_{AS}	109	mJ
Power Dissipation ⁽⁴⁾	P_D	$T_C = 25^\circ C$	78
		$T_C = 100^\circ C$	31
Junction & Storage Temperature Range	T_J, T_{STG}	-55 to 150	°C

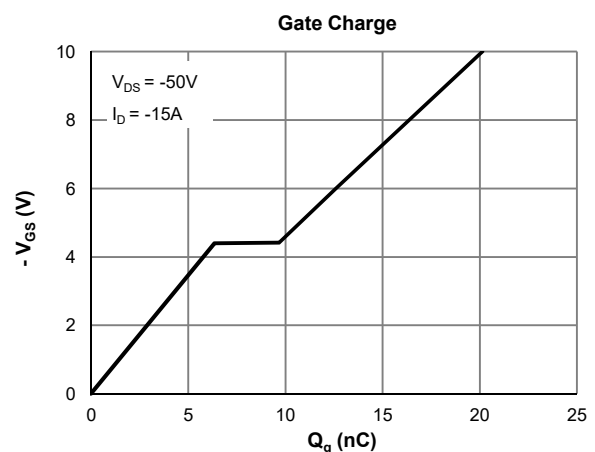
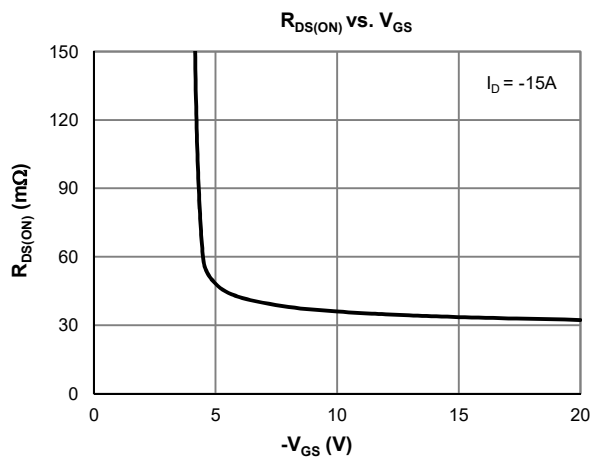



Electrical Characteristics (@ T_J = 25°C unless otherwise specified)

Parameter	Symbol	Conditions	Min.	Typ.	Max.	Unit
STATIC PARAMETERS						
Drain-Source Breakdown Voltage	V _{(BR)DSS}	I _D = -250μA, V _{GS} = 0V	-100			V
Zero Gate Voltage Drain Current	I _{DSS}	V _{DS} = -80V, V _{GS} = 0V T _J = 55°C			-1.0 -5.0	μA
Gate-Body Leakage Current	I _{GSS}	V _{DS} = 0V, V _{GS} = ±20V			±100	nA
Gate Threshold Voltage	V _{GS(th)}	V _{DS} = V _{GS} , I _D = -250μA	-1.0	-2.0	-3.0	V
Static Drain-Source ON-Resistance	R _{DS(ON)}	V _{GS} = -10V, I _D = -15A		36	50	mΩ
		V _{GS} = -4.5V, I _D = -10A		48	65	mΩ
Forward Transconductance	g _{FS}	V _{DS} = -5V, I _D = -15A		30		S
Diode Forward Voltage	V _{SD}	I _S = -1A, V _{GS} = 0V		-0.7	-1.0	V
Diode Continuous Current	I _S	T _C = 25°C			-78	A

DYNAMIC PARAMETERS ⁽⁵⁾

Input Capacitance	C _{iss}	V _{GS} = 0V, V _{DS} = -50V, f = 1MHz		1412		pF
Output Capacitance	C _{oss}			222		pF
Reverse Transfer Capacitance	C _{rss}			2.6		pF
Gate Resistance	R _g	V _{GS} = 0V, V _{DS} = 0V, f = 1MHz		10.2		Ω

SWITCHING PARAMETERS ⁽⁵⁾

Total Gate Charge (@ V _{GS} = -10V)	Q _g	V _{GS} = 0 to -10V V _{DS} = -50V, I _D = -15A		20		nC
Total Gate Charge (@ V _{GS} = -6.0V)	Q _g			12.6		nC
Gate Source Charge	Q _{gs}			6.4		nC
Gate Drain Charge	Q _{gd}			3.3		nC
Turn-On DelayTime	t _{D(on)}	V _{GS} = -10V, V _{DS} = -50V R _L = 3.3Ω, R _{GEN} = 6Ω		10.7		ns
Turn-On Rise Time	t _r			56		ns
Turn-Off DelayTime	t _{D(off)}			45		ns
Turn-Off Fall Time	t _f			81		ns
Body Diode Reverse Recovery Time	t _{rr}		I _F = -15A, dI _F /dt = -100A/μS		51	
Body Diode Reverse Recovery Charge	Q _{rr}	I _F = -15A, dI _F /dt = -100A/μS		130		nC

Thermal Performance

Parameter	Symbol	Typ.	Max.	Unit
Thermal Resistance, Junction-to-Ambient	R _{θJA}	47	55	°C/W
Thermal Resistance, Junction-to-Case	R _{θJC}	1.2	1.6	°C/W

Notes:

1. Computed continuous current assumes the condition of T_{J,Max} while the actual continuous current depends on the thermal & electro-mechanical application board design.
2. This single-pulse measurement was taken under T_{J,Max} = 150°C.
3. This single-pulse measurement was taken under the following condition [L = 300μH, V_{GS} = -10V, V_{DD} = -50V] while its value is limited by T_{J,Max} = 150°C.
4. The power dissipation P_D is based on T_{J,Max} = 150°C.
5. This value is guaranteed by design hence it is not included in the production test.

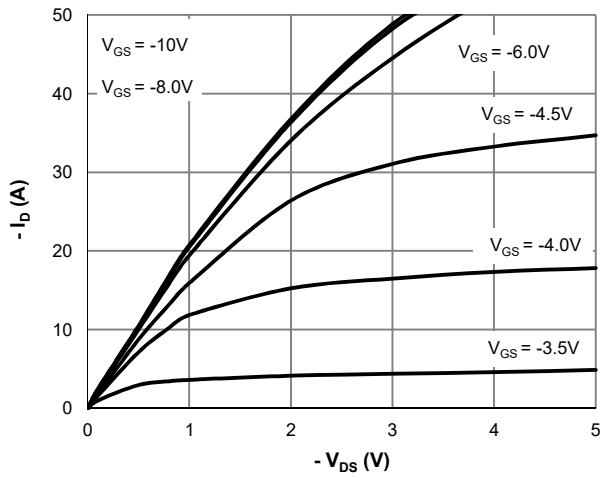
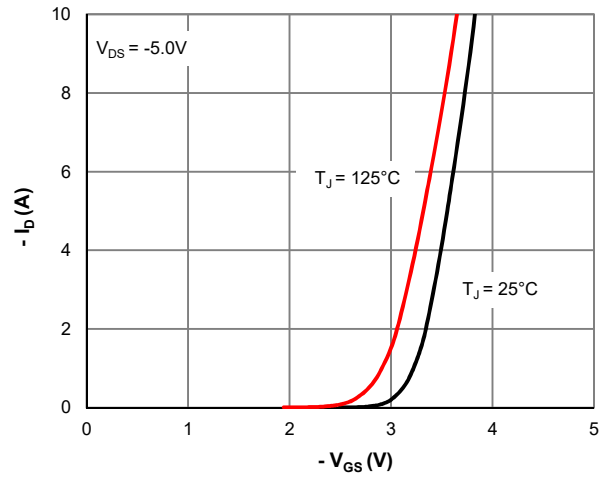
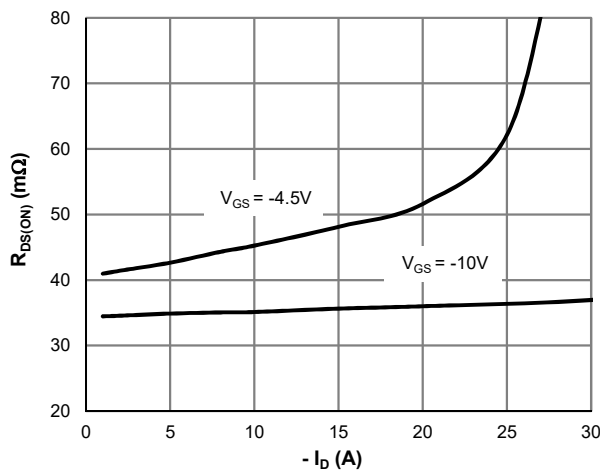
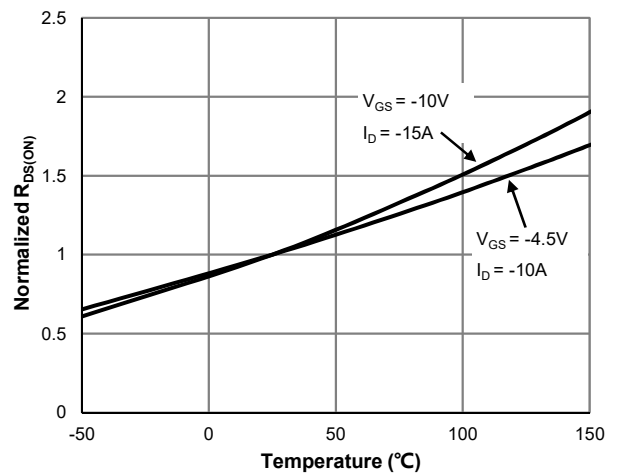
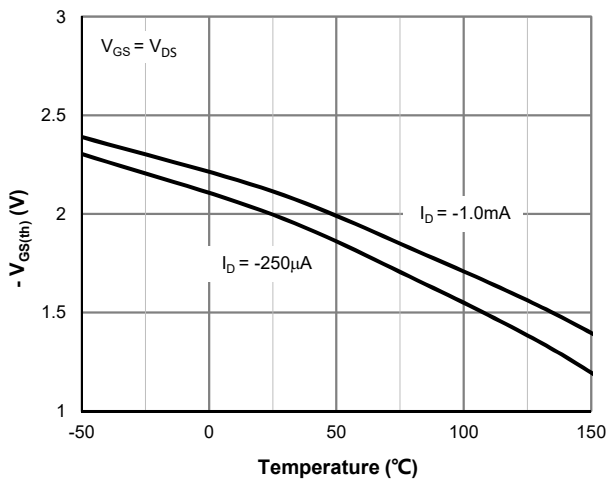
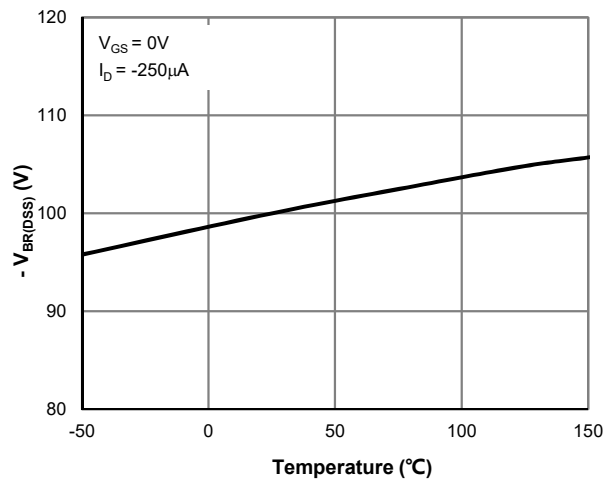
Typical Electrical & Thermal Characteristics

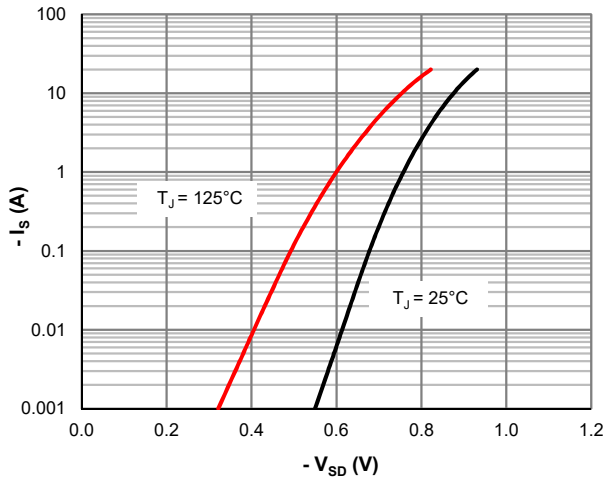
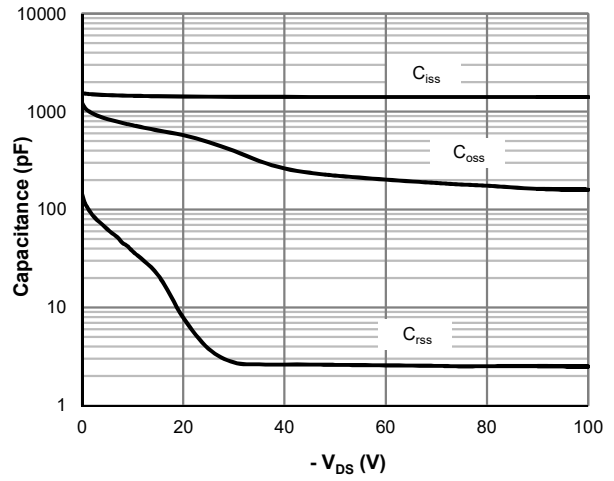
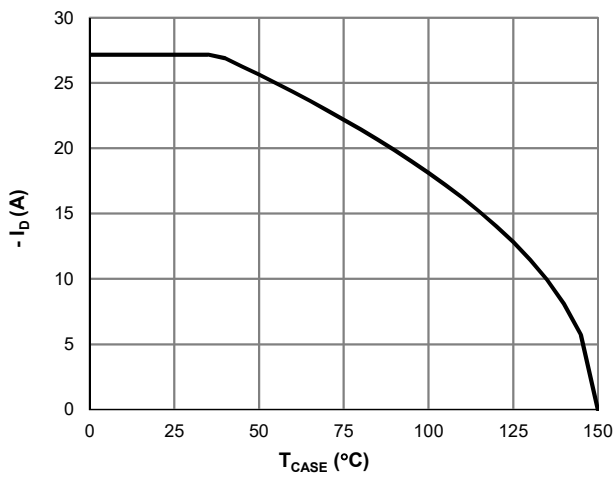
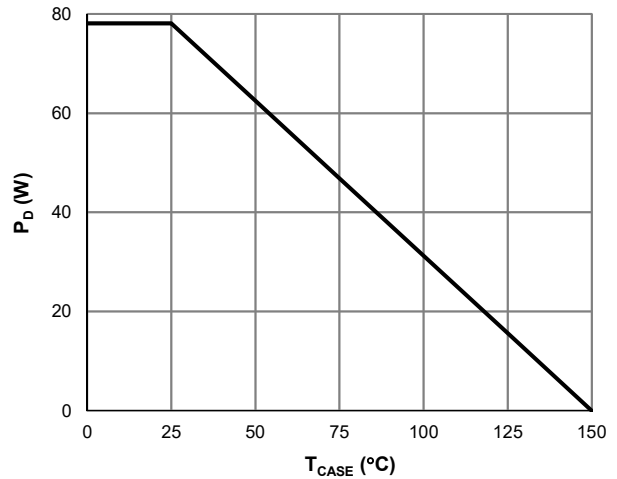
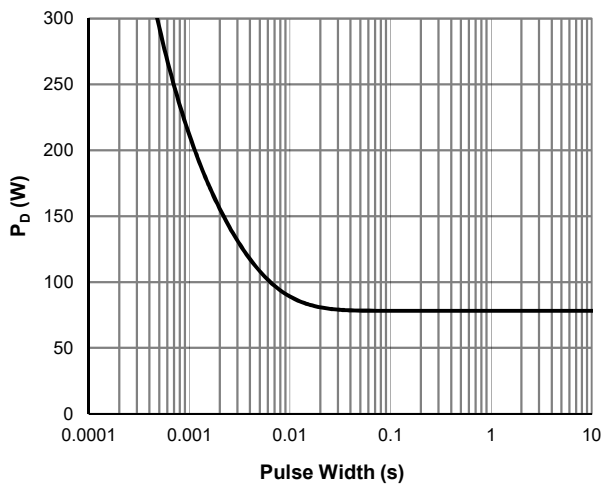
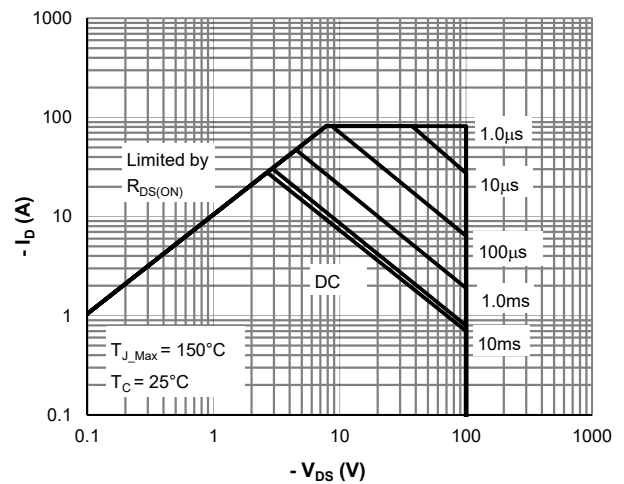
Figure 1: Saturation Characteristics

Figure 2: Transfer Characteristics

Figure 3: $R_{DS(ON)}$ vs. Drain Current

Figure 4: $R_{DS(ON)}$ vs. Junction Temperature

Figure 5: $V_{GS(th)}$ vs. Junction Temperature

Figure 6: $V_{BR(DSS)}$ vs. Junction Temperature

Typical Electrical & Thermal Characteristics

Figure 7: Body-Diode Characteristics

Figure 8: Capacitance Characteristics

Figure 9: Current De-rating

Figure 10: Power De-rating

Figure 11: Single Pulse Power Rating, Junction-to-Case

Figure 12: Maximum Safe Operating Area



Typical Electrical & Thermal Characteristics

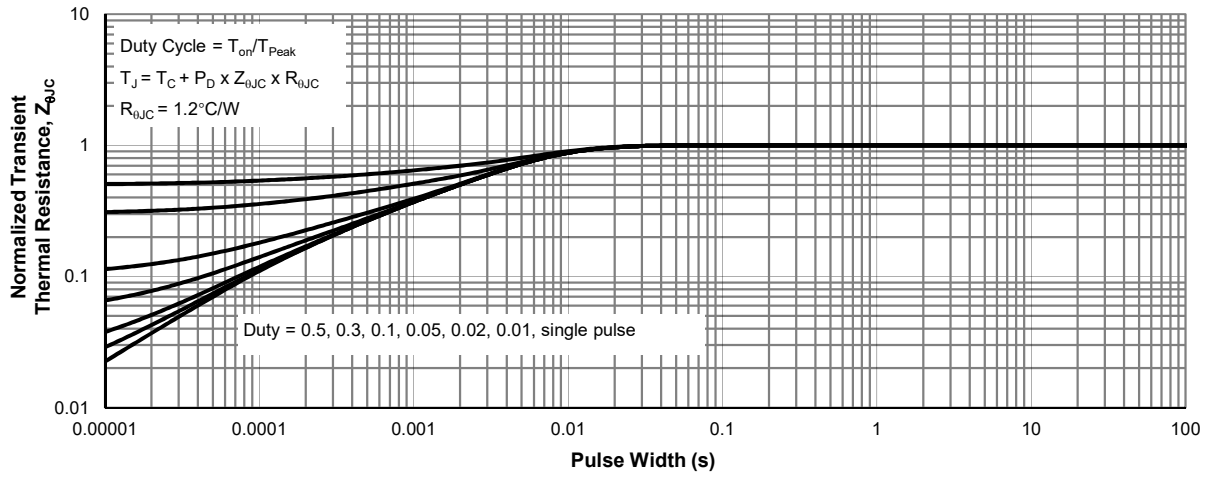
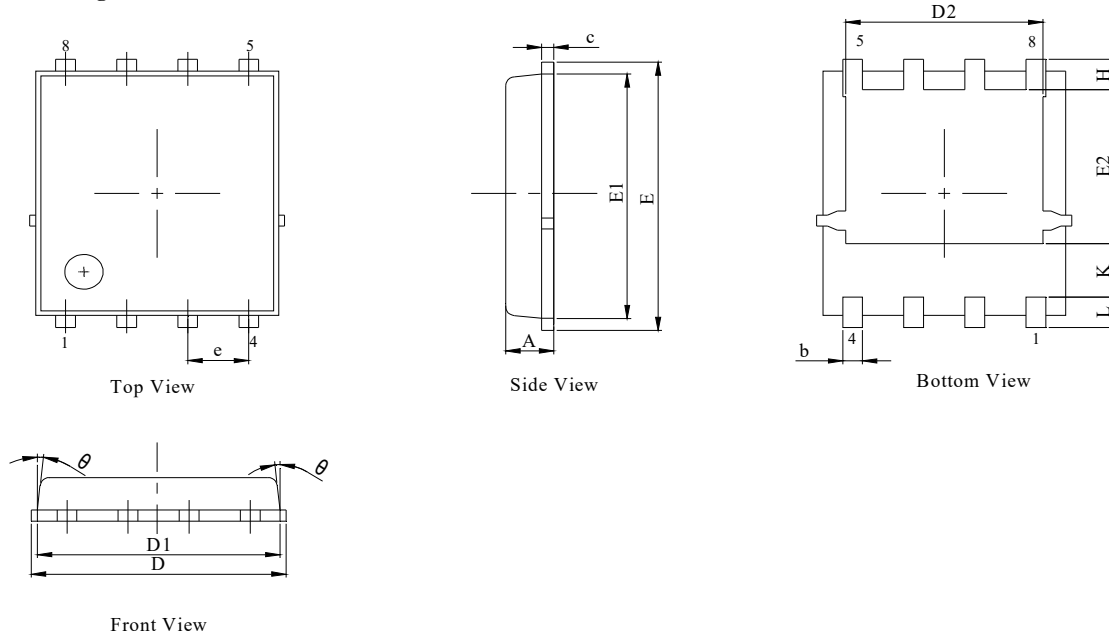
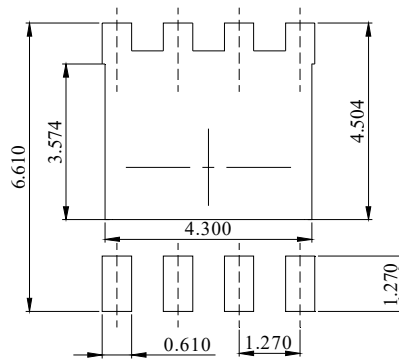

Figure 13: Normalized Maximum Transient Thermal Impedance

PDFN5x6-8L Package Information
Package Outline

NOTES:

1. Dimension and tolerance per ASME Y14.5M, 1994.
2. All dimensions in millimeter (angle in degree).
3. Dimensions D1 and E1 do not include mold flash protrusions or gate burrs.

DIM.	MILLIMETER		
	MIN.	NOM.	MAX.
A	0.90	1.00	1.10
b	0.31	0.41	0.51
c	0.20	0.25	0.30
D	5.00	5.20	5.40
D1	4.95	5.05	5.15
D2	4.00	4.10	4.20
E	6.05	6.15	6.25
E1	5.50	5.60	5.70
E2	3.42	3.53	3.63
e	1.27BSC		
H	0.60	0.70	0.80
L	0.50	0.70	0.80
K	1.23 REF		
θ	-	-	10°

Recommended Soldering Footprint

DIMENSIONS: MILLIMETERS