

## 40V 1.3mΩ N-Ch Power MOSFET

**Features**

- Ultra-low ON-resistance,  $R_{DS(ON)}$
- Low Gate Charge,  $Q_g$
- 100% UIS and  $R_g$  Tested
- Pb-free Lead Plating
- Halogen-free and RoHS-compliant
- AEC-Q101 Qualified for Automotive Applications

**Product Summary**

| Parameter                                | Value | Unit |
|--|-------|------|
| $V_{DS}$                                 | 40    | V    |
| $V_{GS(th\_Typ)}$                        | 2.8   | V    |
| $I_D$ (@ $V_{GS} = 10V$ ) <sup>(1)</sup> | 197   | A    |
| $R_{DS(ON\_Typ)}$ (@ $V_{GS} = 10V$ )    | 1.3   | mΩ   |

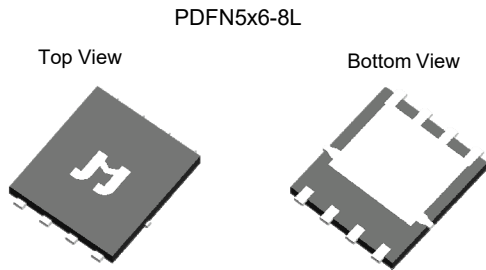

Pin Configuration  
Top View

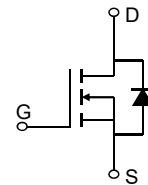
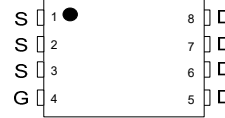
**Ordering Information**

| Device         | Package    | # of Pins | Marking  | MSL | $T_J$ (°C) | Media        | Quantity (pcs) |
|----------------|------------|-----------|----------|-----|------------|--------------|----------------|
| JMSH0401AGQ-13 | PDFN5x6-8L | 8         | SH0401AQ | 1   | -55 to 175 | 13-inch Reel | 3000           |

**Absolute Maximum Ratings** (@  $T_A = 25^\circ\text{C}$  unless otherwise specified)

| Parameter                               | Symbol         | Value                     | Unit |
|---|----------------|---------------------------|------|
| Drain-to-Source Voltage                 | $V_{DS}$       | 40                        | V    |
| Gate-to-Source Voltage                  | $V_{GS}$       | ±20                       | V    |
| Continuous Drain Current <sup>(1)</sup> | $I_D$          | $T_C = 25^\circ\text{C}$  | 197  |
|   |                | $T_C = 100^\circ\text{C}$ | 139  |
| Pulsed Drain Current <sup>(2)</sup>     | $I_{DM}$       | 748                       | A    |
| Avalanche Current <sup>(3)</sup>        | $I_{AS}$       | 36                        | A    |
| Avalanche Energy <sup>(3)</sup>         | $E_{AS}$       | 194                       | mJ   |
| Power Dissipation <sup>(4)</sup>        | $P_D$          | $T_C = 25^\circ\text{C}$  | 136  |
|   |                | $T_C = 100^\circ\text{C}$ | 68   |
| Junction & Storage Temperature Range    | $T_J, T_{STG}$ | -55 to 175                | °C   |

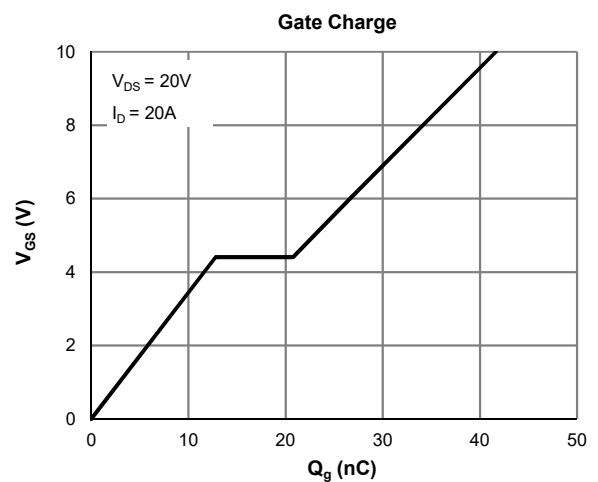
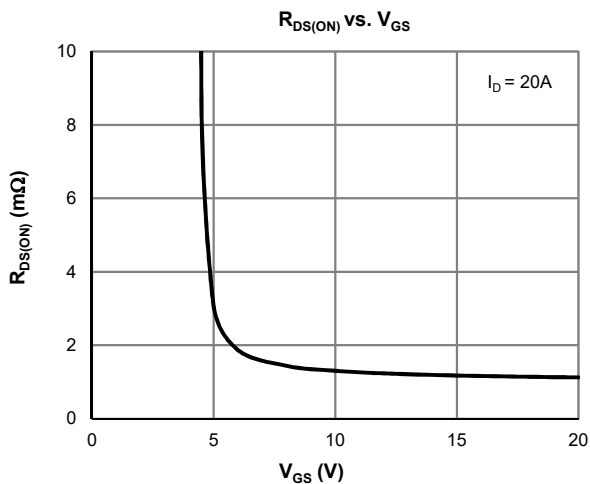



**Electrical Characteristics** (@  $T_J = 25^\circ\text{C}$  unless otherwise specified)

| Parameter                         | Symbol        | Conditions                                    | Min. | Typ. | Max.      | Unit             |
|-----------------------------------|---------------|---|------|------|-----------|------------------|
| <b>STATIC PARAMETERS</b>          |               |   |      |      |           |                  |
| Drain-Source Breakdown Voltage    | $V_{(BR)DSS}$ | $I_D = 250\mu\text{A}, V_{GS} = 0\text{V}$    | 40   |      |           | V                |
| Zero Gate Voltage Drain Current   | $I_{DSS}$     | $V_{DS} = 32\text{V}, V_{GS} = 0\text{V}$     |      |      | 1.0       | $\mu\text{A}$    |
|                                   |               |   |      |      | 5.0       |                  |
| Gate-Body Leakage Current         | $I_{GSS}$     | $V_{DS} = 0\text{V}, V_{GS} = \pm 20\text{V}$ |      |      | $\pm 100$ | nA               |
| Gate Threshold Voltage            | $V_{GS(th)}$  | $V_{DS} = V_{GS}, I_D = 250\mu\text{A}$       | 2.2  | 2.8  | 3.4       | V                |
| Static Drain-Source ON-Resistance | $R_{DS(ON)}$  | $V_{GS} = 10\text{V}, I_D = 20\text{A}$       |      | 1.3  | 1.7       | $\text{m}\Omega$ |
| Forward Transconductance          | $g_{FS}$      | $V_{DS} = 5\text{V}, I_D = 20\text{A}$        |      | 90   |           | S                |
| Diode Forward Voltage             | $V_{SD}$      | $I_S = 1\text{A}, V_{GS} = 0\text{V}$         |      | 0.68 | 1.0       | V                |
| Diode Continuous Current          | $I_S$         | $T_C = 25^\circ\text{C}$                      |      |      | 136       | A                |

**DYNAMIC PARAMETERS** <sup>(5)</sup>

|                              |           |  |  |      |  |          |
|------------------------------|-----------|--|--|------|--|----------|
| Input Capacitance            | $C_{iss}$ | $V_{GS} = 0\text{V}, V_{DS} = 20\text{V}, f = 1\text{MHz}$ |  | 3015 |  | pF       |
| Output Capacitance           | $C_{oss}$ |  |  | 2000 |  | pF       |
| Reverse Transfer Capacitance | $C_{rss}$ |  |  | 18.0 |  | pF       |
| Gate Resistance              | $R_g$     | $V_{GS} = 0\text{V}, V_{DS} = 0\text{V}, f = 1\text{MHz}$  |  | 3.0  |  | $\Omega$ |

**SWITCHING PARAMETERS** <sup>(5)</sup>

|   |              |  |   |      |    |    |
|---|--------------|--|---|------|----|----|
| Total Gate Charge (@ $V_{GS} = 10\text{V}$ )  | $Q_g$        | $V_{GS} = 0 \text{ to } 10\text{V}$<br>$V_{DS} = 20\text{V}, I_D = 20\text{A}$     |   | 42   |    | nC |
| Total Gate Charge (@ $V_{GS} = 6.0\text{V}$ ) | $Q_g$        |  |   | 27   |    | nC |
| Gate Source Charge                            | $Q_{gs}$     |  |   | 12.8 |    | nC |
| Gate Drain Charge                             | $Q_{gd}$     |  |   | 8.0  |    | nC |
| Turn-On DelayTime                             | $t_{D(on)}$  | $V_{GS} = 10\text{V}, V_{DS} = 20\text{V}$<br>$R_L = 1.0\Omega, R_{GEN} = 6\Omega$ |   | 16.0 |    | ns |
| Turn-On Rise Time                             | $t_r$        |  |   | 20   |    | ns |
| Turn-Off DelayTime                            | $t_{D(off)}$ |  |   | 51   |    | ns |
| Turn-Off Fall Time                            | $t_f$        |  |   | 27   |    | ns |
| Body Diode Reverse Recovery Time              | $t_{rr}$     |  | $I_F = 20\text{A}, dI_F/dt = 100\text{A}/\mu\text{s}$ |      | 49 |    |
| Body Diode Reverse Recovery Charge            | $Q_{rr}$     | $I_F = 20\text{A}, dI_F/dt = 100\text{A}/\mu\text{s}$                              |   | 44   |    | nC |

**Thermal Performance**

| Parameter                               | Symbol          | Typ. | Max. | Unit                      |
|---|-----------------|------|------|---------------------------|
| Thermal Resistance, Junction-to-Ambient | $R_{\theta JA}$ | 48   | 57   | $^\circ\text{C}/\text{W}$ |
| Thermal Resistance, Junction-to-Case    | $R_{\theta JC}$ | 1.1  | 1.3  | $^\circ\text{C}/\text{W}$ |

**Notes:**

1. Computed continuous current assumes the condition of  $T_{J\_Max}$  while the actual continuous current depends on the thermal & electro-mechanical application board design.
2. This single-pulse measurement was taken under  $T_{J\_Max} = 175^\circ\text{C}$ .
3. This single-pulse measurement was taken under the following condition [ $L = 300\mu\text{H}, V_{GS} = 10\text{V}, V_{DS} = 20\text{V}$ ] while its value is limited by  $T_{J\_Max} = 175^\circ\text{C}$ .
4. The power dissipation  $P_D$  is based on  $T_{J\_Max} = 175^\circ\text{C}$ .
5. This value is guaranteed by design hence it is not included in the production test.

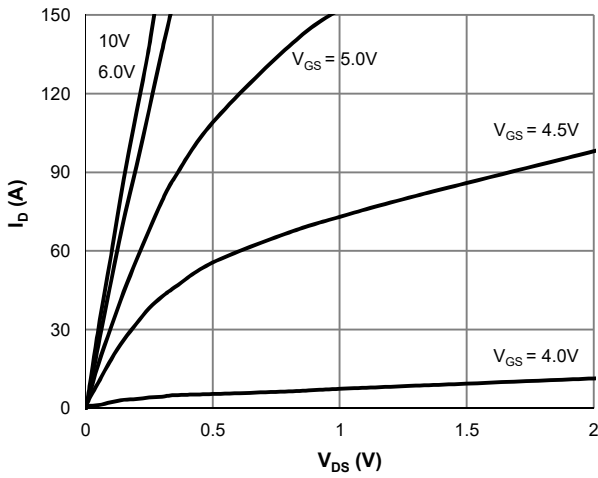
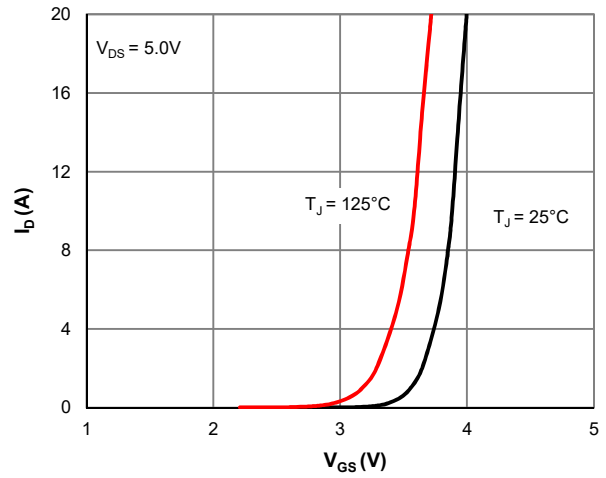
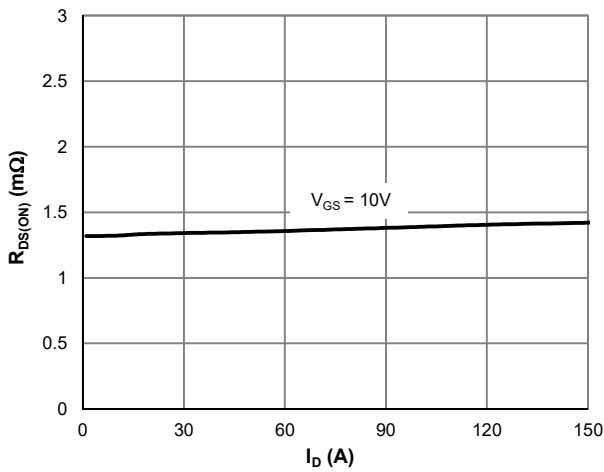
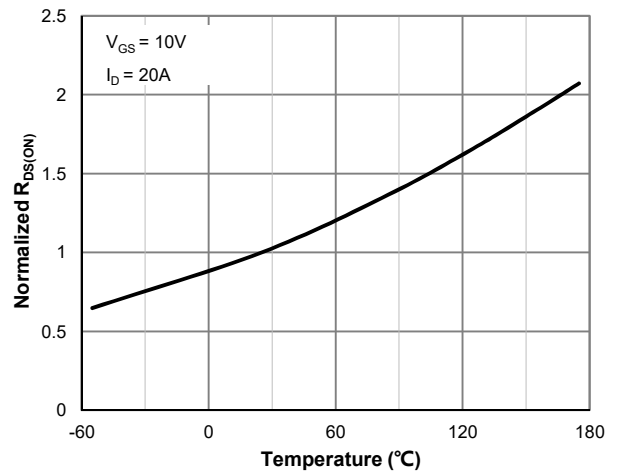
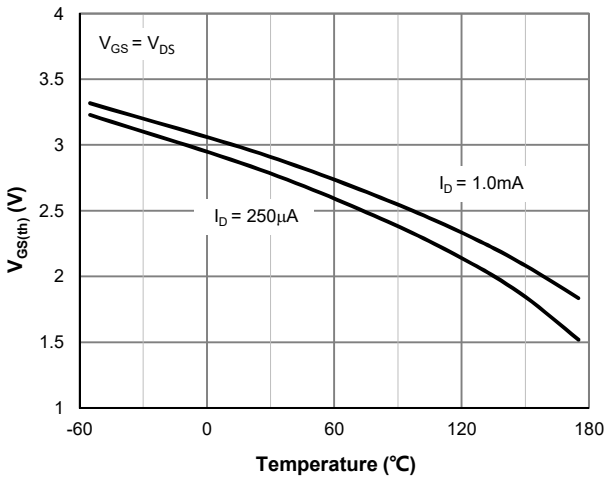
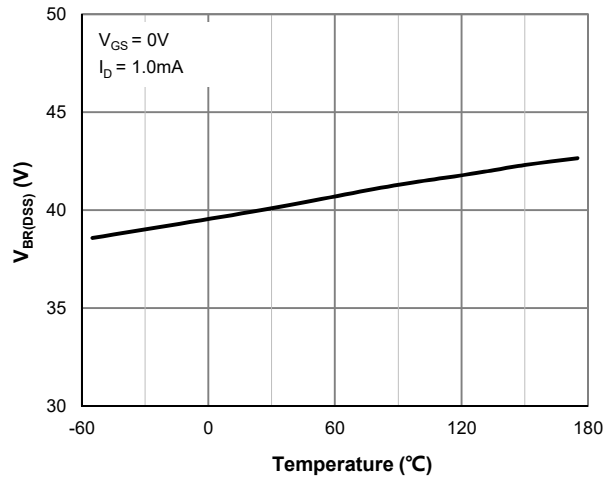
**Typical Electrical & Thermal Characteristics**

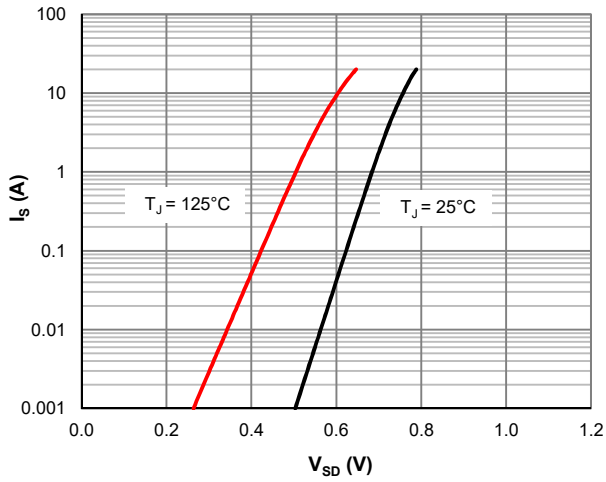
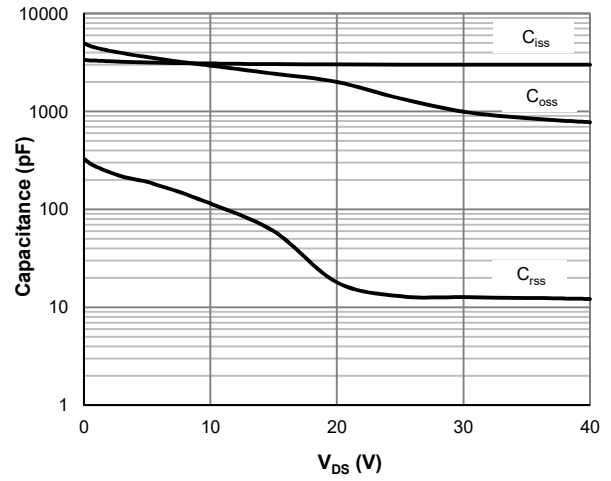
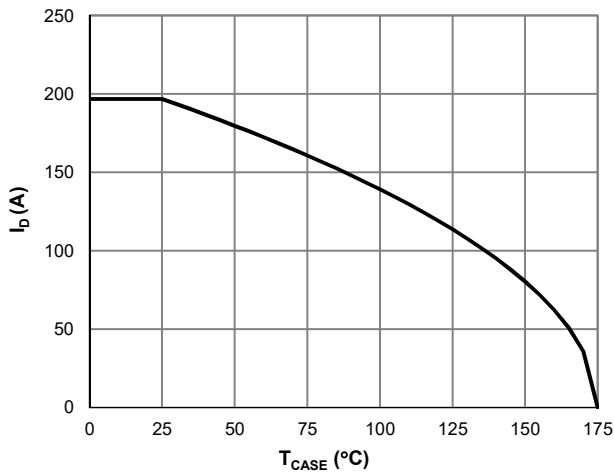
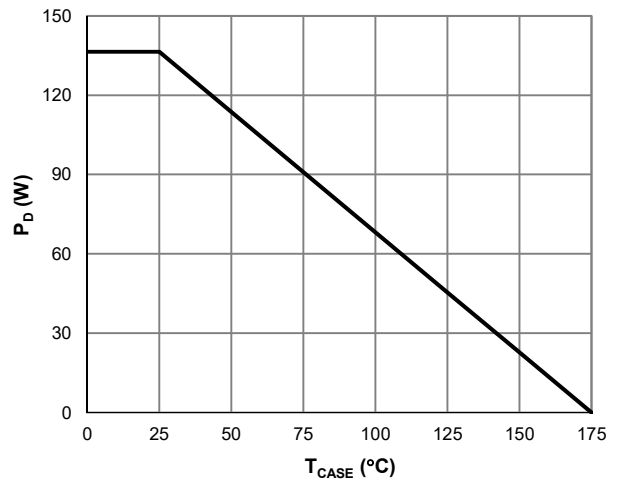
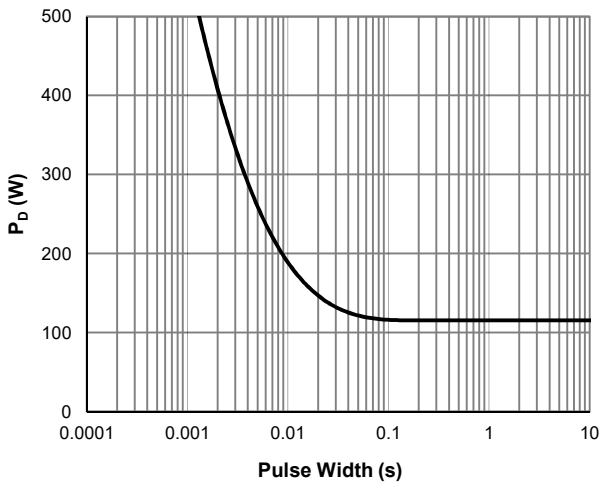
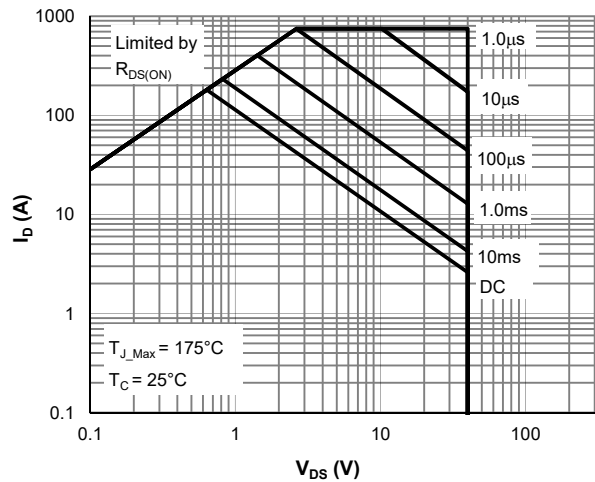
**Figure 1: Saturation Characteristics**

**Figure 2: Transfer Characteristics**

**Figure 3:  $R_{DS(ON)}$  vs. Drain Current**

**Figure 4:  $R_{DS(ON)}$  vs. Junction Temperature**

**Figure 5:  $V_{GS(th)}$  vs. Junction Temperature**

**Figure 6:  $V_{BR(DSS)}$  vs. Junction Temperature**

**Typical Electrical & Thermal Characteristics**

**Figure 7: Body-Diode Characteristics**

**Figure 8: Capacitance Characteristics**

**Figure 9: Current De-rating**

**Figure 10: Power De-rating**

**Figure 11: Single Pulse Power Rating, Junction-to-Case**

**Figure 12: Maximum Safe Operating Area**



### Typical Electrical & Thermal Characteristics

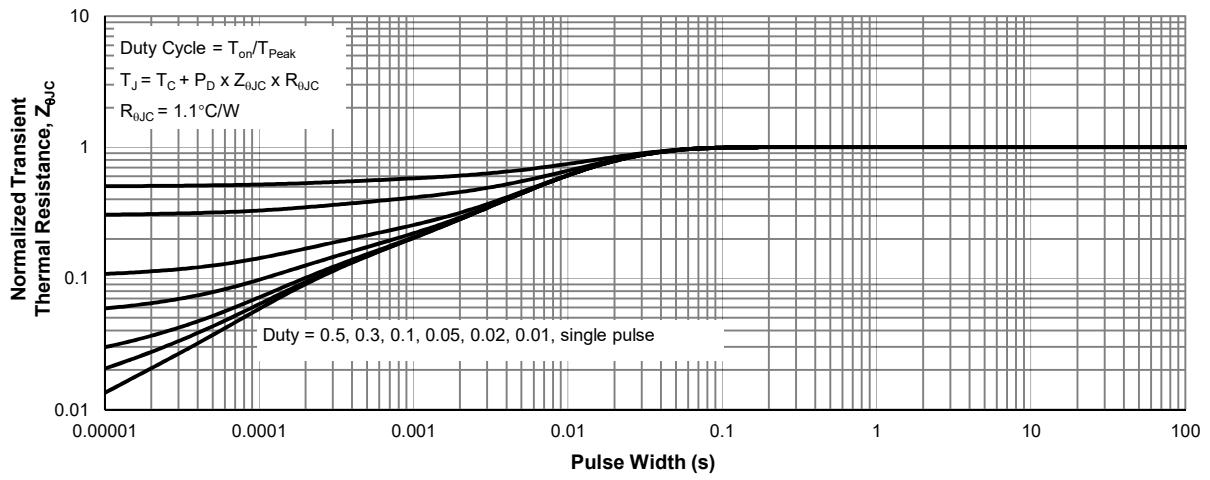
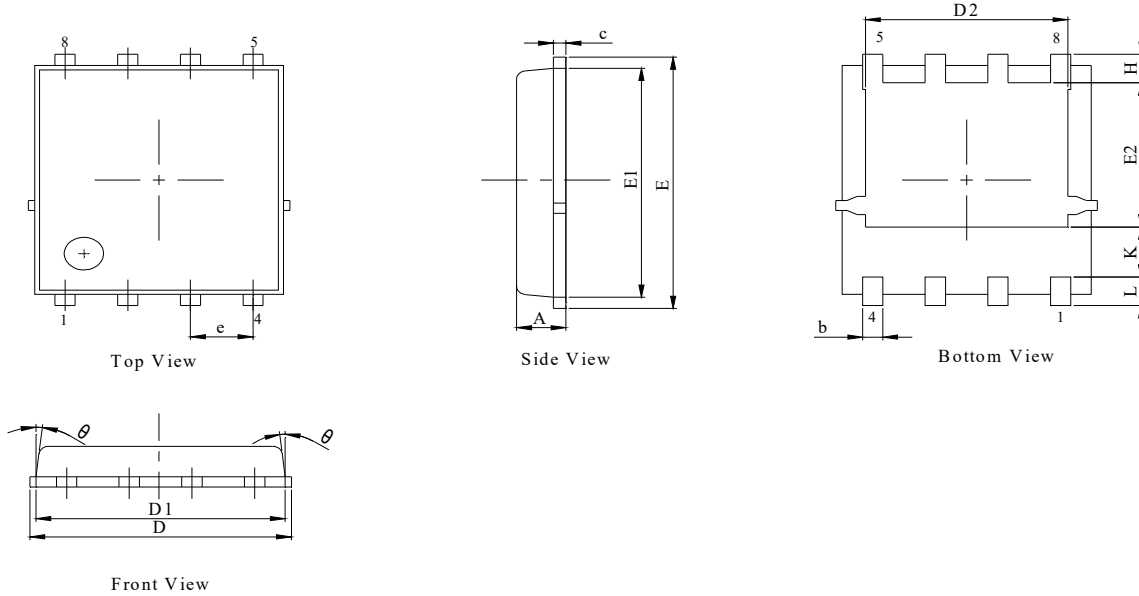
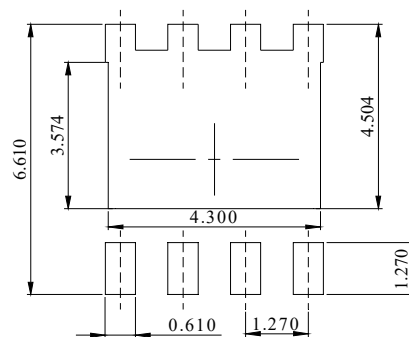

Figure 13: Normalized Maximum Transient Thermal Impedance

**PDFN5x6-8L Package Information**
**Package Outline**

**NOTES:**

1. Dimension and tolerance per ASME Y14.5M, 1994.
2. All dimensions in millimeter (angle in degree).
3. Dimensions D1 and E1 do not include mold flash protrusions or gate burrs.

| DIM.  | MILLIMETER |      |      |
|-------|------------|------|------|
|       | MIN.       | NOM. | MAX. |
| A     | 0.90       | 1.00 | 1.10 |
| b     | 0.31       | 0.41 | 0.51 |
| c     | 0.20       | 0.25 | 0.30 |
| D     | 5.00       | 5.20 | 5.40 |
| D1    | 4.95       | 5.05 | 5.15 |
| D2    | 4.00       | 4.10 | 4.20 |
| E     | 6.05       | 6.15 | 6.25 |
| E1    | 5.50       | 5.60 | 5.70 |
| E2    | 3.42       | 3.53 | 3.63 |
| e     | 1.27BSC    |      |      |
| H     | 0.60       | 0.70 | 0.80 |
| L     | 0.50       | 0.70 | 0.80 |
| K     | 1.23 REF   |      |      |
| theta | -          | -    | 10°  |

**Recommended Soldering Footprint**

DIMENSIONS: MILLIMETERS