



## 60V 1.3mΩ N-Ch Power MOSFET

### Features

- Ultra-low ON-resistance,  $R_{DS(ON)}$
- Low Gate Charge,  $Q_g$
- 100% UIS and  $R_g$  Tested
- Pb-free Lead Plating
- Halogen-free and RoHS-compliant
- AEC-Q101 Qualified for Automotive Applications

### Product Summary

Parameter	Value	Unit
$V_{DS}$	60	V
$V_{GS(th),Typ}$	2.8	V
$I_D$ (@ $V_{GS} = 10V$ ) <sup>(1)</sup>	225	A
$R_{DS(ON),Typ}$ (@ $V_{GS} = 10V$ )	1.3	mΩ

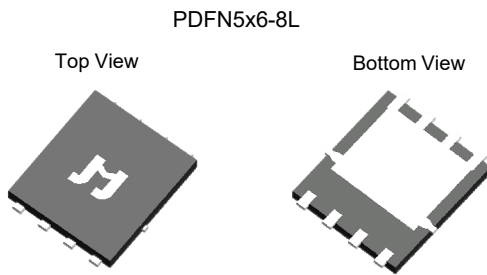

Pin Configuration  
Top View

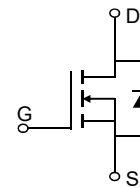
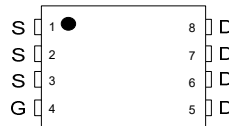

### Ordering Information

Device	Package	# of Pins	Marking	MSL	$T_J$ (°C)	Media	Quantity (pcs)
JMSH0601AGQ-13	PDFN5x6-8L	8	SH0601AQ	1	-55 to 175	13-inch Reel	3000

### Absolute Maximum Ratings (@ $T_A = 25^\circ\text{C}$ unless otherwise specified)

Parameter	Symbol	Value	Unit
Drain-to-Source Voltage	$V_{DS}$	60	V
Gate-to-Source Voltage	$V_{GS}$	$\pm 20$	V
Continuous Drain Current <sup>(1)</sup>	$I_D$	$T_C = 25^\circ\text{C}$	225
		$T_C = 100^\circ\text{C}$	159
Pulsed Drain Current <sup>(2)</sup>	$I_{DM}$	902	A
Avalanche Current <sup>(3)</sup>	$I_{AS}$	50	A
Avalanche Energy <sup>(3)</sup>	$E_{AS}$	375	mJ
Power Dissipation <sup>(4)</sup>	$P_D$	$T_C = 25^\circ\text{C}$	176
		$T_C = 100^\circ\text{C}$	88
Junction & Storage Temperature Range	$T_J, T_{STG}$	-55 to 175	°C

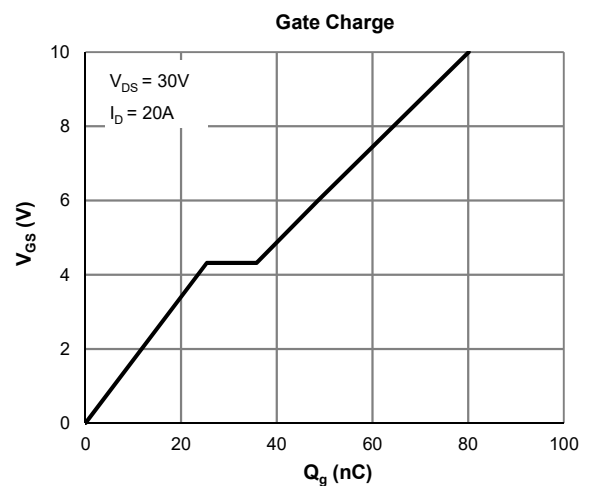
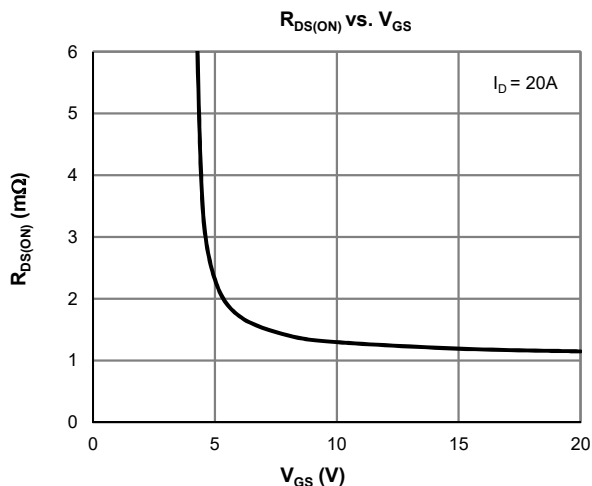



**Electrical Characteristics** (@  $T_J = 25^\circ\text{C}$  unless otherwise specified)

Parameter	Symbol	Conditions	Min.	Typ.	Max.	Unit
<b>STATIC PARAMETERS</b>						
Drain-Source Breakdown Voltage	$V_{(BR)DSS}$	$I_D = 250\mu\text{A}, V_{GS} = 0\text{V}$	60			V
Zero Gate Voltage Drain Current	$I_{DSS}$	$V_{DS} = 48\text{V}, V_{GS} = 0\text{V}$ $T_J = 55^\circ\text{C}$			1.0	$\mu\text{A}$
					5.0	
Gate-Body Leakage Current	$I_{GSS}$	$V_{DS} = 0\text{V}, V_{GS} = \pm 20\text{V}$			$\pm 100$	nA
Gate Threshold Voltage	$V_{GS(th)}$	$V_{DS} = V_{GS}, I_D = 250\mu\text{A}$	2.2	2.8	3.4	V
Static Drain-Source ON-Resistance	$R_{DS(ON)}$	$V_{GS} = 10\text{V}, I_D = 20\text{A}$		1.3	1.7	$\text{m}\Omega$
Forward Transconductance	$g_{FS}$	$V_{DS} = 5\text{V}, I_D = 20\text{A}$		435		S
Diode Forward Voltage	$V_{SD}$	$I_S = 1\text{A}, V_{GS} = 0\text{V}$		0.65	1.0	V
Diode Continuous Current	$I_S$	$T_C = 25^\circ\text{C}$			176	A

**DYNAMIC PARAMETERS** <sup>(5)</sup>

Input Capacitance	$C_{ISS}$	$V_{GS} = 0\text{V}, V_{DS} = 30\text{V}, f = 1\text{MHz}$		5874		pF
Output Capacitance	$C_{OSS}$			1375		pF
Reverse Transfer Capacitance	$C_{RSS}$			45		pF
Gate Resistance	$R_g$		$V_{GS} = 0\text{V}, V_{DS} = 0\text{V}, f = 1\text{MHz}$		2.0	

**SWITCHING PARAMETERS** <sup>(5)</sup>

Total Gate Charge (@ $V_{GS} = 10\text{V}$ )	$Q_g$	$V_{GS} = 0 \text{ to } 10\text{V}$ $V_{DS} = 30\text{V}, I_D = 20\text{A}$		81		nC
Total Gate Charge (@ $V_{GS} = 6.0\text{V}$ )	$Q_g$			49		nC
Gate Source Charge	$Q_{gs}$			25		nC
Gate Drain Charge	$Q_{gd}$			10.4		nC
Turn-On DelayTime	$t_{D(on)}$	$V_{GS} = 10\text{V}, V_{DS} = 30\text{V}$ $R_L = 1.5\Omega, R_{GEN} = 6\Omega$		17.7		ns
Turn-On Rise Time	$t_r$			37		ns
Turn-Off DelayTime	$t_{D(off)}$			74		ns
Turn-Off Fall Time	$t_f$			37		ns
Body Diode Reverse Recovery Time	$t_{rr}$		$I_F = 20\text{A}, dI_F/dt = 100\text{A}/\mu\text{s}$		63	
Body Diode Reverse Recovery Charge	$Q_{rr}$	$I_F = 20\text{A}, dI_F/dt = 100\text{A}/\mu\text{s}$		83		nC

**Thermal Performance**

Parameter	Symbol	Typ.	Max.	Unit
Thermal Resistance, Junction-to-Ambient	$R_{\theta JA}$	42	50	$^\circ\text{C}/\text{W}$
Thermal Resistance, Junction-to-Case	$R_{\theta JC}$	0.85	1.0	$^\circ\text{C}/\text{W}$

**Notes:**

1. Computed continuous current assumes the condition of  $T_{J\_Max}$  while the actual continuous current depends on the thermal & electro-mechanical application board design.
2. This single-pulse measurement was taken under  $T_{J\_Max} = 175^\circ\text{C}$ .
3. This single-pulse measurement was taken under the following condition [ $L = 300\mu\text{H}, V_{GS} = 10\text{V}, V_{DD} = 30\text{V}$ ] while its value is limited by  $T_{J\_Max} = 175^\circ\text{C}$ .
4. The power dissipation  $P_D$  is based on  $T_{J\_Max} = 175^\circ\text{C}$ .
5. This value is guaranteed by design hence it is not included in the production test.

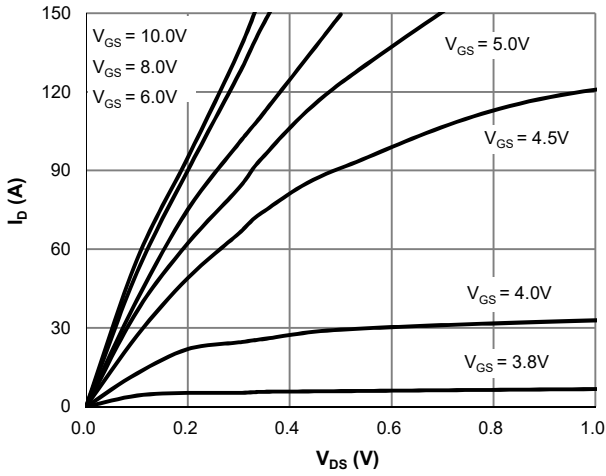
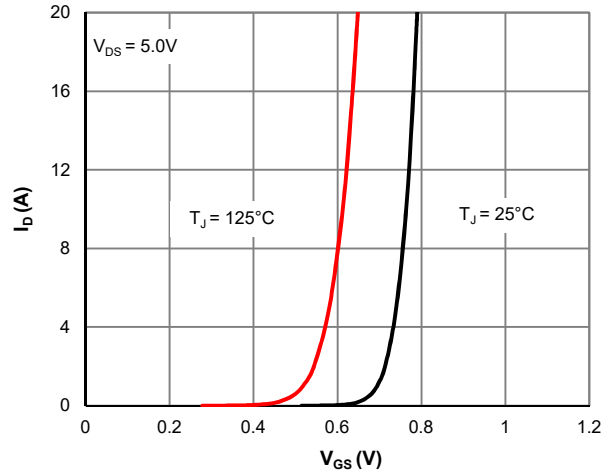
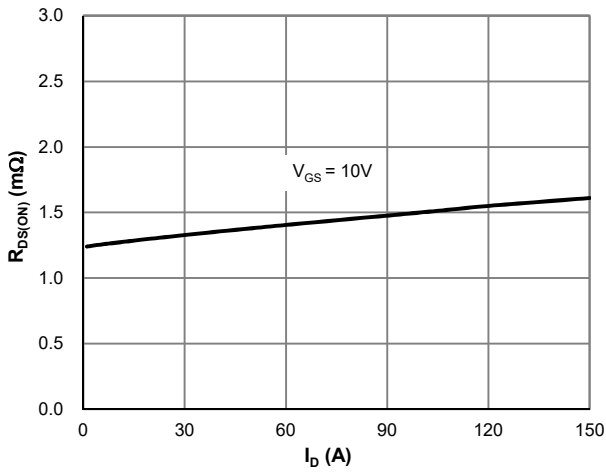
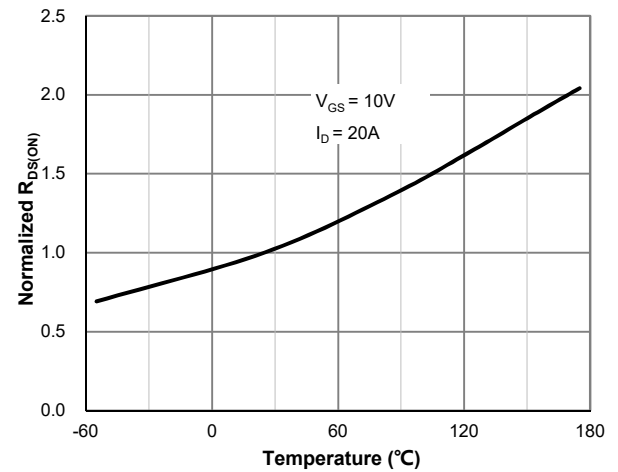
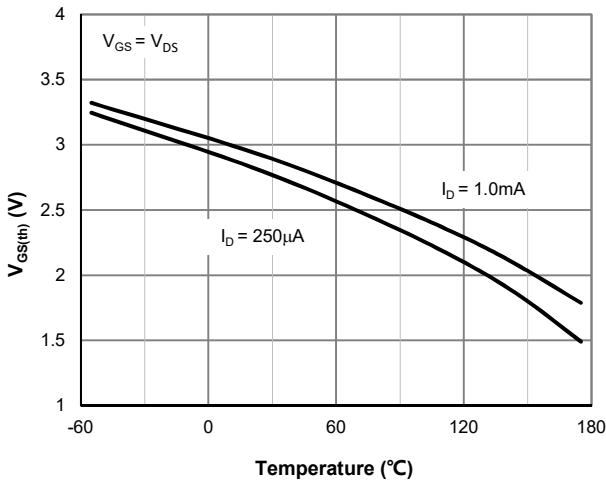
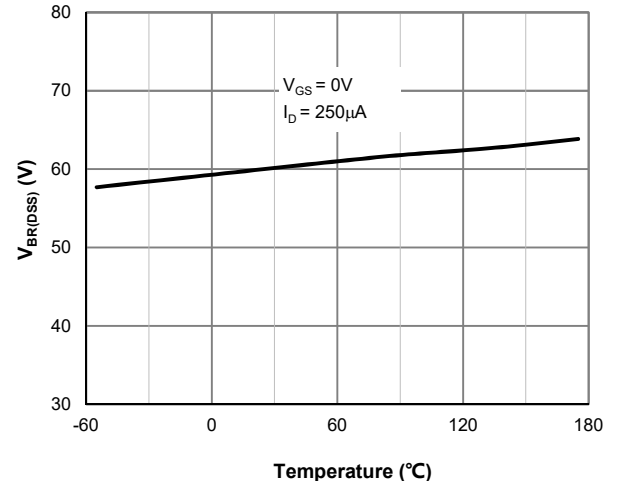
**Typical Electrical & Thermal Characteristics**

**Figure 1: Saturation Characteristics**

**Figure 2: Transfer Characteristics**

**Figure 3:  $R_{DS(ON)}$  vs. Drain Current**

**Figure 4:  $R_{DS(ON)}$  vs. Junction Temperature**

**Figure 5:  $V_{GS(th)}$  vs. Junction Temperature**

**Figure 6:  $V_{BR(DSS)}$  vs. Junction Temperature**

Typical Electrical & Thermal Characteristics

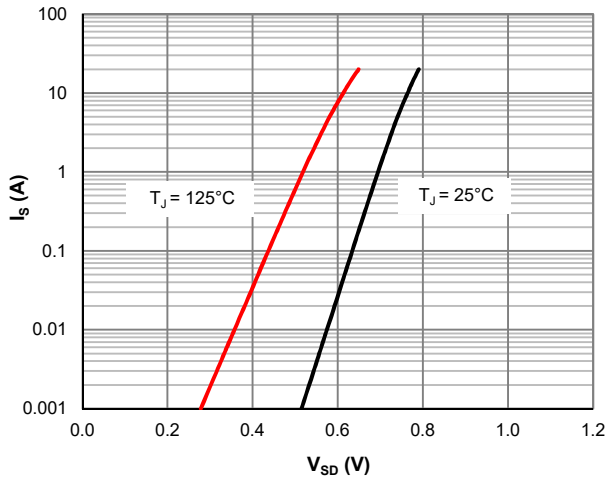

Figure 7: Body-Diode Characteristics

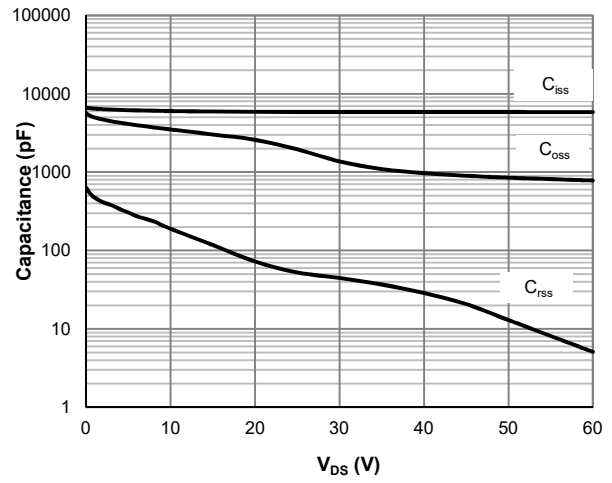

Figure 8: Capacitance Characteristics

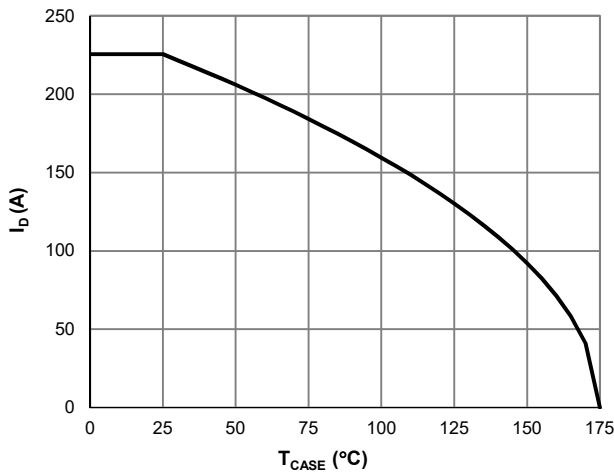

Figure 9: Current De-rating

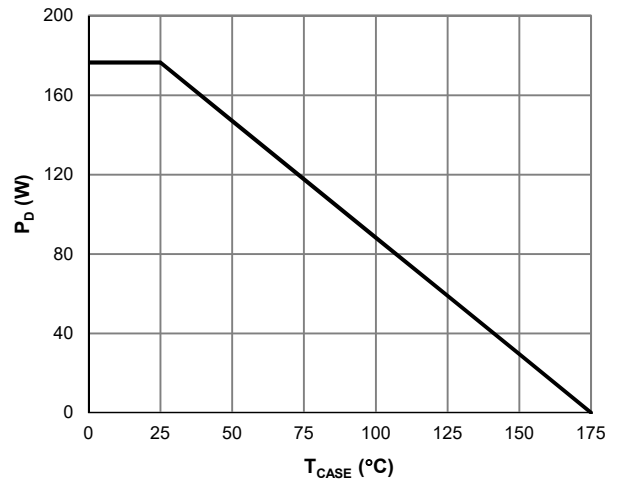

Figure 10: Power De-rating

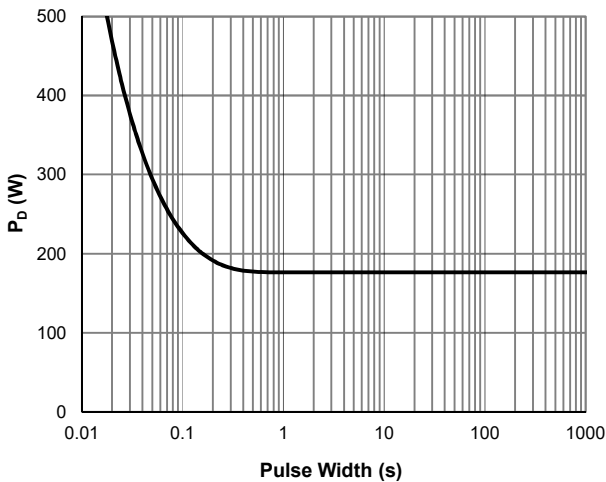

Figure 11: Single Pulse Power Rating, Junction-to-Case

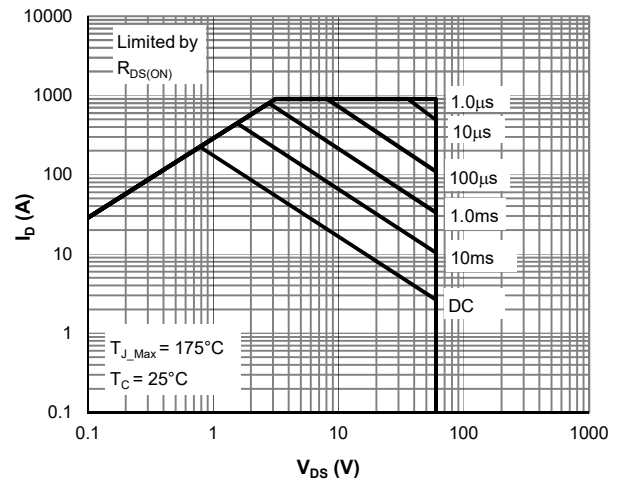

Figure 12: Maximum Safe Operating Area



### Typical Electrical & Thermal Characteristics

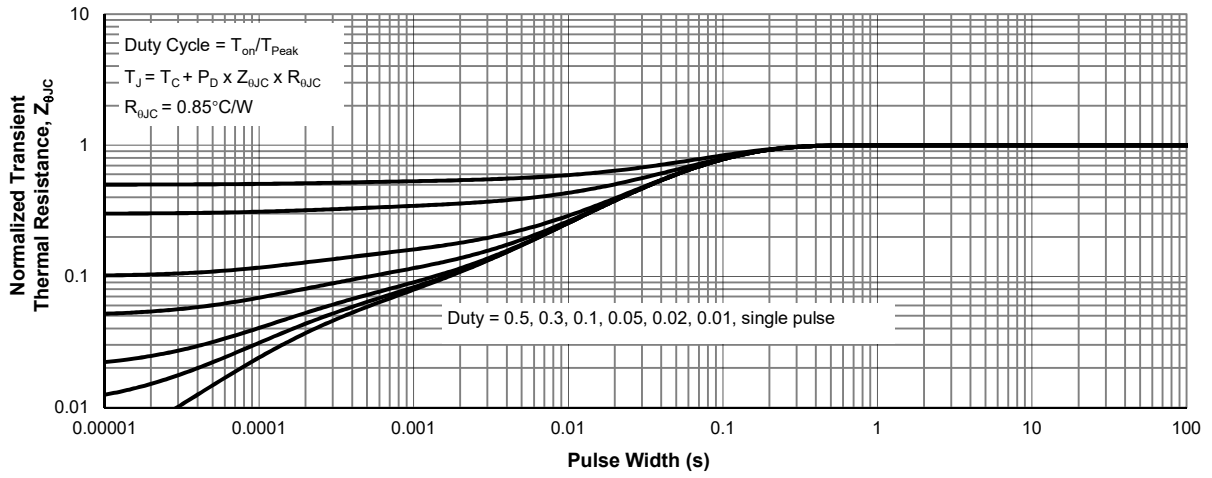
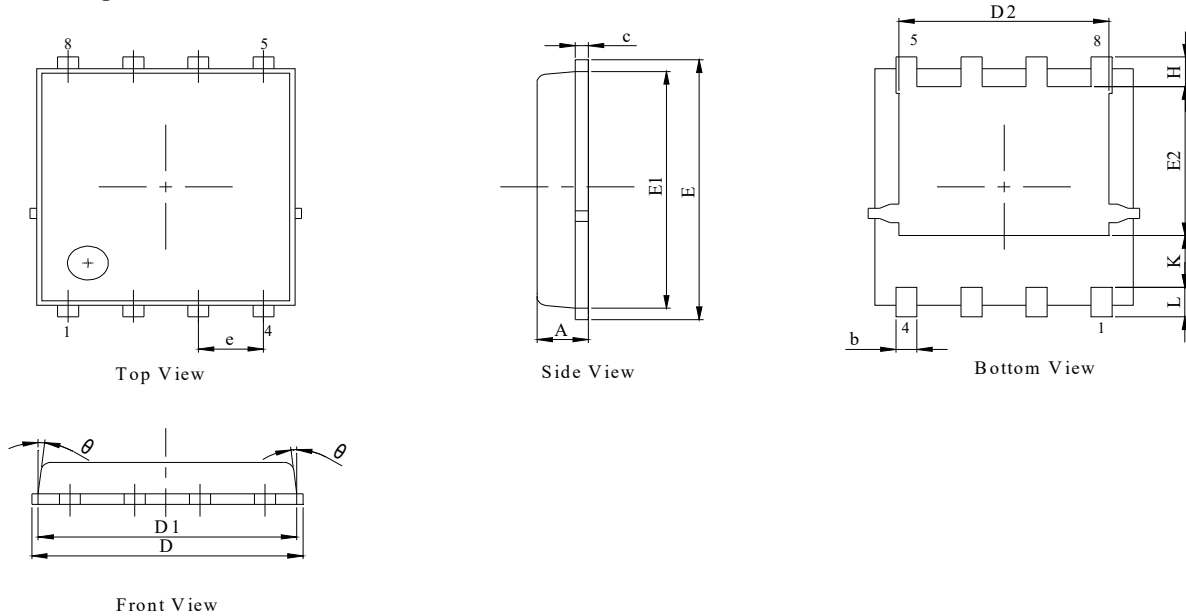
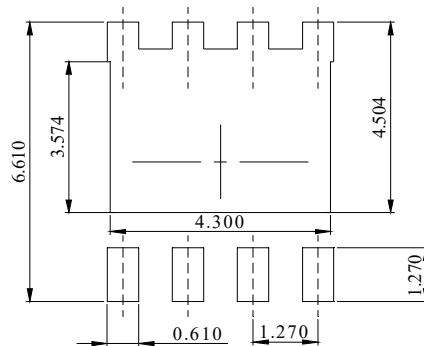

Figure 13: Normalized Maximum Transient Thermal Impedance

**PDFN5x6-8L Package Information**
**Package Outline**

**NOTES:**

1. Dimension and tolerance per ASME Y14.5M, 1994.
2. All dimensions in millimeter (angle in degree).
3. Dimensions D1 and E1 do not include mold flash protrusions or gate burrs.

DIM.	MILLIMETER		
	MIN.	NOM.	MAX.
A	0.90	1.00	1.10
b	0.31	0.41	0.51
c	0.20	0.25	0.30
D	5.00	5.20	5.40
D1	4.95	5.05	5.15
D2	4.00	4.10	4.20
E	6.05	6.15	6.25
E1	5.50	5.60	5.70
E2	3.42	3.53	3.63
e	1.27BSC		
H	0.60	0.70	0.80
L	0.50	0.70	0.80
K	1.23 REF		
θ	-	-	10°

**Recommended Soldering Footprint**

DIMENSIONS: MILLIMETERS