



100V 1.7mΩ N-Ch Power MOSFET

Features

- Ultra-low ON-resistance, $R_{DS(ON)}$
- Low Gate Charge, Q_g
- 100% UIS and R_g Tested
- Pb-free Lead Plating
- Halogen-free and RoHS-compliant

Product Summary

Parameter	Value	Unit
V_{DS}	100	V
$V_{GS(th_Typ)}$	2.8	V
I_D (@ $V_{GS} = 10V$) ⁽¹⁾	287	A
$R_{DS(ON_Typ)}$ (@ $V_{GS} = 10V$)	1.9	mΩ

Applications

- Power Management in Telecom., Industrial Automation, CE
- Motor Driving in Power Tool, E-vehicle, Robotics
- Current Switching in DC/DC & AC/DC Sub-systems

TO-247PS-3L Top View

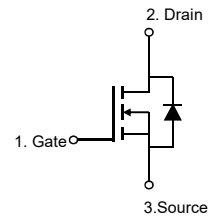
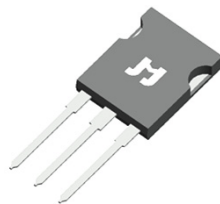

Ordering Information

Device	Package	# of Pins	Marking	MSL	T_J (°C)	Media	Quantity (pcs)
JMSH1002APS-U	TO-247PS-3L	3	SH1002A	N/A	-55 to 175	Tube	30

Absolute Maximum Ratings (@ $T_A = 25^\circ C$ unless otherwise specified)

Parameter	Symbol	Value	Unit
Drain-to-Source Voltage	V_{DS}	100	V
Gate-to-Source Voltage	V_{GS}	±20	V
Continuous Drain Current ⁽¹⁾	I_D	$T_C = 25^\circ C$	287
		$T_C = 100^\circ C$	203
Pulsed Drain Current ⁽²⁾	I_{DM}	960	A
Avalanche Current ⁽³⁾	I_{AS}	126	A
Avalanche Energy ⁽³⁾	E_{AS}	794	mJ
Power Dissipation ⁽⁴⁾	P_D	$T_C = 25^\circ C$	366
		$T_C = 100^\circ C$	183
Junction & Storage Temperature Range	T_J, T_{STG}	-55 to 175	°C

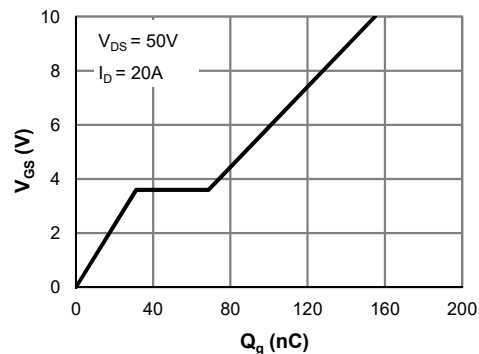
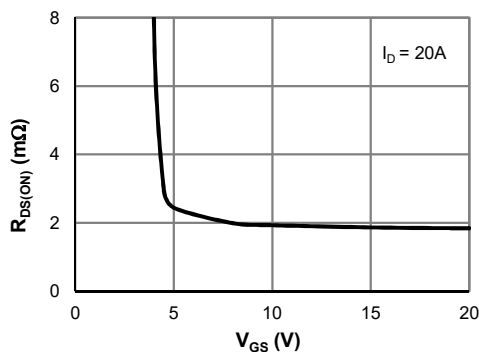

**Electrical Characteristics** (@ $T_J = 25^\circ\text{C}$ unless otherwise specified)

Parameter	Symbol	Conditions	Min.	Typ.	Max.	Unit
STATIC PARAMETERS						
Drain-Source Breakdown Voltage	$V_{(BR)DSS}$	$I_D = 250\mu\text{A}$, $V_{GS} = 0\text{V}$	100			V
Zero Gate Voltage Drain Current	I_{DSS}	$V_{DS} = 80\text{V}$, $V_{GS} = 0\text{V}$ $T_J = 55^\circ\text{C}$			1.0 5.0	μA
Gate-Body Leakage Current	I_{GSS}	$V_{DS} = 0\text{V}$, $V_{GS} = \pm 20\text{V}$			± 100	nA
Gate Threshold Voltage	$V_{GS(th)}$	$V_{DS} = V_{GS}$, $I_D = 250\mu\text{A}$	2.0	2.8	4.0	V
Static Drain-Source ON-Resistance	$R_{DS(ON)}$	$V_{GS} = 10\text{V}$, $I_D = 20\text{A}$		1.9	2.4	m Ω
Forward Transconductance	g_{FS}	$V_{DS} = 5\text{V}$, $I_D = 20\text{A}$		94		S
Diode Forward Voltage	V_{SD}	$I_S = 1\text{A}$, $V_{GS} = 0\text{V}$		0.7	1.0	V
Diode Continuous Current	I_S	$T_C = 25^\circ\text{C}$			366	A
DYNAMIC PARAMETERS ⁽⁵⁾						
Input Capacitance	C_{iss}	$V_{GS} = 0\text{V}$, $V_{DS} = 50\text{V}$, $f = 1\text{MHz}$		9674		pF
Output Capacitance	C_{oss}			2257		pF
Reverse Transfer Capacitance	C_{rss}			32		pF
Gate Resistance	R_g	$V_{GS} = 0\text{V}$, $V_{DS} = 0\text{V}$, $f = 1\text{MHz}$		2.4		Ω
SWITCHING PARAMETERS ⁽⁵⁾						
Total Gate Charge (@ $V_{GS} = 10\text{V}$)	Q_g	$V_{GS} = 0$ to 10V $V_{DS} = 50\text{V}$, $I_D = 20\text{A}$		155		nC
Total Gate Charge (@ $V_{GS} = 6.0\text{V}$)	Q_g			101		nC
Gate Source Charge	Q_{gs}			31		nC
Gate Drain Charge	Q_{gd}			37		nC
Turn-On DelayTime	$t_{D(on)}$	$V_{GS} = 10\text{V}$, $V_{DS} = 50\text{V}$ $R_L = 2.5\Omega$, $R_{GEN} = 6\Omega$		34		ns
Turn-On Rise Time	t_r			67		ns
Turn-Off DelayTime	$t_{D(off)}$			145		ns
Turn-Off Fall Time	t_f			111		ns
Body Diode Reverse Recovery Time	t_{rr}		$I_F = 15\text{A}$, $dI_F/dt = 100\text{A}/\mu\text{s}$		76	
Body Diode Reverse Recovery Charge	Q_{rr}	$I_F = 15\text{A}$, $dI_F/dt = 100\text{A}/\mu\text{s}$		116		nC

Thermal Performance

Parameter	Symbol	Typ.	Max.	Unit
Thermal Resistance, Junction-to-Ambient	$R_{\theta JA}$	48	58	$^\circ\text{C}/\text{W}$
Thermal Resistance, Junction-to-Case	$R_{\theta JC}$	0.34	0.41	$^\circ\text{C}/\text{W}$

Notes:

1. Computed continuous current assumes the condition of T_{J_Max} while the actual continuous current depends on the thermal & electro-mechanical application board design.
2. This single-pulse measurement was taken under $T_{J_Max} = 175^\circ\text{C}$.
3. This single-pulse measurement was taken under the following condition [$L = 100\mu\text{H}$, $V_{GS} = 10\text{V}$, $V_{DS} = 50\text{V}$] while its value is limited by $T_{J_Max} = 175^\circ\text{C}$.
4. The power dissipation P_D is based on $T_{J_Max} = 175^\circ\text{C}$.
5. This value is guaranteed by design hence it is not included in the production test.
6. Continuous current rating is limited by the package used.

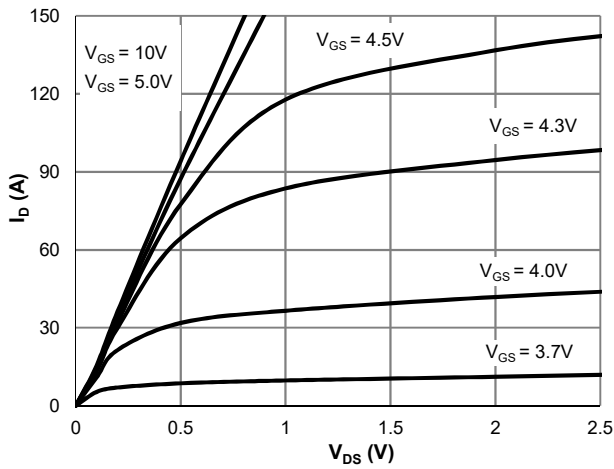
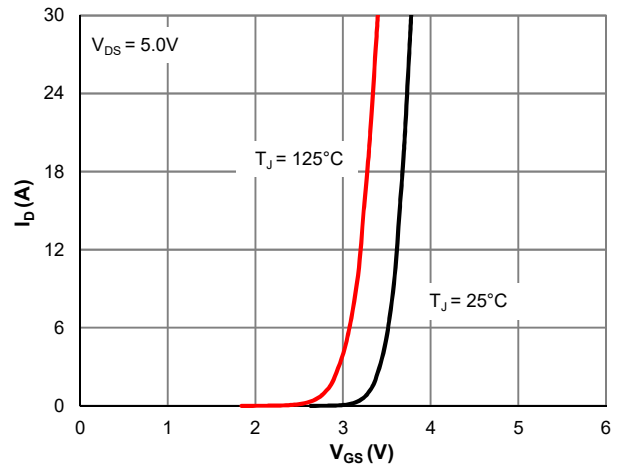
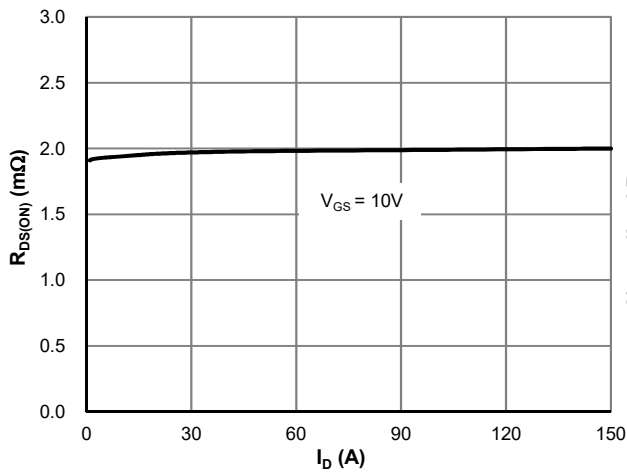
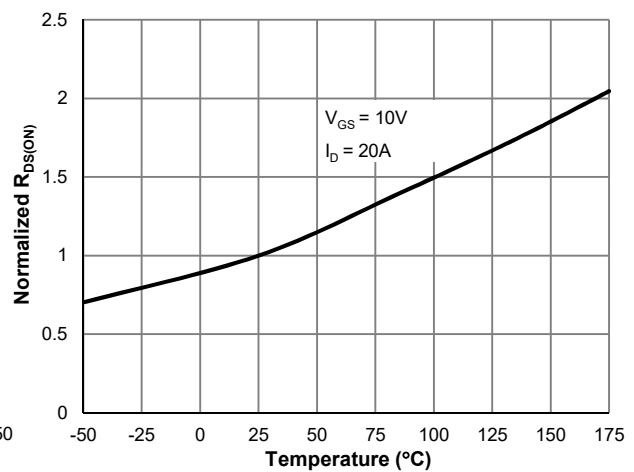
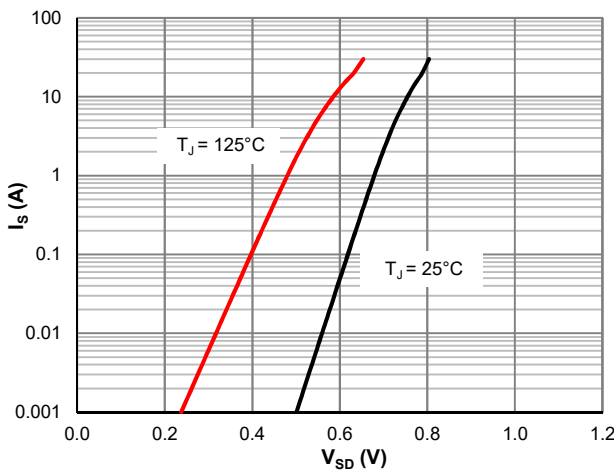
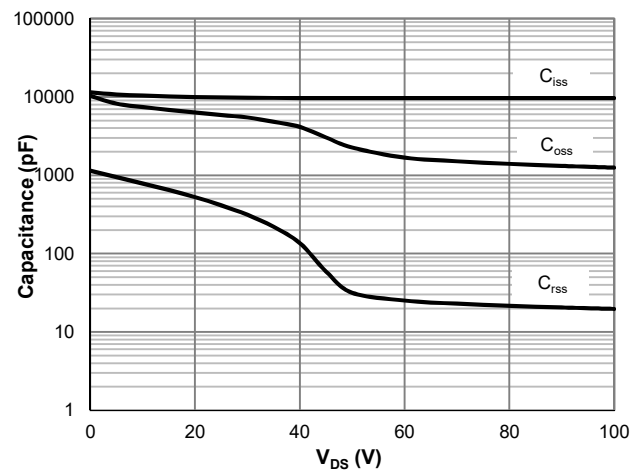
Typical Electrical & Thermal Characteristics

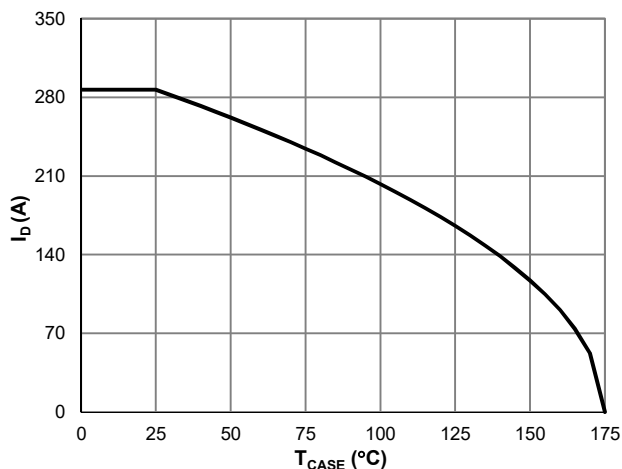
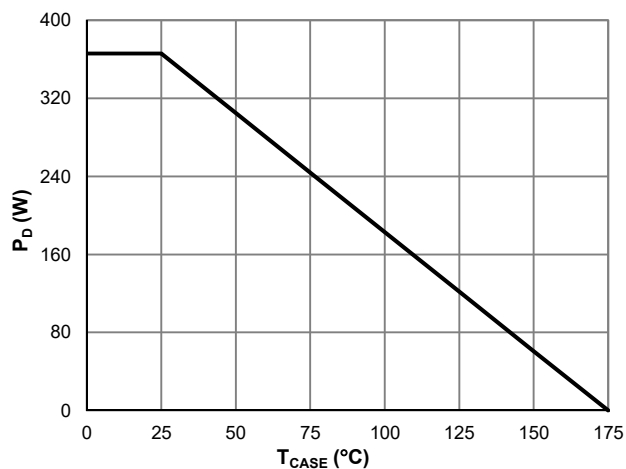
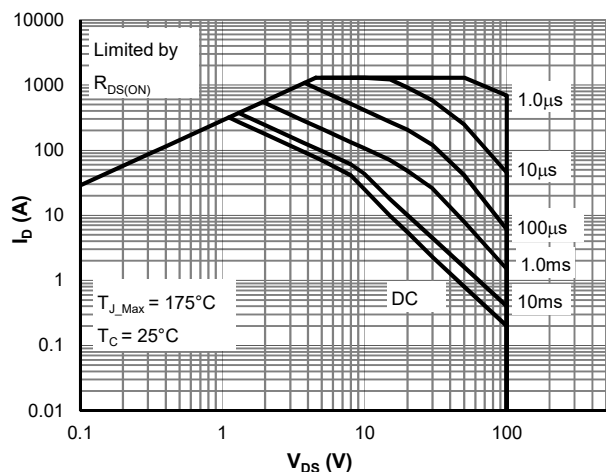
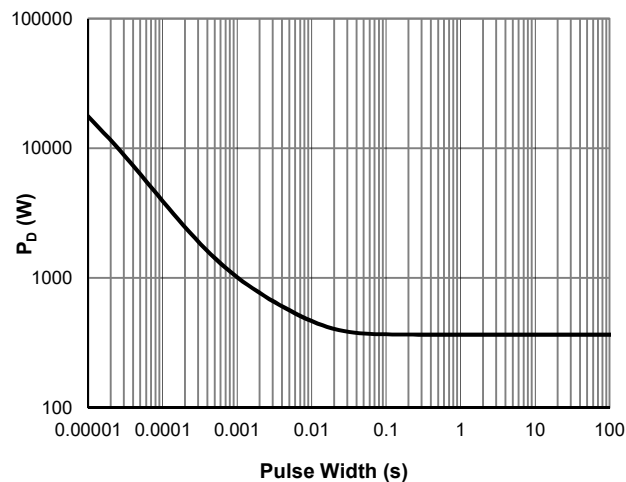
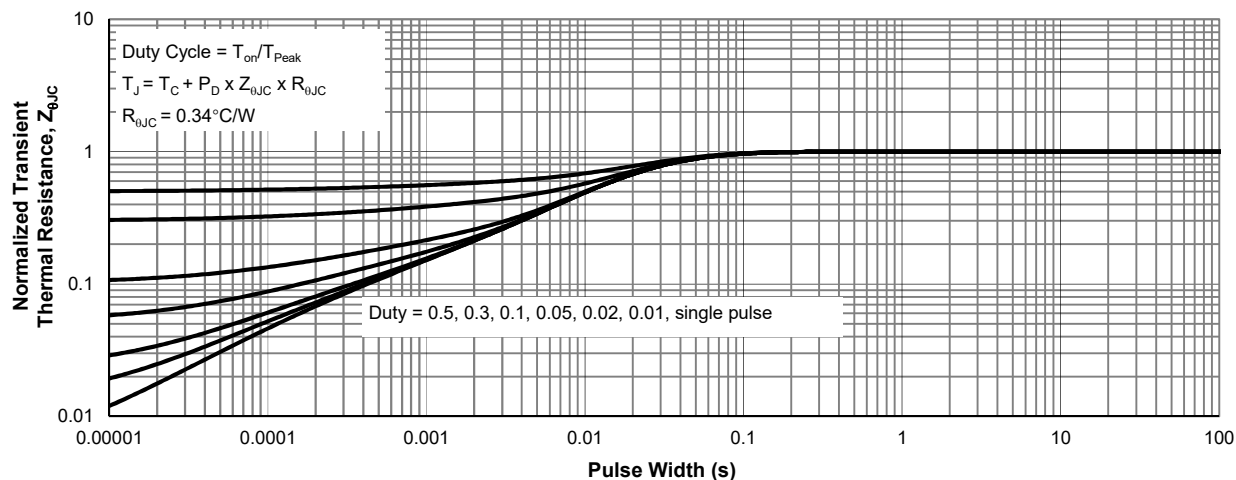
Figure 1: Saturation Characteristics

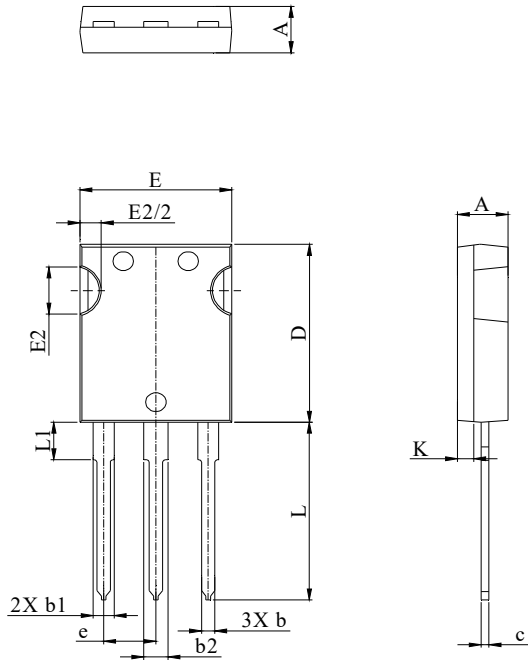
Figure 2: Transfer Characteristics

Figure 3: $R_{DS(ON)}$ vs. Drain Current

Figure 4: $R_{DS(ON)}$ vs. Junction Temperature

Figure 5: Body-Diode Characteristics

Figure 6: Capacitance Characteristics

Typical Electrical & Thermal Characteristics

Figure 7: Current De-rating

Figure 8: Power De-rating

Figure 9: Maximum Safe Operating Area

Figure 10: Single Pulse Power Rating, Junction-to-Case

Figure 11: Normalized Maximum Transient Thermal Impedance

TO-247PS-3L Package Information
Package Outline

DIM.	MILLIMETER		
	MIN.	NOM.	MAX.
A	4.80	5.00	5.20
b	1.10	1.20	1.30
b1	1.90	2.00	2.10
b2	2.90	3.00	3.10
c	0.50	0.60	0.70
D	20.80	21.00	21.20
E	15.60	15.80	16.00
E2	2.50	--	3.80
L	19.70	19.9	20.10
L1	--	--	4.40
K	1.90	--	2.10
Q	5.90	6.10	6.30
e	5.44 BSC		