



**100V 2.4mΩ N-Ch Power MOSFET**

**Features**

- Ultra-low  $R_{DS(ON)}$
- Low Gate Charge
- High Current Capability
- 100% UIS Tested, 100%  $R_g$  Tested

**Product Summary**

Parameter	Value	Unit
$V_{DS}$	100	V
$V_{GS(th)_Typ}$	2.8	V
$I_D$ (@ $V_{GS} = 10V$ ) <sup>(1)</sup>	219	A
$R_{DS(ON)_Typ}$ (@ $V_{GS} = 10V$ )	2.4	mΩ

**Applications**

- Power Management in Telecom., Industrial Automation, CE
- Current Switching in DC/DC & AC/DC (SR) Sub-systems
- Motor Driving in Power Tool, E-vehicle, Robotics

TO-220-3L Top View

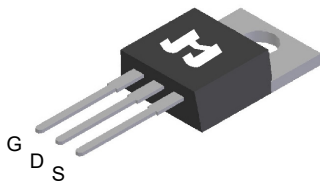

TO-263-3L Top View

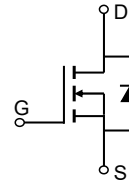
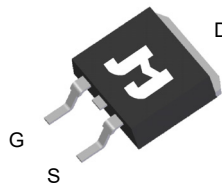

**Ordering Information**

Device	Package	# of Pins	Marking	MSL	$T_J$ (°C)	Media	Quantity (pcs)
JMSH1002CC-U	TO-220-3L	3	SH1002C	N/A	-55 to 150	Tube	50
JMSH1002CE-13	TO-263-3L	3	SH1002C	1	-55 to 150	13-inch Reel	800

**Absolute Maximum Ratings** (@  $T_A = 25^\circ C$  unless otherwise specified)

Parameter	Symbol	Value	Unit
Drain-to-Source Voltage	$V_{DS}$	100	V
Gate-to-Source Voltage	$V_{GS}$	$\pm 20$	V
Continuous Drain Current <sup>(1)</sup>	$I_D$	$T_C = 25^\circ C$	219
		$T_C = 100^\circ C$	139
Continuous Drain Current <sup>(6)</sup>	$I_D$	180	A
Pulsed Drain Current <sup>(2)</sup>	$I_{DM}$	878	A
Avalanche Current <sup>(3)</sup>	$I_{AS}$	61	A
Avalanche Energy <sup>(3)</sup>	$E_{AS}$	558	mJ
Power Dissipation <sup>(4)</sup>	$P_D$	$T_C = 25^\circ C$	250
		$T_C = 100^\circ C$	100
Junction & Storage Temperature Range	$T_J, T_{STG}$	-55 to 150	°C

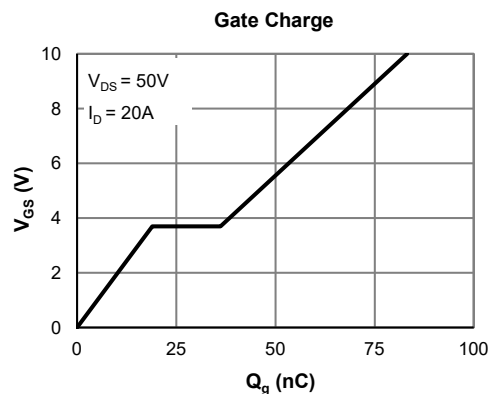
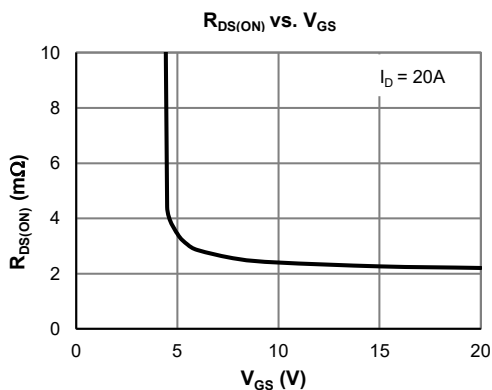



**Electrical Characteristics** (@  $T_J = 25^\circ\text{C}$  unless otherwise specified)

Parameter	Symbol	Conditions	Min.	Typ.	Max.	Unit
<b>STATIC PARAMETERS</b>						
Drain-Source Breakdown Voltage	$V_{(BR)DSS}$	$I_D = 250\mu\text{A}, V_{GS} = 0\text{V}$	100			V
Zero Gate Voltage Drain Current	$I_{DSS}$	$V_{DS} = 80\text{V}, V_{GS} = 0\text{V}$			1.0	$\mu\text{A}$
					5.0	
Gate-Body Leakage Current	$I_{GSS}$	$V_{DS} = 0\text{V}, V_{GS} = \pm 20\text{V}$			$\pm 100$	nA
Gate Threshold Voltage	$V_{GS(th)}$	$V_{DS} = V_{GS}, I_D = 250\mu\text{A}$	2.0	2.8	4.0	V
Static Drain-Source ON-Resistance	$R_{DS(ON)}$	$V_{GS} = 10\text{V}, I_D = 20\text{A}$		2.4	2.9	$\text{m}\Omega$
Static Drain-Source ON-Resistance	$R_{DS(ON)}$	$V_{GS} = 10\text{V}, I_D = 20\text{A}$		2.6	3.1	$\text{m}\Omega$
Forward Transconductance	$g_{FS}$	$V_{DS} = 5\text{V}, I_D = 20\text{A}$		51		S
Diode Forward Voltage	$V_{SD}$	$I_S = 1\text{A}, V_{GS} = 0\text{V}$		0.70	1.0	V
Diode Continuous Current	$I_S$	$T_C = 25^\circ\text{C}$			250	A

**DYNAMIC PARAMETERS** <sup>(5)</sup>

Input Capacitance	$C_{iss}$	$V_{GS} = 0\text{V}, V_{DS} = 50\text{V}, f = 1\text{MHz}$		5740		pF
Output Capacitance	$C_{oss}$			1193		pF
Reverse Transfer Capacitance	$C_{rss}$			7.6		pF
Gate Resistance	$R_g$	$V_{GS} = 0\text{V}, V_{DS} = 0\text{V}, f = 1\text{MHz}$		1.1		$\Omega$

**SWITCHING PARAMETERS** <sup>(5)</sup>

Total Gate Charge (@ $V_{GS} = 10\text{V}$ )	$Q_g$	$V_{GS} = 0 \text{ to } 10\text{V}$ $V_{DS} = 50\text{V}, I_D = 20\text{A}$		83		nC
Total Gate Charge (@ $V_{GS} = 6.0\text{V}$ )	$Q_g$			53		nC
Gate Source Charge	$Q_{gs}$			19.0		nC
Gate Drain Charge	$Q_{gd}$			17.2		nC
Turn-On Delay Time	$t_{D(on)}$	$V_{GS} = 10\text{V}, V_{DS} = 50\text{V}$ $R_L = 2.5\Omega, R_{GEN} = 6\Omega$		23		ns
Turn-On Rise Time	$t_r$			38		ns
Turn-Off Delay Time	$t_{D(off)}$			72		ns
Turn-Off Fall Time	$t_f$			53		ns
Body Diode Reverse Recovery Time	$t_{rr}$		$I_F = 15\text{A}, dI_F/dt = 100\text{A}/\mu\text{s}$		73	
Body Diode Reverse Recovery Charge	$Q_{rr}$	$I_F = 15\text{A}, dI_F/dt = 100\text{A}/\mu\text{s}$		83		nC

**Thermal Performance**

Parameter	Symbol	Typ.	Max.	Unit
Thermal Resistance, Junction-to-Ambient	$R_{\theta JA}$	54	65	$^\circ\text{C}/\text{W}$
Thermal Resistance, Junction-to-Case	$R_{\theta JC}$	0.38	0.50	$^\circ\text{C}/\text{W}$

**Notes:**

1. Computed continuous current assumes the condition of  $T_{J\_Max}$  while the actual continuous current depends on the thermal & electro-mechanical application board design.
2. This single-pulse measurement was taken under  $T_{J\_Max} = 150^\circ\text{C}$ .
3. This single-pulse measurement was taken under the following condition [L = 300mH,  $V_{GS} = 10\text{V}, V_{DS} = 50\text{V}$ ] while its value is limited by  $T_{J\_Max} = 150^\circ\text{C}$ .
4. The power dissipation  $P_D$  is based on  $T_{J\_Max} = 150^\circ\text{C}$ .
5. This value is guaranteed by design hence it is not included in the production test.
6. Continuous current rating is limited by the package used.



### Typical Electrical & Thermal Characteristics

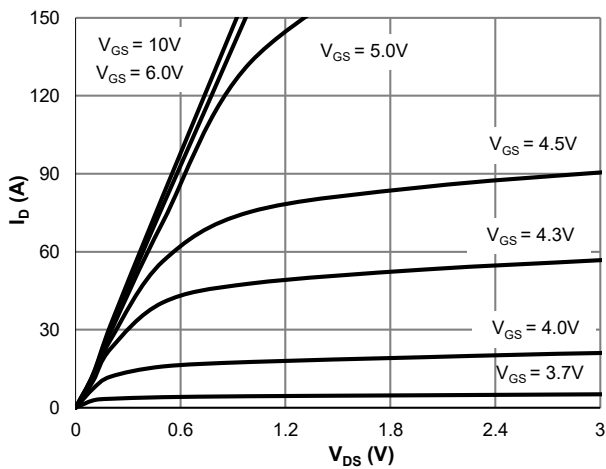

Figure 1: Saturation Characteristics

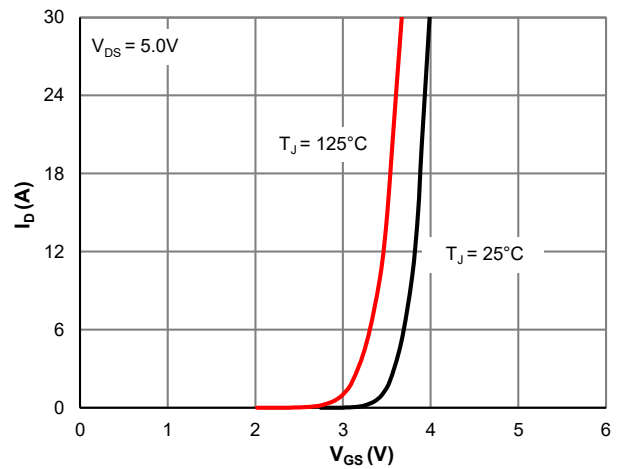

Figure 2: Transfer Characteristics

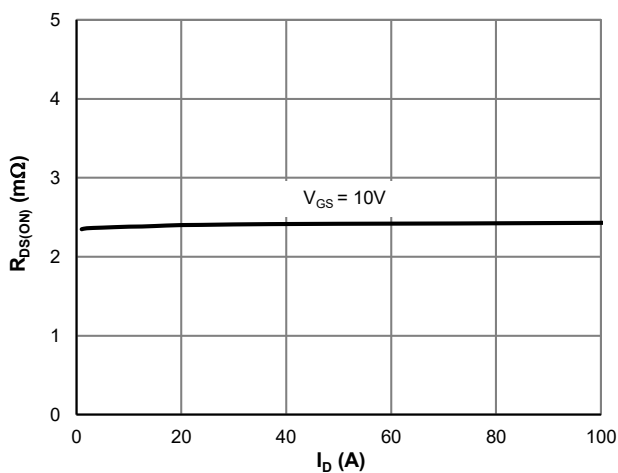

Figure 3:  $R_{DS(ON)}$  vs. Drain Current

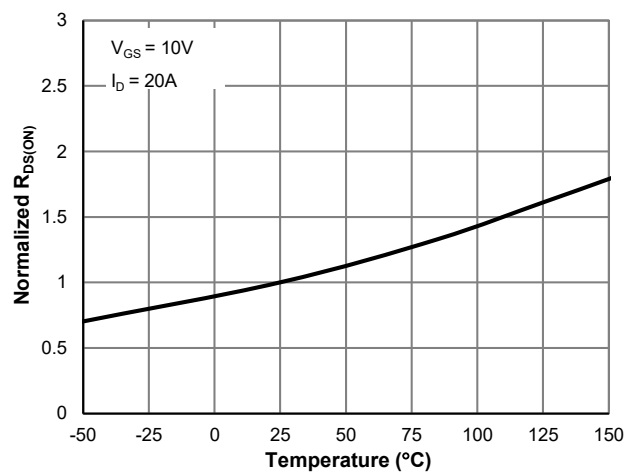

Figure 4:  $R_{DS(ON)}$  vs. Junction Temperature

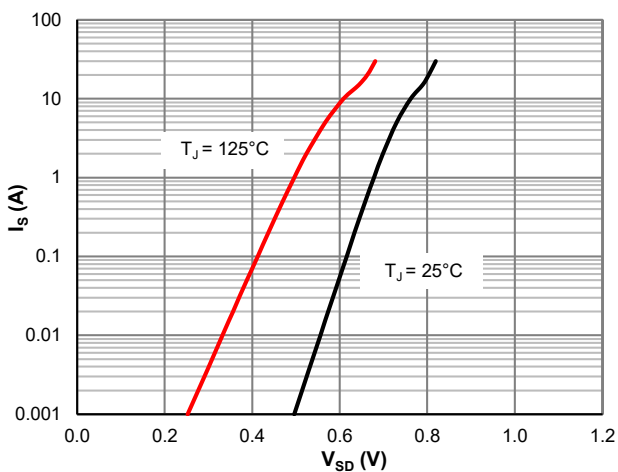

Figure 5: Body-Diode Characteristics

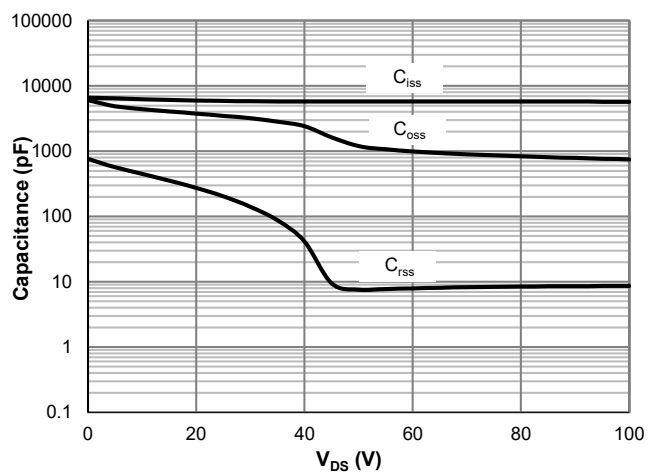

Figure 6: Capacitance Characteristics

Typical Electrical & Thermal Characteristics

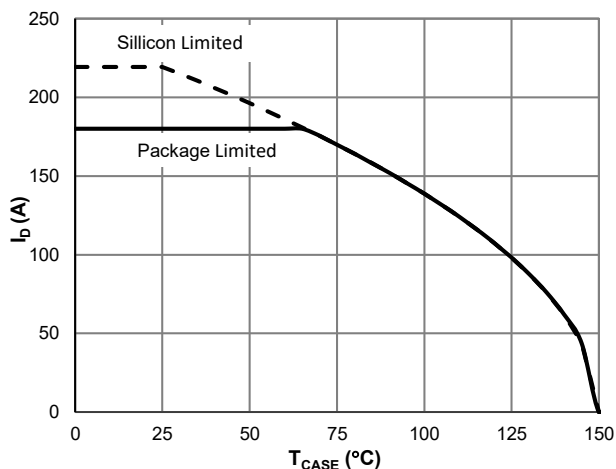

Figure 7: Current De-rating

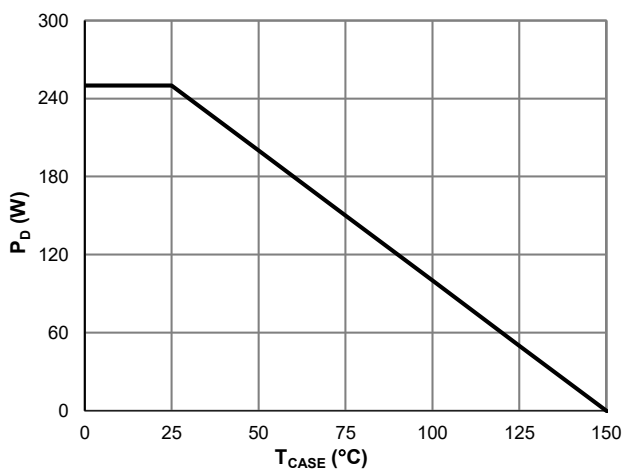

Figure 8: Power De-rating

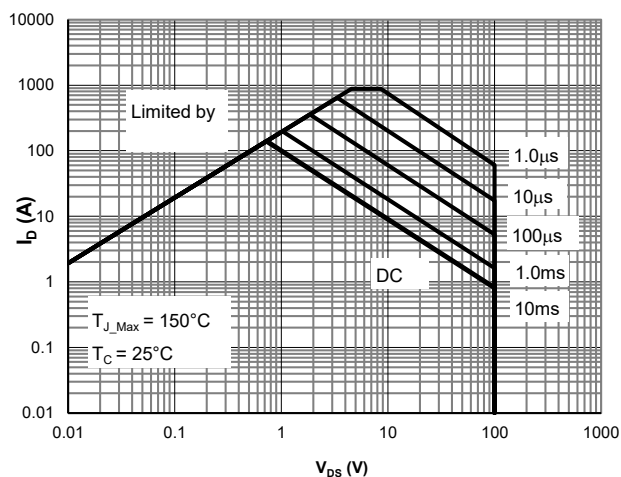

Figure 9: Maximum Forward Biased Safe Operating Area (Note F)

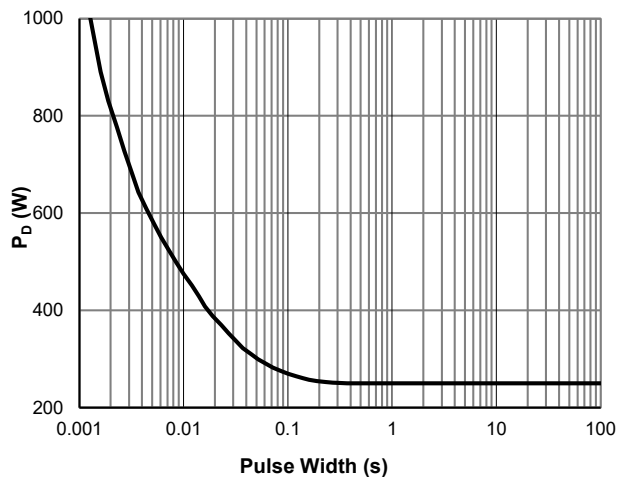

Figure 10: Single Pulse Power Rating, Junction-to-Case

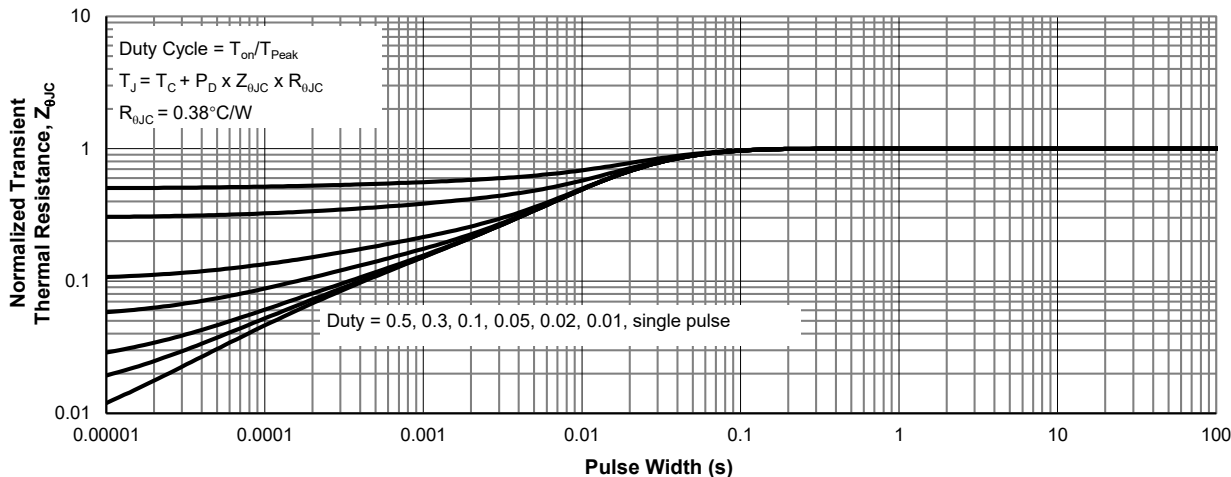
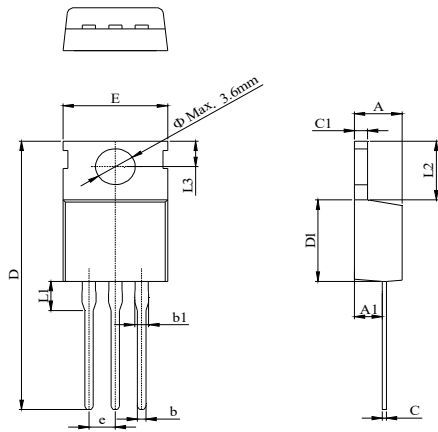

Figure 11: Normalized Maximum Transient Thermal Impedance



### TO-220-3L Package Information

#### Package Outline



DIM.	MILLIMETER		
	MIN.	NOM.	MAX.
A	4.37		4.70
A1	2.20		3.00
b	0.70		0.95
b1	1.14		1.70
C	0.45		0.60
C1	1.23		1.40
D	28.00		29.80
D1	8.80		9.90
E	9.70		10.50
L1			3.80
L2	6.25		6.90
L3	2.40		3.00
e		2.54 BSC	

### TO-263-3L Package Information

#### Package Outline

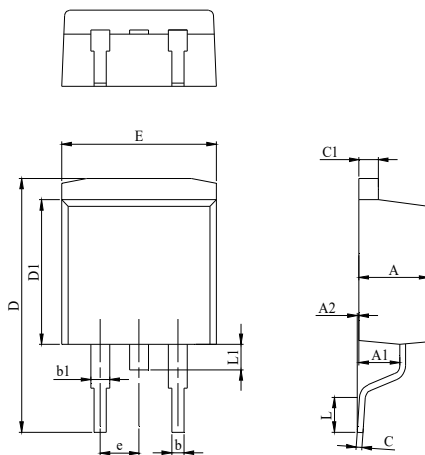

DIM.	MILLIMETER		
	MIN.	NOM.	MAX.
A	4.37		4.77
A1	2.30		2.89
A2	0.00	0.10	0.25
b	0.70		0.96
b1	1.17		1.47
C	0.30		0.55
C1	1.22		1.42
D	14.10		15.80
D1	8.50		9.60
E	9.86		10.36
L	2.00		2.60
L1			1.75
e		2.54	

#### Recommended Footprint

