



150V 6.7mΩ N-Ch Power MOSFET

Features

- Ultra-low $R_{DS(ON)}$
- Low Gate Charge
- 100% UIS Tested, 100% R_g Tested
- Pb-free Lead Plating
- Halogen-free and RoHS-compliant

Product Summary

Parameter	Value	Unit
V_{DS}	150	V
$V_{GS(th)}_{Typ}$	3.2	V
I_D (@ $V_{GS} = 10V$) ⁽¹⁾	98	A
$R_{DS(ON)}_{Typ}$ (@ $V_{GS} = 10V$)	6.7	mΩ

Applications

- Power Management in Telecom., Industrial Automation, CE
- Current Switching in DC/DC & AC/DC (SR) Sub-systems
- Motor Driving in Power Tool, E-vehicle, Robotics

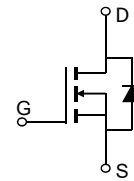
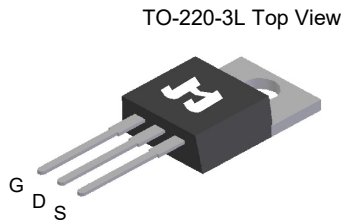

Ordering Information

Device	Package	# of Pins	Marking	MSL	T_J (°C)	Media	Quantity (pcs)
JMSH1508AC-U	TO-220-3L	3	SH1508A	N/A	-55 to 150	Tube	50
JMSH1508AE-13	TO-263-3L	3	SH1508A	1	-55 to 150	13-inch Reel	800

Absolute Maximum Ratings (@ $T_A = 25^\circ C$ unless otherwise specified)

Parameter	Symbol	Value	Unit
Drain-to-Source Voltage	V_{DS}	150	V
Gate-to-Source Voltage	V_{GS}	± 20	V
Continuous Drain Current ⁽¹⁾	I_D	$T_C = 25^\circ C$	98
		$T_C = 100^\circ C$	62
Pulsed Drain Current ⁽²⁾	I_{DM}	392	A
Avalanche Current ⁽³⁾	I_{AS}	42	A
Avalanche Energy ⁽³⁾	E_{AS}	265	mJ
Power Dissipation ⁽⁴⁾	P_D	$T_C = 25^\circ C$	192
		$T_C = 100^\circ C$	77
Junction & Storage Temperature Range	T_J, T_{STG}	-55 to 150	°C

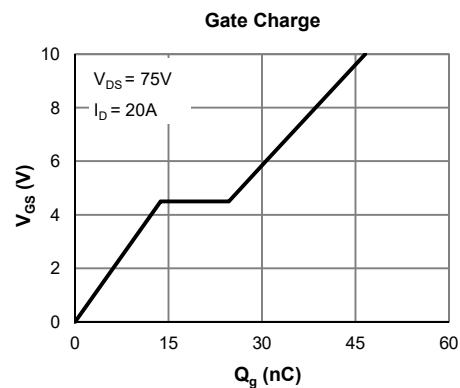
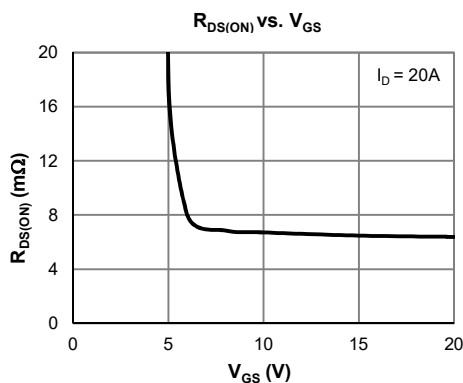



Electrical Characteristics (@ $T_J = 25^\circ\text{C}$ unless otherwise specified)

Parameter	Symbol	Conditions	Min.	Typ.	Max.	Unit	
STATIC PARAMETERS							
Drain-Source Breakdown Voltage	$V_{(BR)DSS}$	$I_D = 250\mu\text{A}, V_{GS} = 0\text{V}$	150			V	
Zero Gate Voltage Drain Current	I_{DSS}	$V_{DS} = 120\text{V}, V_{GS} = 0\text{V}$ $T_J = 55^\circ\text{C}$			1.0 5.0	μA	
Gate-Body Leakage Current	I_{GSS}	$V_{DS} = 0\text{V}, V_{GS} = \pm 20\text{V}$			± 100	nA	
Gate Threshold Voltage	$V_{GS(th)}$	$V_{DS} = V_{GS}, I_D = 250\mu\text{A}$	2.5	3.2	4.5	V	
Static Drain-Source ON-Resistance	$R_{DS(ON)}$	$V_{GS} = 10\text{V}, I_D = 20\text{A}$	TO-263-3L		6.7	8.4	$\text{m}\Omega$
			TO-220-3L		7.1	8.8	$\text{m}\Omega$
Forward Transconductance	g_{FS}	$V_{DS} = 5\text{V}, I_D = 20\text{A}$		71		S	
Diode Forward Voltage	V_{SD}	$I_S = 1\text{A}, V_{GS} = 0\text{V}$		0.71	1.0	V	
Diode Continuous Current	I_S	$T_C = 25^\circ\text{C}$			192	A	

DYNAMIC PARAMETERS ⁽⁵⁾

Input Capacitance	C_{ISS}	$V_{GS} = 0\text{V}, V_{DS} = 75\text{V}, f = 1\text{MHz}$		3395		pF
Output Capacitance	C_{OSS}			457		pF
Reverse Transfer Capacitance	C_{RSS}			17.4		pF
Gate Resistance	R_g	$V_{GS} = 0\text{V}, V_{DS} = 0\text{V}, f = 1\text{MHz}$		2.4		Ω

SWITCHING PARAMETERS ⁽⁵⁾

Total Gate Charge (@ $V_{GS} = 10\text{V}$)	Q_g	$V_{GS} = 0 \text{ to } 10\text{V}$ $V_{DS} = 75\text{V}, I_D = 20\text{A}$		47		nC
Total Gate Charge (@ $V_{GS} = 6.0\text{V}$)	Q_g			31		nC
Gate Source Charge	Q_{gs}			13.7		nC
Gate Drain Charge	Q_{gd}			11.0		nC
Turn-On DelayTime	$t_{D(on)}$	$V_{GS} = 10\text{V}, V_{DS} = 75\text{V}$ $R_L = 3.75\Omega, R_{GEN} = 6\Omega$		16.7		ns
Turn-On Rise Time	t_r			33		ns
Turn-Off DelayTime	$t_{D(off)}$			43		ns
Turn-Off Fall Time	t_f			36		ns
Body Diode Reverse Recovery Time	t_{rr}		$I_F = 15\text{A}, di_F/dt = 100\text{A}/\mu\text{s}$		112	
Body Diode Reverse Recovery Charge	Q_{rr}	$I_F = 15\text{A}, di_F/dt = 100\text{A}/\mu\text{s}$		182		nC

Thermal Performance

Parameter	Symbol	Typ.	Max.	Unit
Thermal Resistance, Junction-to-Ambient	$R_{\theta JA}$	45	55	$^\circ\text{C}/\text{W}$
Thermal Resistance, Junction-to-Case	$R_{\theta JC}$	0.52	0.65	$^\circ\text{C}/\text{W}$

Notes:

1. Computed continuous current assumes the condition of T_{J_Max} while the actual continuous current depends on the thermal & electro-mechanical application board design.
2. This single-pulse measurement was taken under $T_{J_Max} = 150^\circ\text{C}$.
3. This single-pulse measurement was taken under the following condition [$L = 300\mu\text{H}, V_{GS} = 10\text{V}, V_{DS} = 75\text{V}$] while its value is limited by $T_{J_Max} = 150^\circ\text{C}$.
4. The power dissipation P_D is based on $T_{J_Max} = 150^\circ\text{C}$.
5. This value is guaranteed by design hence it is not included in the production test.

Typical Electrical & Thermal Characteristics

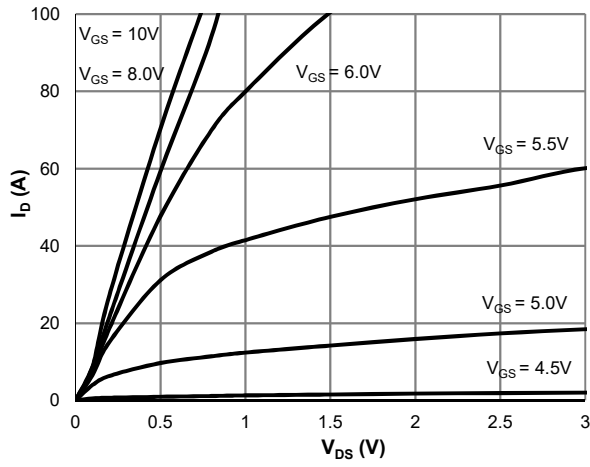

Figure 1: Saturation Characteristics

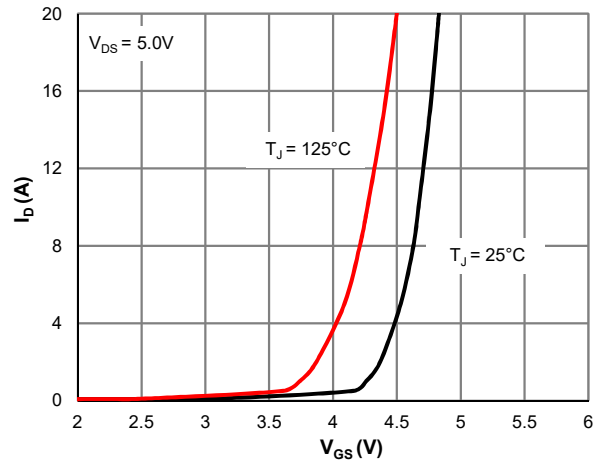

Figure 2: Transfer Characteristics

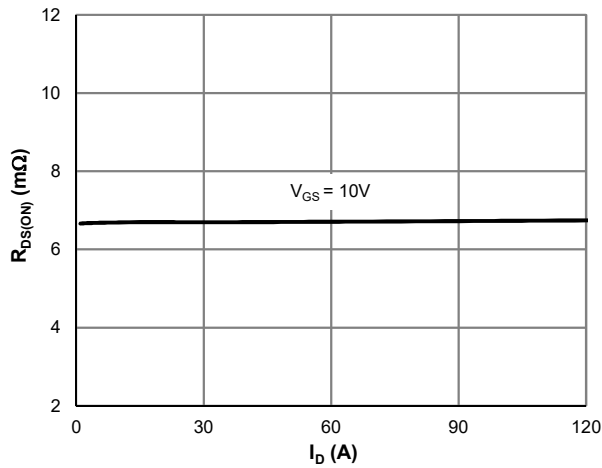

Figure 3: $R_{DS(ON)}$ vs. Drain Current

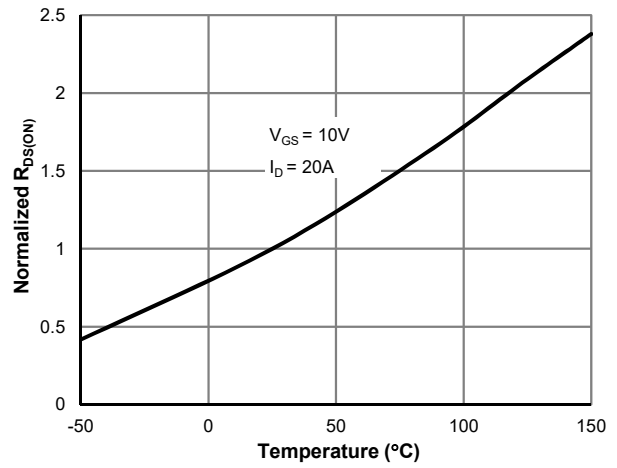

Figure 4: $R_{DS(ON)}$ vs. Junction Temperature

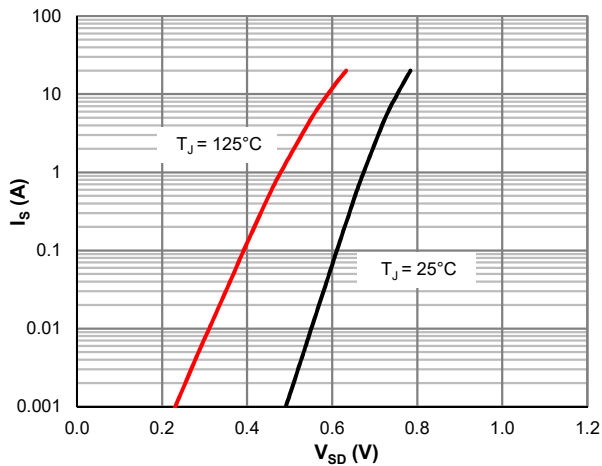

Figure 5: Body-Diode Characteristics

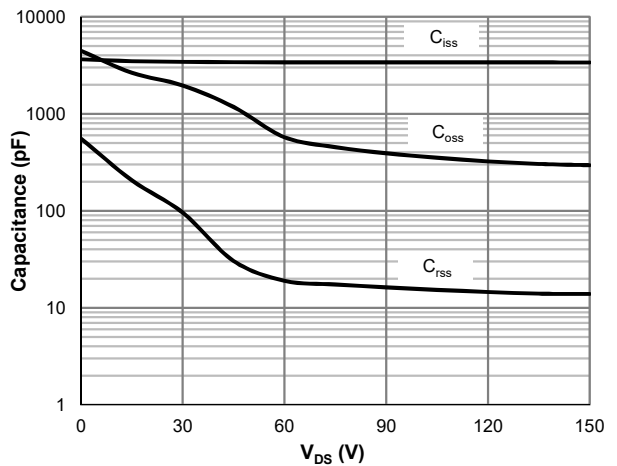

Figure 6: Capacitance Characteristics

Typical Electrical & Thermal Characteristics

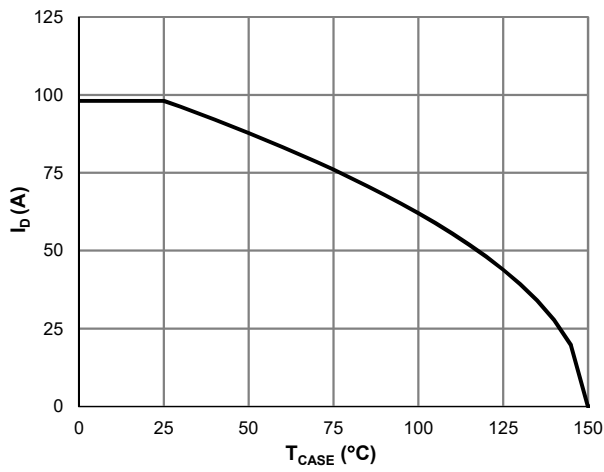

Figure 7: Current De-rating

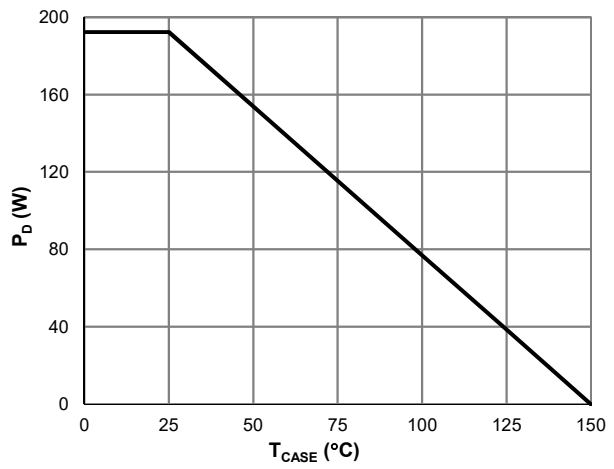

Figure 8: Power De-rating

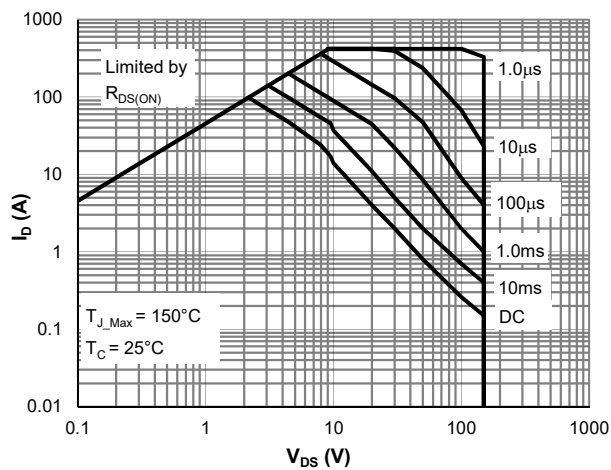

Figure 9: Maximum Safe Operating Area

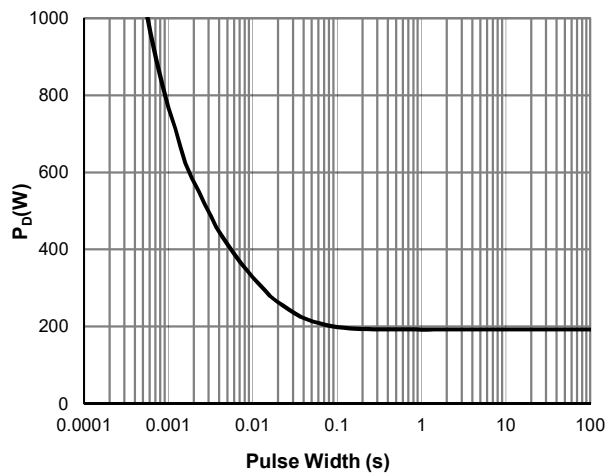

Figure 10: Single Pulse Power Rating, Junction-to-Case

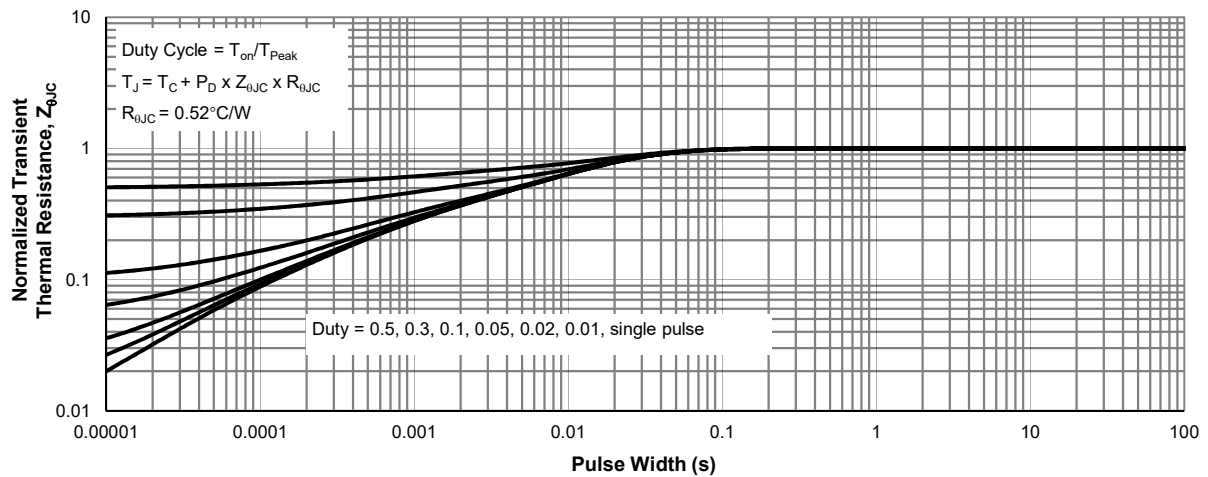
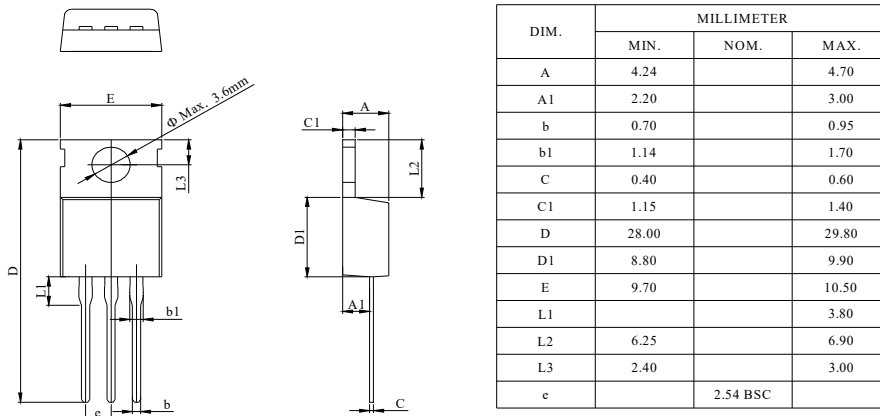

Figure 11: Normalized Maximum Transient Thermal Impedance

TO-220-3L Package Information

Package Outline



TO-263-3L Package Information

Package Outline

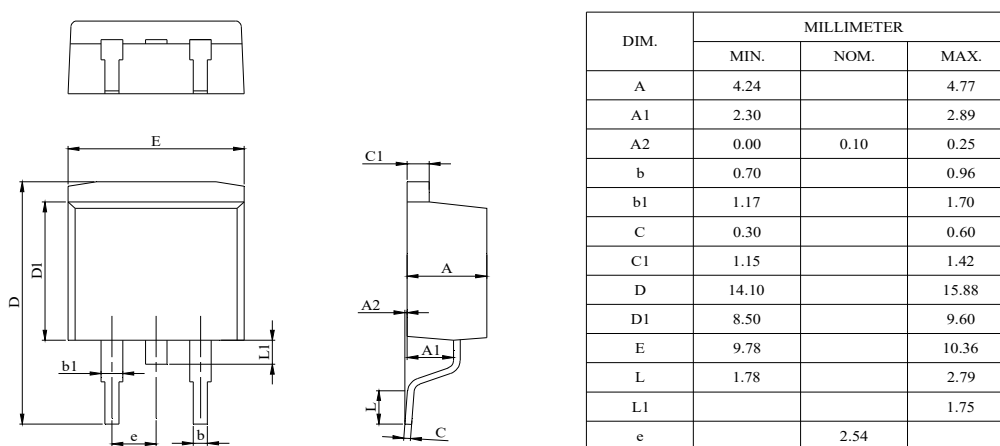

Recommended Footprint

