



100V 6.0mΩ N-Ch Power MOSFET

Features

- Ultra-low $R_{DS(ON)}$
- Low Gate Charge
- 100% UIS Tested, 100% R_g Tested
- Pb-free Lead Plating
- Halogen-free and RoHS-compliant

Product Summary

Parameter	Typ.	Unit
V_{DS}	100	V
$V_{GS(th)}$	1.7	V
I_D (@ $V_{GS} = 10V$) ⁽¹⁾	93	A
$R_{DS(ON)}$ (@ $V_{GS} = 10V$)	6.0	mΩ
$R_{DS(ON)}$ (@ $V_{GS} = 4.5V$)	8.0	mΩ

Applications

- Power Management in Telecom., Industrial Automation, CE
- Current Switching in DC/DC & AC/DC Sub-systems
- Motor Driving in Power Tool, E-vehicle, Robotics

PDFN5x6-8L

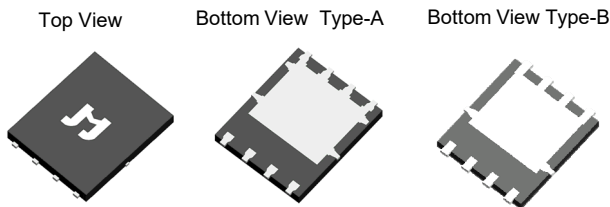

Pin Configuration
Top View

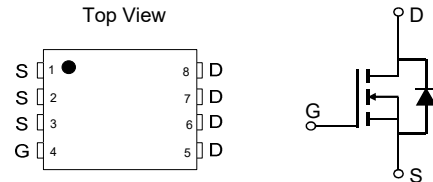

Ordering Information

Device	Package	# of Pins	Marking	MSL	T_J (°C)	Media	Quantity (pcs)
JMSL1008AG-13	PDFN5x6-8L	8	SL1008A	1	-55 to 150	13-inch Reel	3000

Absolute Maximum Ratings (@ $T_A = 25^\circ\text{C}$ unless otherwise specified)

Parameter	Symbol	Value	Unit
Drain-to-Source Voltage	V_{DS}	100	V
Gate-to-Source Voltage	V_{GS}	±20	V
Continuous Drain Current ⁽¹⁾	I_D	$T_C = 25^\circ\text{C}$	93
		$T_C = 100^\circ\text{C}$	54
Pulsed Drain Current ⁽²⁾	I_{DM}	210	A
Avalanche Current ⁽³⁾	I_{AS}	45	A
Avalanche Energy ⁽³⁾	E_{AS}	101	mJ
Power Dissipation ⁽⁴⁾	P_D	$T_C = 25^\circ\text{C}$	104
		$T_C = 100^\circ\text{C}$	42
Junction & Storage Temperature Range	T_J, T_{STG}	-55 to 150	°C

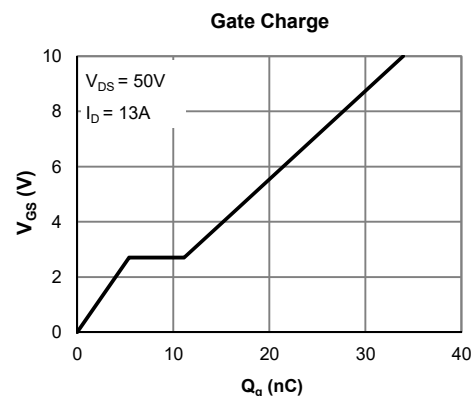
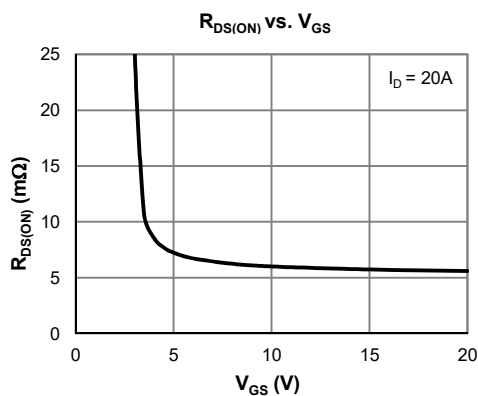

**Electrical Characteristics** (@ $T_J = 25^\circ\text{C}$ unless otherwise specified)

Parameter	Symbol	Conditions	Min.	Typ.	Max.	Unit
STATIC PARAMETERS						
Drain-Source Breakdown Voltage	$V_{(BR)DSS}$	$I_D = 250\mu\text{A}, V_{GS} = 0\text{V}$	100			V
Zero Gate Voltage Drain Current	I_{DSS}	$V_{DS} = 80\text{V}, V_{GS} = 0\text{V}$ $T_J = 55^\circ\text{C}$			1.0 5.0	μA
Gate-Body Leakage Current	I_{GSS}	$V_{DS} = 0\text{V}, V_{GS} = \pm 20\text{V}$			± 100	nA
Gate Threshold Voltage	$V_{GS(th)}$	$V_{DS} = V_{GS}, I_D = 250\mu\text{A}$	1.2	1.7	2.5	V
Static Drain-Source ON-Resistance	$R_{DS(on)}$	$V_{GS} = 10\text{V}, I_D = 20\text{A}$		6.0	7.6	$\text{m}\Omega$
		$V_{GS} = 4.5\text{V}, I_D = 15\text{A}$		8.0	10.0	$\text{m}\Omega$
Forward Transconductance	g_{FS}	$V_{DS} = 5\text{V}, I_D = 20\text{A}$		82		S
Diode Forward Voltage	V_{SD}	$I_S = 1\text{A}, V_{GS} = 0\text{V}$		0.72	1.0	V
Diode Continuous Current	I_S	$T_C = 25^\circ\text{C}$			104	A
DYNAMIC PARAMETERS ⁽⁵⁾						
Input Capacitance	C_{iss}	$V_{GS} = 0\text{V}, V_{DS} = 50\text{V}, f = 1\text{MHz}$		2200		pF
Output Capacitance	C_{oss}			445		pF
Reverse Transfer Capacitance	C_{rss}			8.0		pF
Gate Resistance	R_g	$V_{GS} = 0\text{V}, V_{DS} = 0\text{V}, f = 1\text{MHz}$		1.8		Ω
SWITCHING PARAMETERS ⁽⁵⁾						
Total Gate Charge (@ $V_{GS} = 10\text{V}$)	Q_g	$V_{GS} = 0 \text{ to } 10\text{V}$ $V_{DS} = 50\text{V}, I_D = 13\text{A}$		34		nC
Total Gate Charge (@ $V_{GS} = 4.5\text{V}$)	Q_g			17.0		nC
Gate Source Charge	Q_{gs}			5.5		nC
Gate Drain Charge	Q_{gd}			5.7		nC
Turn-On Delay Time	$t_{D(on)}$	$V_{GS} = 10\text{V}, V_{DS} = 50\text{V}$ $R_L = 3.8\Omega, R_{GEN} = 6\Omega$		13.0		ns
Turn-On Rise Time	t_r			14.0		ns
Turn-Off Delay Time	$t_{D(off)}$			29		ns
Turn-Off Fall Time	t_f			17.0		ns
Body Diode Reverse Recovery Time	t_{rr}		$I_F = 13\text{A}, di_F/dt = 100\text{A}/\mu\text{s}$		51	
Body Diode Reverse Recovery Charge	Q_{rr}	$I_F = 13\text{A}, di_F/dt = 100\text{A}/\mu\text{s}$		90		nC

Thermal Performance

Parameter	Symbol	Typ.	Max.	Unit
Thermal Resistance, Junction-to-Ambient	$R_{\theta JA}$	50	65	$^\circ\text{C}/\text{W}$
Thermal Resistance, Junction-to-Case	$R_{\theta JC}$	1.0	1.2	$^\circ\text{C}/\text{W}$

Notes:

1. Computed continuous current assumes the condition of T_{J_Max} while the actual continuous current depends on the thermal & electro-mechanical application board design.
2. This single-pulse measurement was taken under $T_{J_Max} = 150^\circ\text{C}$.
3. This single-pulse measurement was taken under the following condition [$L = 100\mu\text{H}, V_{GS} = 10\text{V}, V_{DS} = 50\text{V}$] while its value is limited by $T_{J_Max} = 150^\circ\text{C}$.
4. The power dissipation P_D is based on $T_{J_Max} = 150^\circ\text{C}$.
5. This value is guaranteed by design hence it is not included in the production test.

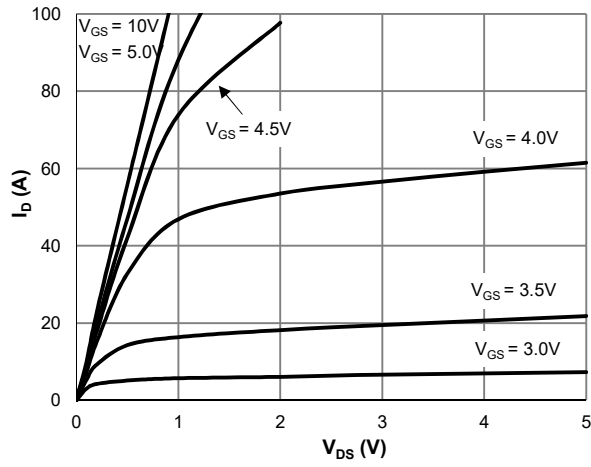
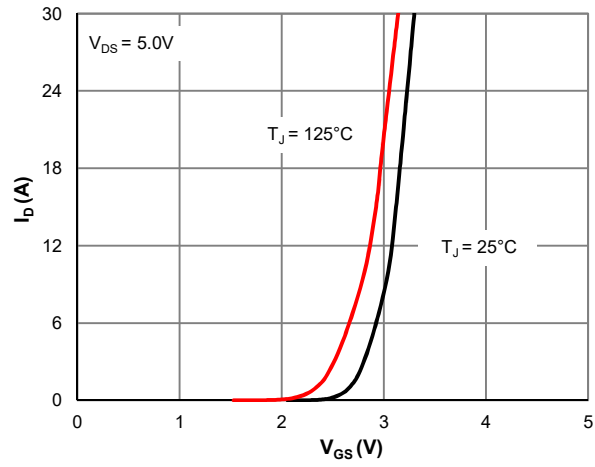
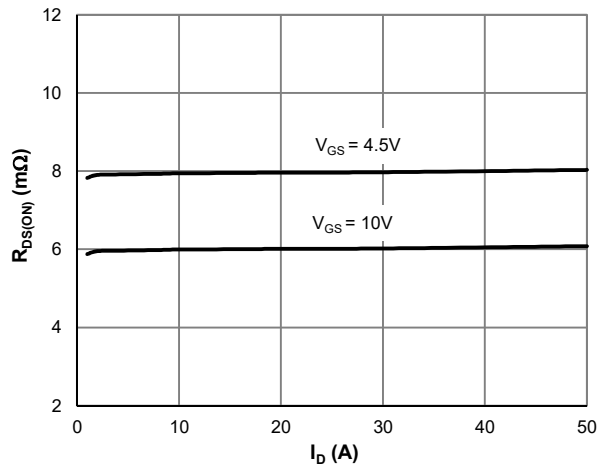
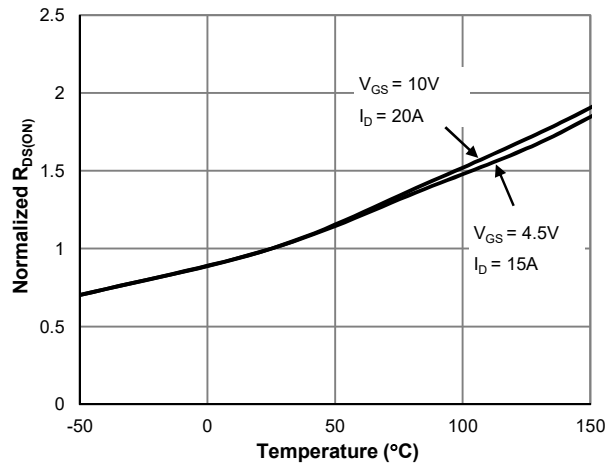
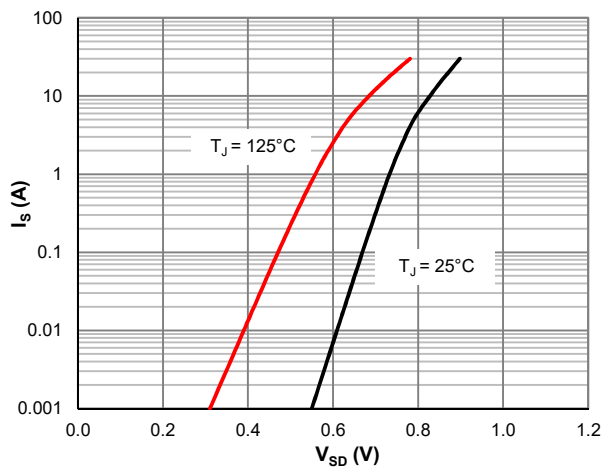
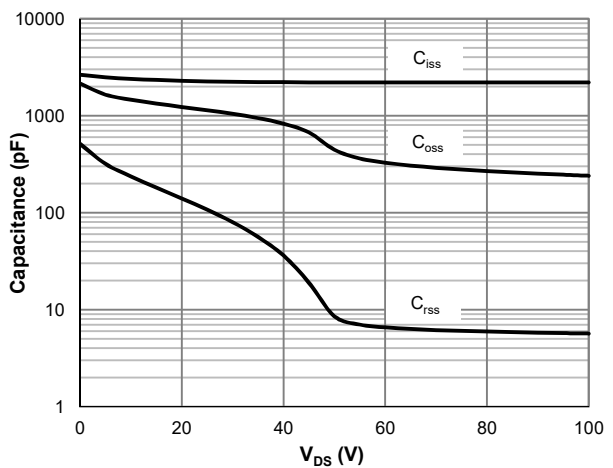
Typical Electrical & Thermal Characteristics

Figure 1: Saturation Characteristics

Figure 2: Transfer Characteristics

Figure 3: $R_{DS(ON)}$ vs. Drain Current

Figure 4: $R_{DS(ON)}$ vs. Junction Temperature

Figure 5: Body-Diode Characteristics

Figure 6: Capacitance Characteristics

Typical Electrical & Thermal Characteristics

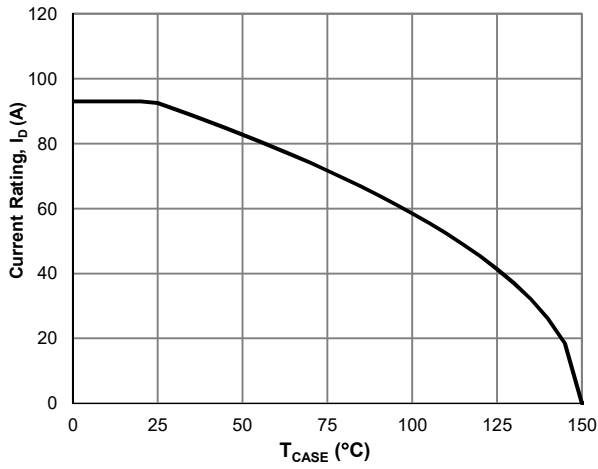

Figure 7: Current De-rating

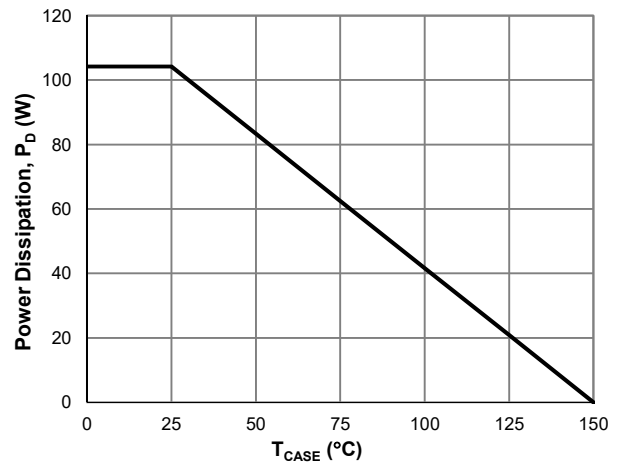

Figure 8: Power De-rating

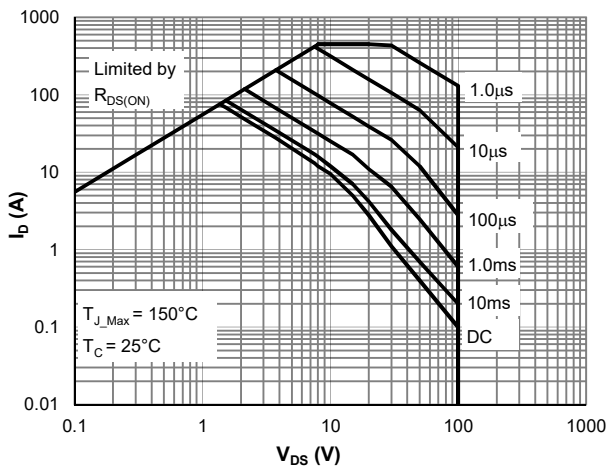

Figure 9: Maximum Safe Operating

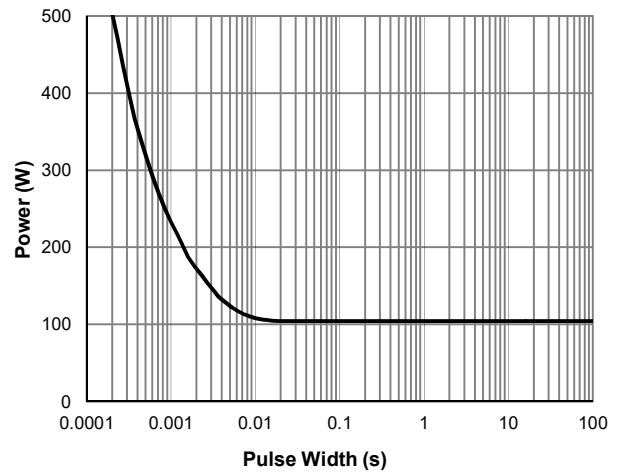

Figure 10: Single Pulse Power Rating, Junction-to-Case

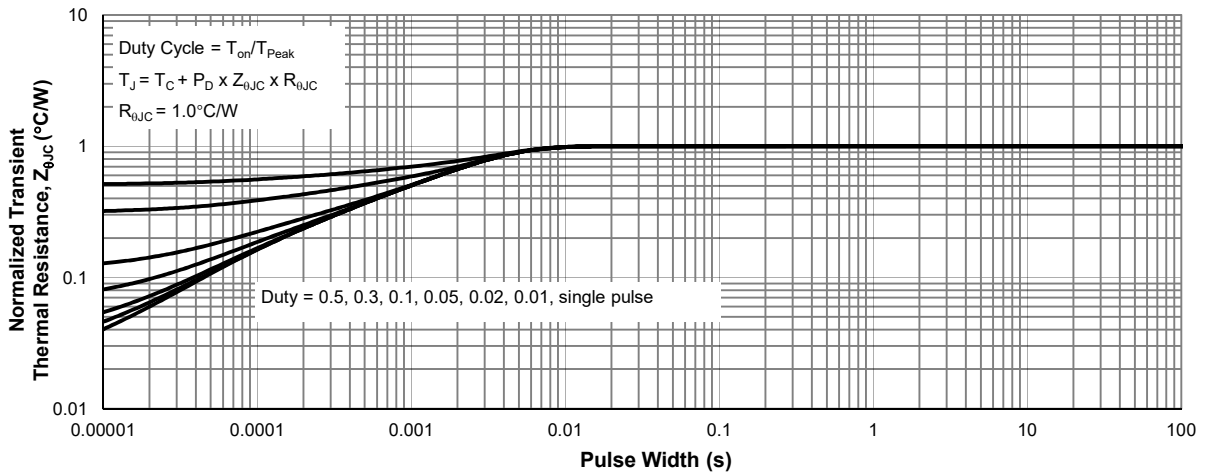
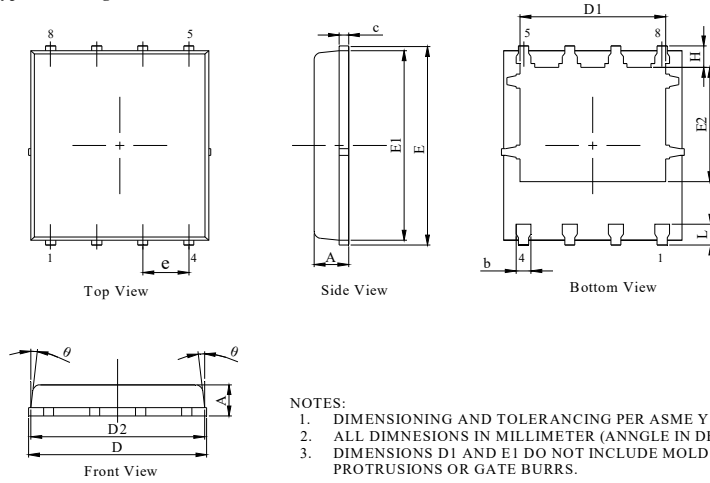
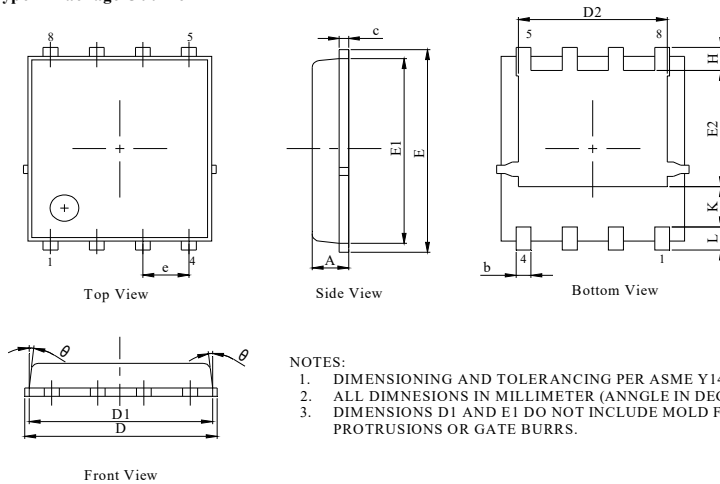

Figure 11: Normalized Maximum Transient Thermal Impedance

PDFN5x6-8L Package Information
Type-A Package Outline

DIM.	MILLIMETER		
	MIN.	NOM.	MAX.
A	0.90	1.00	1.10
b	0.20	0.30	0.40
c	0.21	0.25	0.34
D	4.90	5.00	5.10
D1	3.91	4.01	4.11
D2	4.80	4.90	5.00
E	5.90	6.00	6.10
E1	5.65	5.75	5.85
E2	3.37	3.48	3.58
e	1.27BSC		
H	0.55	0.65	0.75
L	0.55	0.65	0.75
θ	0°	--	12°

Type-B Package Outline

DIM.	MILLIMETER		
	MIN.	NOM.	MAX.
A	0.90	1.00	1.10
b	0.31	0.41	0.51
c	0.20	0.25	0.30
D	5.00	5.20	5.40
D1	4.95	5.05	5.15
D2	4.00	4.10	4.20
E	6.05	6.15	6.25
E1	5.50	5.60	5.70
E2	3.42	3.53	3.63
e	1.27BSC		
H	0.60	0.70	0.80
L	0.50	0.70	0.80
θ	-	-	10°

Recommended Soldering Footprint
