



100V 99mΩ Dual N-Ch Power MOSFET

Features

- Low Gate Charge
- Fast Switching
- 100% UIS Tested, 100% R_g Tested
- Pb-free Lead Plating
- Halogen-free and RoHS-compliant

Product Summary

Parameter	Value	Unit
V _{DS}	100	V
V _{GS(th)_Typ}	1.7	V
I _D (@ V _{GS} = 10V) ⁽¹⁾	10	A
R _{DS(ON)_Typ} (@ V _{GS} = 10V)	99	mΩ
R _{DS(ON)_Typ} (@ V _{GS} = 4.5V)	120	mΩ

Applications

- Power Management in Telecom., Industrial Automation, CE
- Motor Driving in Power Tool, E-vehicle, Robotics
- Current Switching in DC/DC & AC/DC (SR) Sub-systems

PDFN5x6-8L-D

Top View

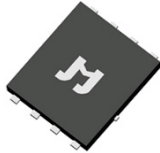

Bottom View

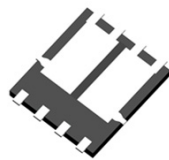

Pin Configuration
Top View

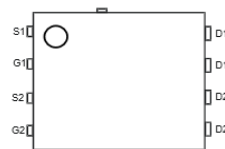

Chip-1 & Chip-2

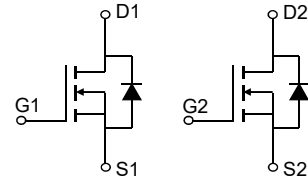

Ordering Information

Device	Package	# of Pins	Marking	MSL	T _J (°C)	Media	Quantity (pcs)
JMSL10130AGD-13	PDFN5x6-8L-D	8	L10130AD	1	-55 to 150	13-inch Reel	3000

Absolute Maximum Ratings (@ T_A = 25°C unless otherwise specified)

Parameter	Symbol	Value	Unit
Drain-to-Source Voltage	V _{DS}	100	V
Gate-to-Source Voltage	V _{GS}	±20	V
Continuous Drain Current ⁽¹⁾	I _D	T _C = 25°C	10.5
		T _C = 100°C	6.6
Pulsed Drain Current ⁽²⁾	I _{DM}	32	A
Avalanche Current ⁽³⁾	I _{AS}	4.2	A
Avalanche Energy ⁽³⁾	E _{AS}	0.9	mJ
Power Dissipation ⁽⁴⁾	P _D	T _C = 25°C	24
		T _C = 100°C	9.4
Junction & Storage Temperature Range	T _J , T _{STG}	-55 to 150	°C

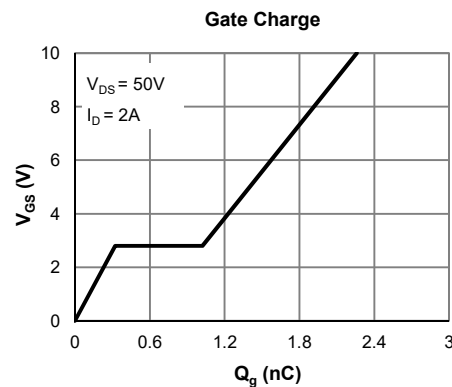
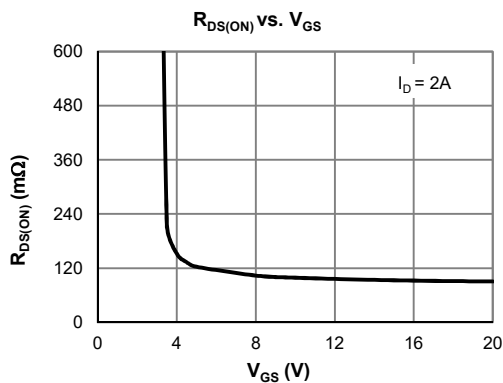

**Electrical Characteristics** (@ $T_J = 25^\circ\text{C}$ unless otherwise specified)

Parameter	Symbol	Conditions	Min.	Typ.	Max.	Unit
STATIC PARAMETERS						
Drain-Source Breakdown Voltage	$V_{(BR)DSS}$	$I_D = 250\mu\text{A}$, $V_{GS} = 0\text{V}$	100			V
Zero Gate Voltage Drain Current	I_{DSS}	$V_{DS} = 80\text{V}$, $V_{GS} = 0\text{V}$			1.0	μA
					5.0	
Gate-Body Leakage Current	I_{GSS}	$V_{DS} = 0\text{V}$, $V_{GS} = \pm 20\text{V}$			± 100	nA
Gate Threshold Voltage	$V_{GS(th)}$	$V_{DS} = V_{GS}$, $I_D = 250\mu\text{A}$	1.2	1.7	2.5	V
Static Drain-Source ON-Resistance	$R_{DS(on)}$	$V_{GS} = 10\text{V}$, $I_D = 2\text{A}$		99	124	$\text{m}\Omega$
			$V_{GS} = 4.5\text{V}$, $I_D = 1\text{A}$		120	156
Forward Transconductance	g_{FS}	$V_{DS} = 5\text{V}$, $I_D = 2\text{A}$		6.8		S
Diode Forward Voltage	V_{SD}	$I_S = 1\text{A}$, $V_{GS} = 0\text{V}$		0.68	1.0	V
Diode Continuous Current	I_S	$T_C = 25^\circ\text{C}$			24	A
DYNAMIC PARAMETERS ⁽⁵⁾						
Input Capacitance	C_{iss}	$V_{GS} = 0\text{V}$, $V_{DS} = 50\text{V}$, $f = 1\text{MHz}$		103		pF
Output Capacitance	C_{oss}			47		pF
Reverse Transfer Capacitance	C_{rss}			4.9		pF
Gate Resistance	R_g	$V_{GS} = 0\text{V}$, $V_{DS} = 0\text{V}$, $f = 1\text{MHz}$		2.6		Ω
SWITCHING PARAMETERS ⁽⁵⁾						
Total Gate Charge (@ $V_{GS} = 10\text{V}$)	Q_g	$V_{GS} = 0$ to 10V $V_{DS} = 50\text{V}$, $I_D = 2\text{A}$		2.3		nC
Total Gate Charge (@ $V_{GS} = 4.5\text{V}$)	Q_g			1.3		nC
Gate Source Charge	Q_{gs}			0.30		nC
Gate Drain Charge	Q_{gd}			0.70		nC
Turn-On Delay Time	$t_{D(on)}$	$V_{GS} = 10\text{V}$, $V_{DS} = 50\text{V}$ $R_L = 25\Omega$, $R_{GEN} = 6\Omega$		2.1		ns
Turn-On Rise Time	t_r			3.3		ns
Turn-Off Delay Time	$t_{D(off)}$			7.5		ns
Turn-Off Fall Time	t_f			3.2		ns
Body Diode Reverse Recovery Time	t_{rr}	$I_F = 2\text{A}$, $dI_F/dt = 100\text{A}/\mu\text{s}$		21		ns
Body Diode Reverse Recovery Charge	Q_{rr}	$I_F = 2\text{A}$, $dI_F/dt = 100\text{A}/\mu\text{s}$		8.0		nC

Thermal Performance

Parameter	Symbol	Typ.	Max.	Unit
Thermal Resistance, Junction-to-Ambient	$R_{\theta JA}$	48	58	$^\circ\text{C}/\text{W}$
Thermal Resistance, Junction-to-Case	$R_{\theta JC}$	4.2	5.3	$^\circ\text{C}/\text{W}$

Notes:

1. Computed continuous current assumes the condition of T_{J_Max} while the actual continuous current depends on the thermal & electro-mechanical application board design.
2. This single-pulse measurement was taken under $T_{J_Max} = 150^\circ\text{C}$.
3. This single-pulse measurement was taken under the following condition [$L = 100\mu\text{H}$, $V_{GS} = 10\text{V}$, $V_{DS} = 50\text{V}$] while its value is limited by $T_{J_Max} = 150^\circ\text{C}$.
4. The power dissipation P_D is based on $T_{J_Max} = 150^\circ\text{C}$.
5. This value is guaranteed by design hence it is not included in the production test.



Typical Electrical & Thermal Characteristics

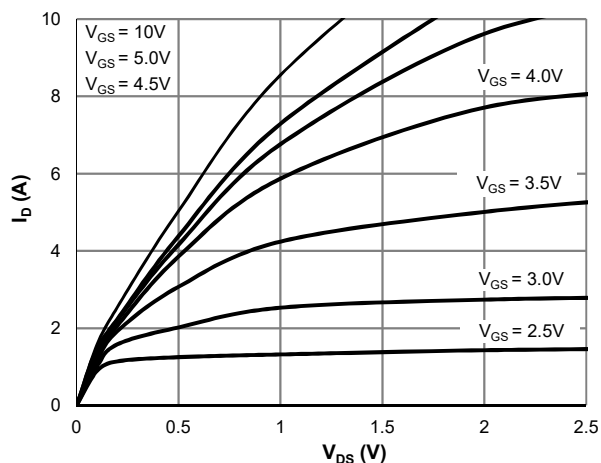

Figure 1: Saturation Characteristics

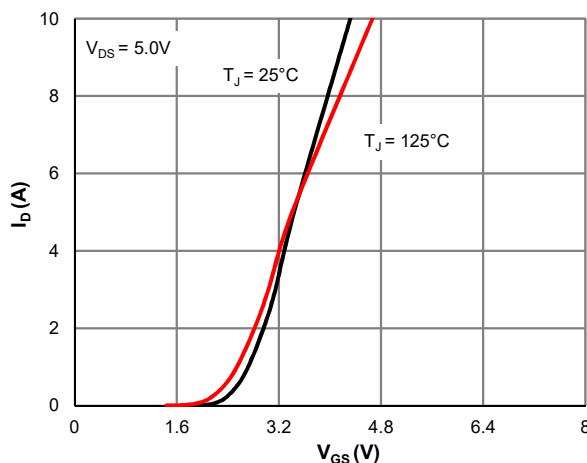

Figure 2: Transfer Characteristics

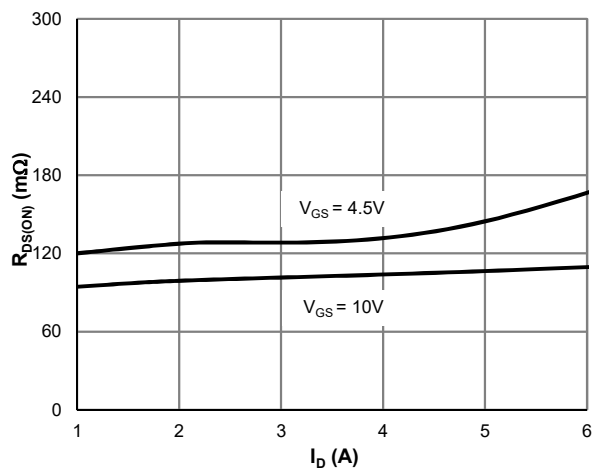

Figure 3: $R_{DS(ON)}$ vs. Drain Current

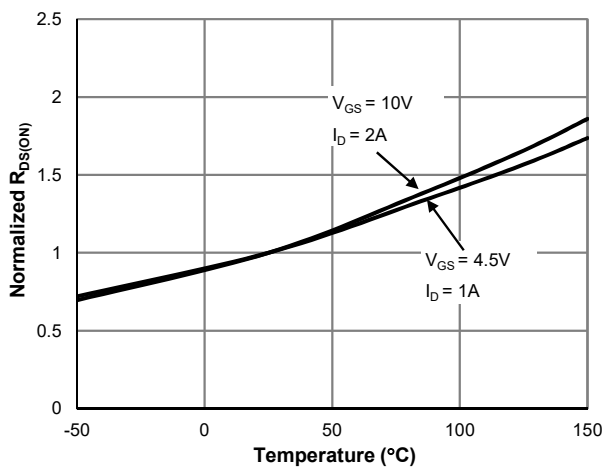

Figure 4: $R_{DS(ON)}$ vs. Junction Temperature

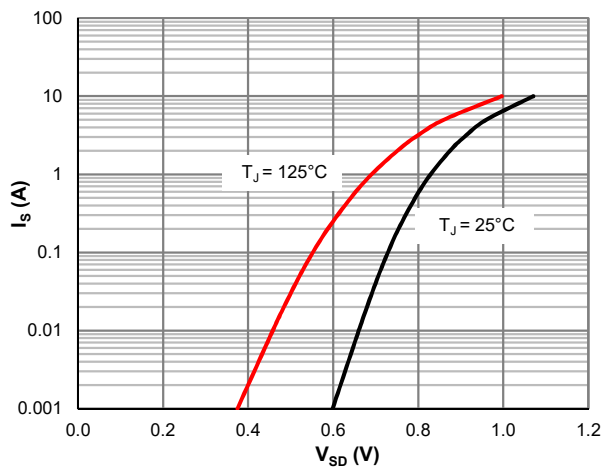

Figure 5: Body-Diode Characteristics

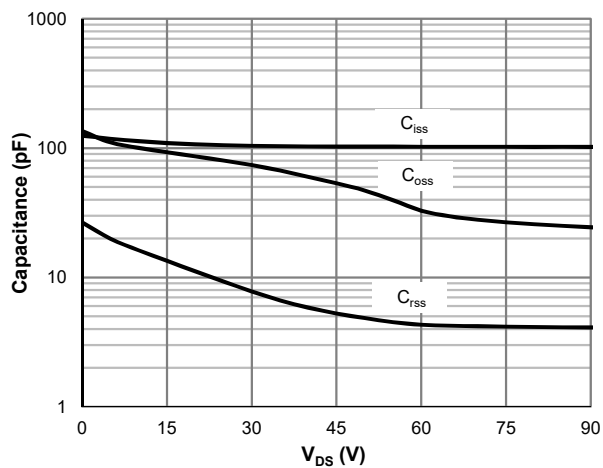

Figure 6: Capacitance Characteristics

Typical Electrical & Thermal Characteristics

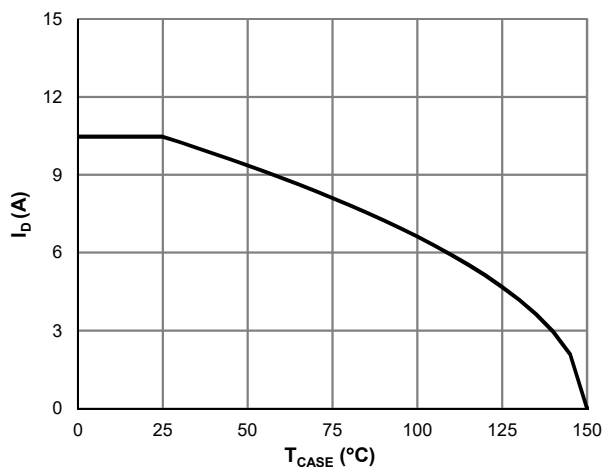

Figure 7: Current De-rating

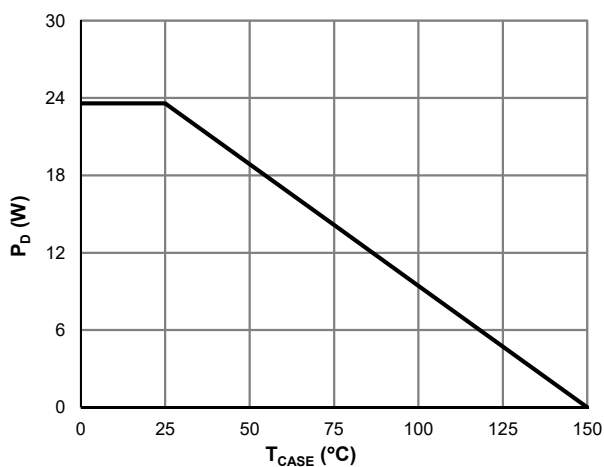

Figure 8: Power De-rating

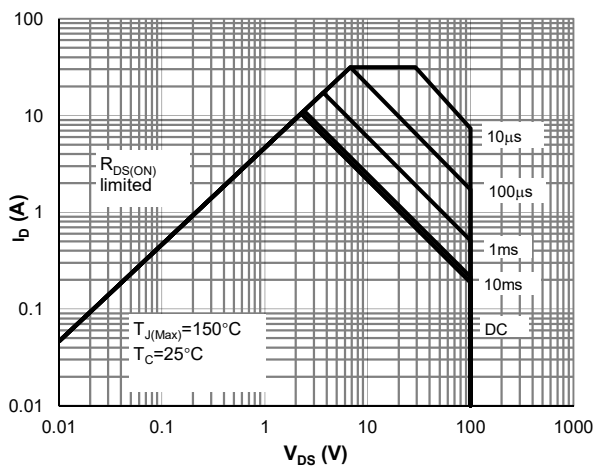

Figure 9: Maximum Safe Operating Area

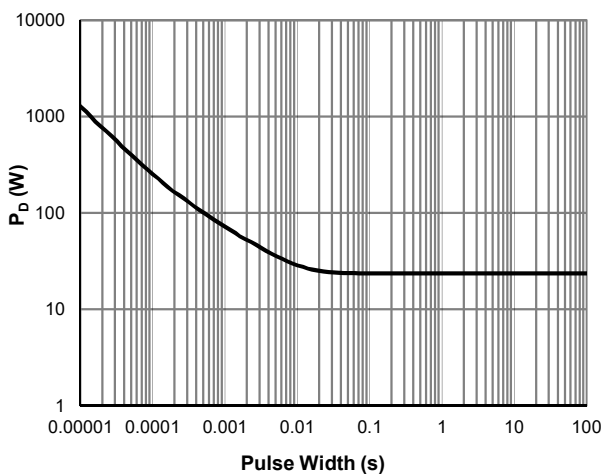

Figure 10: Single Pulse Power Rating, Junction-to-Case

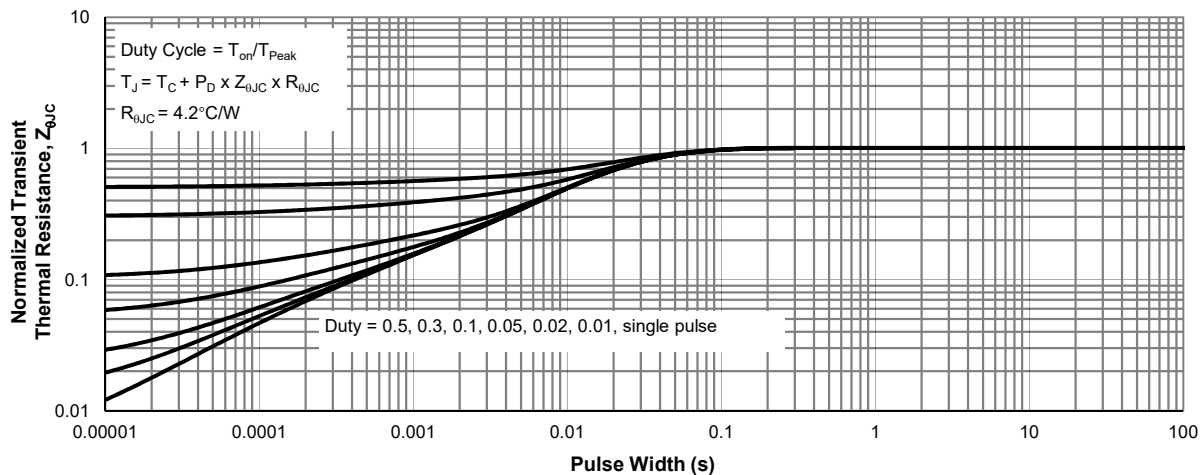
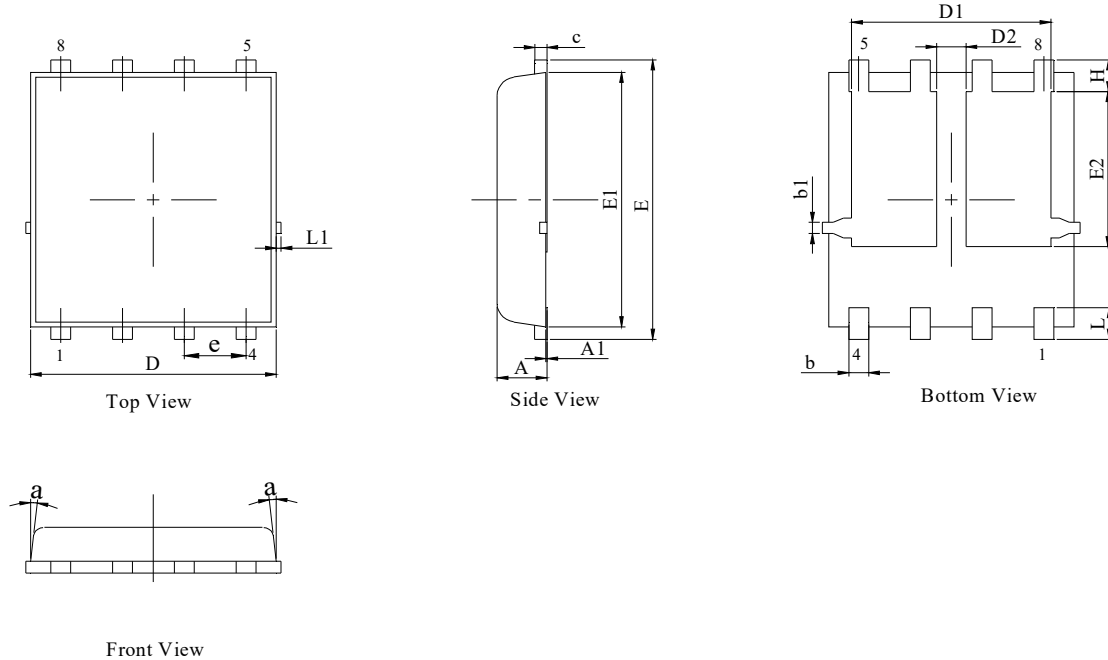
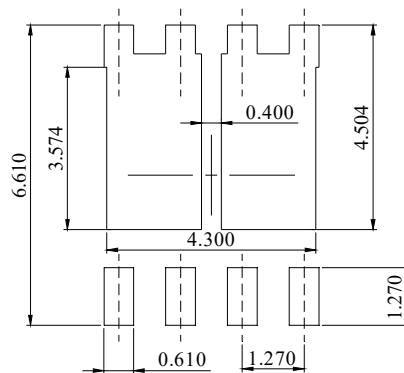

Figure 11: Normalized Maximum Transient Thermal Impedance

PDFN5x6-8L-D Package Information
Package Outline

NOTES:

1. DIMENSIONING AND TOLERANCING PER ASME Y14.5M,1994.
2. ALL DIMENSIONS IN MILLIMETER (ANGLE IN DEGREE).
3. DIMENSIONS D1 AND E1 DO NOT INCLUDE MOLD FLASH PROTRUSIONS OR GATE BURRS.

DIM.	MILLIMETER		
	MIN.	NOM.	MAX.
A	0.90	1.00	1.10
A1	0.00	-	0.10
b	0.31	0.41	0.51
b1	0.15	0.25	0.35
c	0.23	-	0.33
D	4.95	5.05	5.15
D1	4.00	4.10	4.20
D2	0.50	0.60	0.70
E	6.05	6.15	6.25
E1	5.50	5.60	5.70
E2	3.31	3.41	3.51
e	1.27BSC		
H	0.60	0.70	0.80
L	0.50	0.70	0.80
L1	-	-	0.125
a	-	-	12°

Recommended Soldering Footprint

DIMENSIONS: MILLIMETERS