



15KP Series 15000W Transient Voltage Suppressor

Rev.2.6

DESCRIPTION:

The 15KP series of high current uni/bi-directional transient suppressors are designed for A.C. line protection and high power DC bus clamping applications. These devices offer uni/bi-directional port protection from 17 volts to 280 volts. They provide a clamping voltage lower than the avalanche voltage. Therefore, any voltage rise due to increased current conduction is contained to a minimum, providing the best possible protection level. They can also be connected in series and/or parallel to create very high capacity protection solutions.

FEATURES:

- ✧ Low incremental surge resistance.
- ✧ Excellent clamping capability.
- ✧ Typical I_R less than $2\mu A$ above 30V.
- ✧ Color band denoted cathode except bidirectional.
- ✧ High temperature soldering: $265^\circ C/10s$ at terminals.
- ✧ Plastic package has under writers laboratory flammability 94V-0.
- ✧ 15000W peak pulse power capability at 10/1000 μs waveform.
- ✧ Meets MSL level 1, per J-STD-020, LF maximum peak of $260^\circ C$.
- ✧ Terminal: solder plated, solderable per J-STD-002.
- ✧ Fast response time: typically less than 1.0ps from 0V to V_{BR} min.
- ✧ UL 497B item recognized. (File No.:E480698).
- ✧ IEC61000-4-2 (ESD) $\pm 30kV$ (air), $\pm 30kV$ (contact).

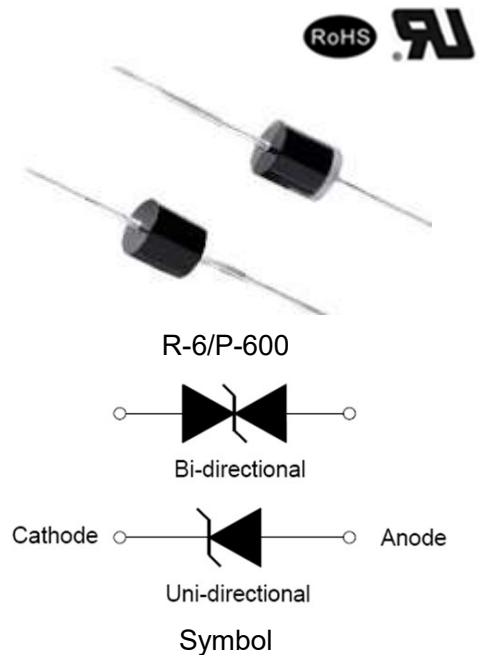

ABSOLUTE MAXIMUM RATINGS ($T_A=25^\circ C$, RH=45%-75%, unless otherwise noted)

Parameter	Symbol	Value	Unit
Operating junction and storage temperature range	T_J, T_{STG}	-55 to +175	$^\circ C$
Peak pulse power dissipation at 10/1000 μs waveform	P_{PP}	15000	W
Steady state power dissipation at $T_L=75^\circ C$	$P_{M(AV)}$	8.0	W
Peak forward surge current, 8.3ms single half sine-wave for unidirectional only	I_{FSM}	400	A

ABSOLUTE MAXIMUM RATINGS($T_A=25^{\circ}\text{C}$, RH=45%-75%, unless otherwise noted, continued)

Parameter	Symbol	Value	Unit
Typical thermal resistance junction to lead	$R_{\theta JL}$	8.0	$^{\circ}\text{C/W}$
Typical thermal resistance junction to ambient	$R_{\theta JA}$	40	$^{\circ}\text{C/W}$

ELECTRICAL CHARACTERISTICS ($T_A=25^{\circ}\text{C}$)

Part Number		V_R	$I_R@V_R$	$V_{BR}@I_T$		I_T	$V_C@I_{PP}$	I_{PP}°
Uni-Polar	Bi-Polar	V	max(μA)	min(V)	max(V)	mA	max(V)	A
15KP17A	15KP17CA	17.0	5000	18.90	20.90	50	29.3	515.4
15KP18A	15KP18CA	18.0	5000	20.00	22.10	50	30.9	488.7
15KP20A	15KP20CA	20.0	1500	22.20	24.50	20	34.3	440.2
15KP22A	15KP22CA	22.0	500	24.40	26.90	10	37.1	407.0
15KP24A	15KP24CA	24.0	150	26.70	29.50	5	40.7	371.0
15KP26A	15KP26CA	26.0	50	28.90	31.90	5	44.0	343.2
15KP28A	15KP28CA	28.0	25	31.10	34.40	5	47.5	317.9
15KP30A	15KP30CA	30.0	15	33.30	36.80	5	50.7	297.8
15KP33A	15KP33CA	33.0	2	36.70	40.60	5	54.7	276.1
15KP36A	15KP36CA	36.0	2	40.00	44.20	5	59.8	252.5
15KP40A	15KP40CA	40.0	2	44.40	49.10	5	65.8	229.5
15KP43A	15KP43CA	43.0	2	47.80	52.80	5	69.8	216.3
15KP45A	15KP45CA	45.0	2	50.00	55.30	5	72.8	207.4
15KP48A	15KP48CA	48.0	2	53.30	58.90	5	77.7	194.3
15KP51A	15KP51CA	51.0	2	56.70	62.70	5	82.9	182.1
15KP54A	15KP54CA	54.0	2	60.00	66.30	5	87.7	172.2
15KP58A	15KP58CA	58.0	2	64.40	71.20	5	93.8	161.0
15KP60A	15KP60CA	60.0	2	66.70	73.70	5	97.4	155.0
15KP64A	15KP64CA	64.0	2	71.10	78.60	5	104.2	144.9
15KP70A	15KP70CA	70.0	2	77.80	86.00	5	113.6	132.9
15KP75A	15KP75CA	75.0	2	83.30	92.10	5	122.0	123.8
15KP78A	15KP78CA	78.0	2	86.70	95.80	5	126.1	119.7
15KP85A	15KP85CA	85.0	2	94.40	104.0	5	137.6	109.7
15KP90A	15KP90CA	90.0	2	100.0	111.0	5	145.6	103.7

ELECTRICAL CHARACTERISTICS ($T_A=25^{\circ}\text{C}$, continued)

Part Number		V_R	$I_R@V_R$	$V_{BR}@I_T$		I_T	$V_C@I_{PP}$	I_{PP}°
Uni-Polar	Bi-Polar	V	max(μA)	min(V)	max(V)	mA	max(V)	A
15KP100A	15KP100CA	100.0	2	111.0	123.0	5	161.3	93.6
15KP110A	15KP110CA	110.0	2	122.0	135.0	5	178.6	84.5
15KP120A	15KP120CA	120.0	2	133.0	147.0	5	192.3	78.5
15KP130A	15KP130CA	130.0	2	144.0	159.0	5	208.3	72.5
15KP150A	15KP150CA	150.0	2	167.0	185.0	5	241.9	62.4
15KP160A	15KP160CA	160.0	2	178.0	197.0	5	258.6	58.4
15KP170A	15KP170CA	170.0	2	189.0	209.0	5	272.7	55.4
15KP180A	15KP180CA	180.0	2	201.0	222.0	5	288.5	52.3
15KP200A	15KP200CA	200.0	2	224.0	247.0	5	319.1	47.3
15KP220A	15KP220CA	220.0	2	246.0	272.0	5	352.5	42.8
15KP240A	15KP240CA	240.0	2	268.0	292.0	5	384.6	39.3
15KP260A	15KP260CA	260.0	2	289.0	317.0	5	416.7	36.2
15KP280A	15KP280CA	280.0	2	311.0	341.0	5	454.5	33.2

① Surge waveform: 10/1000 μs

V_R : Stand-off voltage -- Maximum voltage that can be applied

V_{BR} : Breakdown voltage

V_C : Clamping voltage -- Peak voltage measured across the suppressor at a specified I_{PP}

I_R : Reverse leakage current

RATINGS AND V-I CHARACTERISTICS CURVES ($T_A=25^{\circ}\text{C}$, unless otherwise noted)

FIG.1:V- I curve characteristics (Uni-directional)

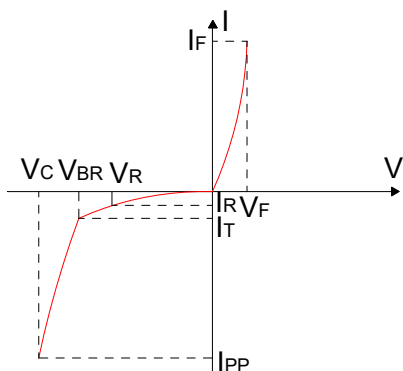

FIG.2:V- I curve characteristics (Bi-directional)

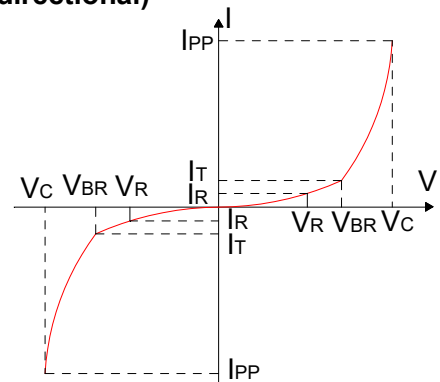

FIG.3: Pulse waveform

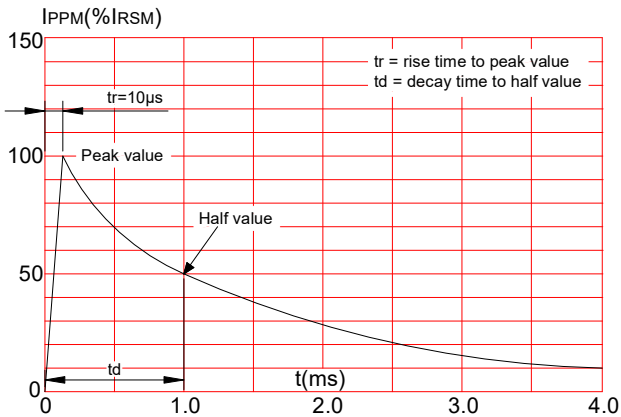

FIG.4: Pulse derating curve

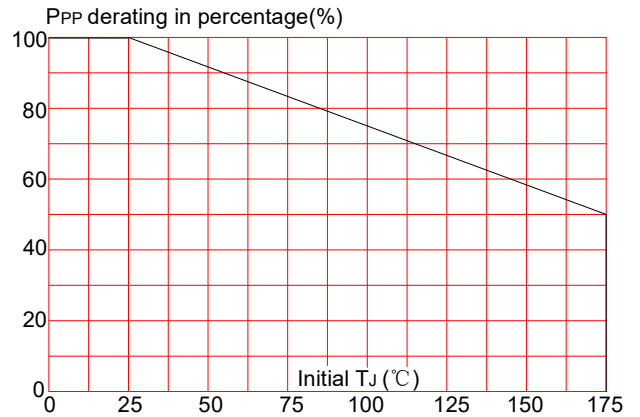
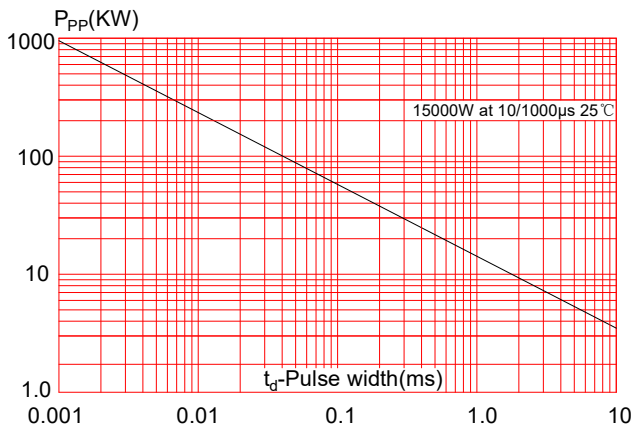
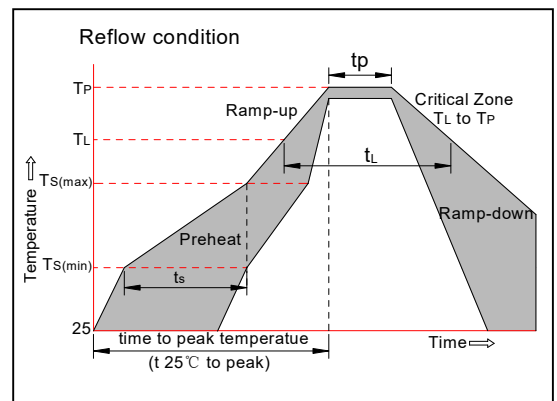

FIG.5: Peak pulse power dissipation vs. pulse width



SOLDERING PARAMETERS

Reflow Condition		Pb-Free assembly (see figure at right)
Pre Heat	-Temperature Min ($T_{s(min)}$)	+150°C
	-Temperature Max($T_{s(max)}$)	+200°C
	-Time (Min to Max) (t_s)	60-180 secs.
Average ramp up rate (Liquidus Temp (T_L) to peak)		3°C/sec. Max
$T_{s(max)}$ to T_L - Ramp-up Rate		3°C/sec. Max
Reflow	-Temperature(T_L)(Liquidus)	+217°C
	-Temperature(t_L)	60-150 secs.
Peak Temp (T_p)		+260(+0/-5)°C
Time within 5°C of actual Peak Temp (t_p)		20-40secs.
Ramp-down Rate		6°C/sec. Max
Time 25°C to Peak Temp (T_p)		8 min. Max
Do not exceed		+260°C



Flow/Wave Soldering(Solder Dipping)	
Peak temperature	265°C
Dipping time	10 sec.
Soldering	1 time

MARKING & ORDERING INFORMATION

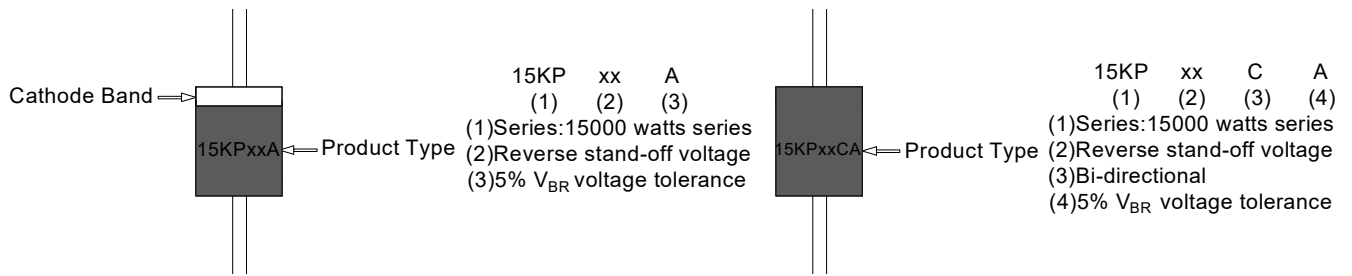

PACKAGE MECHANICAL DATA

Ref.	Dimensions			
	Millimeters		Inches	
	Min.	Max.	Min.	Max.
A	25.40	-	1.000	-
B	8.60	9.40	0.339	0.370
C	1.20	1.40	0.047	0.055
D	8.60	9.10	0.339	0.358

TAPE AND BOX SPECIFICATION-R-6/P-600

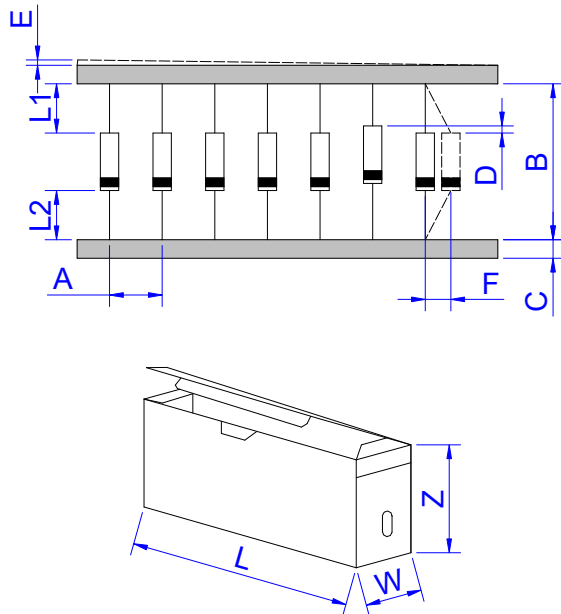

Ref.	Dimensions	
	Millimeters	Inches
A	10.0±0.5	0.394±0.020
B	53.0±1.5	2.087±0.059
C	6.0±0.5	0.236±0.020
D	1.2(MAX)	0.047(MAX)
E	0.8(MAX)	0.031(MAX)
F	1.5(MAX)	0.059(MAX)
L1-L2	1.0(MAX)	0.039(MAX)
W	80±5.0	3.150±0.197
L	250±5.0	9.843±0.197
Z	115±5.0	4.528±0.197

PART No.	UNIT WEIGHT (g/PCS) typ.	PER BOX (PCS)	PER CARTON (PCS)	DESCRIPTION
15KPxxA/CA	3.24	300	3,000	Box

Jiejie products are not designed for, and shall not be used for, any purpose (including, without limitation, automotive, military, aerospace, medical, life-saving, life-sustaining or nuclear facility applications, devices intended for surgical implant into the body, or any other application in which the failure or lack of desired operation of the product may result in personal injury, death, or property damage) other than those expressly set forth in applicable Jiejie product documentation. Warranties granted by Jiejie shall be deemed void for products used for any purpose not expressly set forth in applicable Jiejie documentation. Jiejie shall not be liable for any claims or damages arising out of products used in applications not expressly intended by Jiejie as set forth in applicable Jiejie documentation. The sale and use of Jiejie products is subject to Jiejie terms and conditions of sale, unless otherwise agreed by Jiejie.

Information furnished in this document is believed to be accurate and reliable. However, Jiangsu JieJie Microelectronics Co.,Ltd assumes no responsibility for the consequences of use without consideration for such information nor use beyond it.

Information mentioned in this document is subject to change without notice, apart from that when an agreement is signed, Jiangsu JieJie complies with the agreement.

Products and information provided in this document have no infringement of patents. Jiangsu JieJie assumes no responsibility for any infringement of other rights of third parties which may result from the use of such products and information.

This document is the 2.6th version which is made in 24-June-2022. This document supersedes and replaces all information previously supplied.

 is a registered trademark of Jiangsu JieJie Microelectronics Co.,Ltd.

Copyright ©2022 Jiangsu JieJie Microelectronics Co.,Ltd. Printed All rights reserved.