



## 5KP Series 5000W Transient Voltage Suppressor

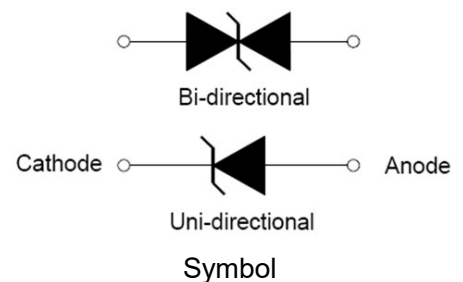
Rev.2.5

### DESCRIPTION:

The 5KP series of high current uni/bi-directional transient suppressors are designed for A.C. line protection and high power DC bus clamping applications. These devices offer uni/bi-directional port protection from 5.0 volts to 250 volts. They provide a clamping voltage lower than the avalanche voltage. Therefore, any voltage rise due to increased current conduction is contained to a minimum, providing the best possible protection level. They can also be connected in series and/or parallel to create very high capacity protection solutions.



R-6/P-600



### FEATURES:

- ✧ Low incremental surge resistance.
- ✧ Excellent clamping capability.
- ✧ Typical  $I_R$  less than  $1\mu A$  above 13V.
- ✧ Color band denoted cathode except bidirectional.
- ✧ High temperature wave soldering:  $265^\circ C/10s$  at terminals.
- ✧ Plastic package has under writers laboratory flammability 94V-0.
- ✧ 5000W peak pulse power capability at 10/1000 $\mu s$  waveform.
- ✧ Meets MSL level 1, per J-STD-020, LF maximum peak of  $260^\circ C$ .
- ✧ Terminal: solder plated, solderable per J-STD-002.
- ✧ Fast response time: typically less than 1.0ps from 0V to  $V_{BR}$  min.
- ✧ UL 497B item recognized. (File No.:E480698).
- ✧ IEC61000-4-2 (ESD)  $\pm 30kV$  (air),  $\pm 30kV$  (contact).

### ABSOLUTE MAXIMUM RATINGS ( $T_A=25^\circ C$ , RH=45%-75%, unless otherwise noted)

Parameter	Symbol	Value	Unit
Operating junction and storage temperature range	$T_J, T_{STG}$	-55 to +175	$^\circ C$
Peak pulse power dissipation at 10/1000 $\mu s$ waveform	$P_{PP}$	5000	W
Steady state power dissipation at $T_L=75^\circ C$	$P_{M(AV)}$	8.0	W
Maximum instantaneous forward voltage at 100A for unidirectional	$V_F$	5.0	V
Peak forward surge current, 8.3ms single half sine-wave for unidirectional only	$I_{FSM}$	400	A

**ABSOLUTE MAXIMUM RATINGS**( $T_A=25^{\circ}\text{C}$ , RH=45%-75%, unless otherwise noted, continued)

Parameter	Symbol	Value	Unit
Typical thermal resistance junction to lead	$R_{\theta JL}$	8.0	$^{\circ}\text{C}/\text{W}$
Typical thermal resistance junction to ambient	$R_{\theta JA}$	40	$^{\circ}\text{C}/\text{W}$

**ELECTRICAL CHARACTERISTICS**( $T_A=25^{\circ}\text{C}$ )

Part Number		$V_R$	$I_R@V_R$	$V_{BR}@I_T$		$I_T$	$V_C@I_{PP}$	$I_{PP}^{\circ}$
Uni-Polar	Bi-Polar	V	max( $\mu\text{A}$ )	min(V)	max(V)	mA	max(V)	A
5KP5.0A	5KP5.0CA	5.0	5000	6.40	7.00	50	9.2	544.0
5KP6.0A	5KP6.0CA	6.0	5000	6.67	7.37	50	10.3	486.0
5KP6.5A	5KP6.5CA	6.5	2000	7.22	7.98	50	11.2	448.0
5KP7.0A	5KP7.0CA	7.0	1000	7.78	8.60	50	12.0	417.0
5KP7.5A	5KP7.5CA	7.5	250	8.33	9.21	5	12.9	388.0
5KP8.0A	5KP8.0CA	8.0	150	8.89	9.83	5	13.6	367.0
5KP8.5A	5KP8.5CA	8.5	50	9.44	10.40	5	14.4	347.0
5KP9.0A	5KP9.0CA	9.0	20	10.00	11.10	5	15.4	325.0
5KP10A	5KP10CA	10.0	15	11.10	12.30	5	17.0	294.0
5KP11A	5KP11CA	11.0	5	12.20	13.50	5	18.2	275.0
5KP12A	5KP12CA	12.0	2	13.30	14.70	5	19.9	252.0
5KP13A	5KP13CA	13.0	2	14.40	15.90	5	21.5	233.0
5KP14A	5KP14CA	14.0	1	15.60	17.20	5	23.2	216.0
5KP15A	5KP15CA	15.0	1	16.70	18.50	5	24.4	205.0
5KP16A	5KP16CA	16.0	1	17.80	19.70	5	26.0	193.0
5KP17A	5KP17CA	17.0	1	18.90	20.90	5	27.6	181.0
5KP18A	5KP18CA	18.0	1	20.00	22.10	5	29.2	172.0
5KP20A	5KP20CA	20.0	1	22.20	24.50	5	32.4	155.0
5KP22A	5KP22CA	22.0	1	24.40	26.90	5	35.5	141.0
5KP24A	5KP24CA	24.0	1	26.70	29.50	5	38.9	129.0
5KP26A	5KP26CA	26.0	1	28.90	31.90	5	42.1	119.0
5KP28A	5KP28CA	28.0	1	31.10	34.40	5	45.4	110.0
5KP30A	5KP30CA	30.0	1	33.30	36.80	5	48.4	103.0
5KP33A	5KP33CA	33.0	1	36.70	40.60	5	53.3	93.9

ELECTRICAL CHARACTERISTICS (T<sub>A</sub>=25°C, continued)

Part Number		V <sub>R</sub>	I <sub>R</sub> @V <sub>R</sub>	V <sub>BR</sub> @I <sub>T</sub>		I <sub>T</sub>	V <sub>C</sub> @I <sub>PP</sub>	I <sub>PP</sub> <sup>①</sup>
Uni-Polar	Bi-Polar	V	max(μA)	min(V)	max(V)	mA	max(V)	A
5KP36A	5KP36CA	36.0	1	40.00	44.20	5	58.1	86.1
5KP40A	5KP40CA	40.0	1	44.40	49.10	5	64.5	77.6
5KP43A	5KP43CA	43.0	1	47.80	52.80	5	69.4	72.1
5KP45A	5KP45CA	45.0	1	50.00	55.30	5	72.7	68.8
5KP48A	5KP48CA	48.0	1	53.30	58.90	5	77.4	64.7
5KP51A	5KP51CA	51.0	1	56.70	62.70	5	82.4	60.7
5KP54A	5KP54CA	54.0	1	60.00	66.30	5	87.1	57.5
5KP58A	5KP58CA	58.0	1	64.40	71.20	5	93.6	53.5
5KP60A	5KP60CA	60.0	1	66.70	73.70	5	96.8	51.7
5KP64A	5KP64CA	64.0	1	71.10	78.60	5	103.0	48.6
5KP70A	5KP70CA	70.0	1	77.80	86.00	5	113.0	44.3
5KP75A	5KP75CA	75.0	1	83.30	92.10	5	121.0	41.4
5KP78A	5KP78CA	78.0	1	86.70	95.80	5	126.0	39.7
5KP85A	5KP85CA	85.0	1	94.40	104.0	5	137.0	36.5
5KP90A	5KP90CA	90.0	1	100.0	111.0	5	146.0	34.3
5KP100A	5KP100CA	100.0	1	111.0	123.0	5	162.0	30.9
5KP110A	5KP110CA	110.0	1	122.0	135.0	5	177.0	28.3
5KP120A	5KP120CA	120.0	1	133.0	147.0	5	193.0	26.0
5KP130A	5KP130CA	130.0	1	144.0	159.0	5	209.0	24.0
5KP150A	5KP150CA	150.0	1	167.0	185.0	5	243.0	20.6
5KP160A	5KP160CA	160.0	1	178.0	197.0	5	259.0	19.3
5KP170A	5KP170CA	170.0	1	189.0	209.0	5	275.0	18.2
5KP180A	5KP180CA	180.0	1	201.0	222.0	5	292.0	17.5
5KP190A	5KP190CA	190.0	1	211.0	233.0	5	310.0	16.5
5KP200A	5KP200CA	200.0	1	224.0	247.0	5	329.2	15.5
5KP210A	5KP210CA	210.0	1	237.0	263.0	5	349.5	14.6
5KP220A	5KP220CA	220.0	1	246.0	272.0	5	371.1	13.7
5KP250A	5KP250CA	250.0	1	277.0	306.0	5	425.0	12.0

① Surge waveform: 10/1000μs

V<sub>R</sub>: Stand-off voltage -- Maximum voltage that can be applied

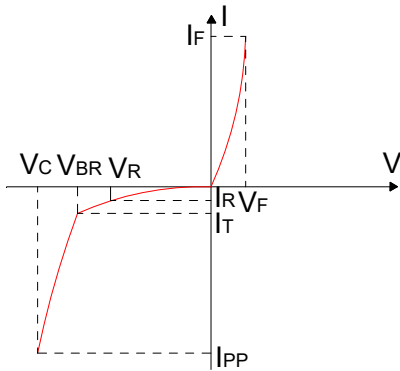
$V_{BR}$ : Breakdown voltage

$V_C$ : Clamping voltage -- Peak voltage measured across the suppressor at a specified  $I_{PP}$

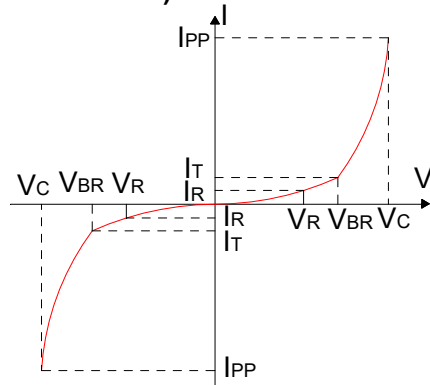
$I_R$ : Reverse leakage current

**RATINGS AND V-I CHARACTERISTICS CURVES** ( $T_A=25^\circ C$ , unless otherwise noted)

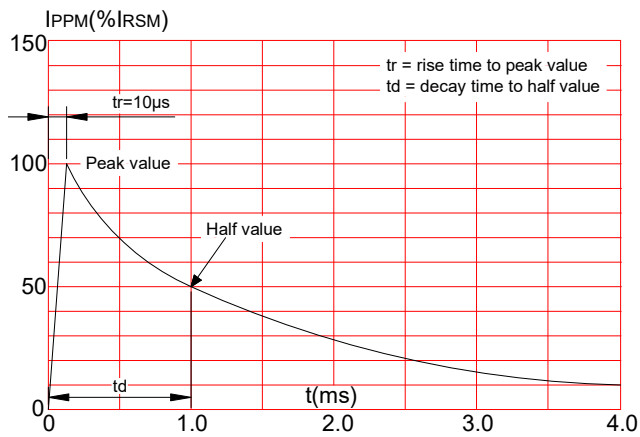
**FIG.1:V- I curve characteristics (Uni-directional)**



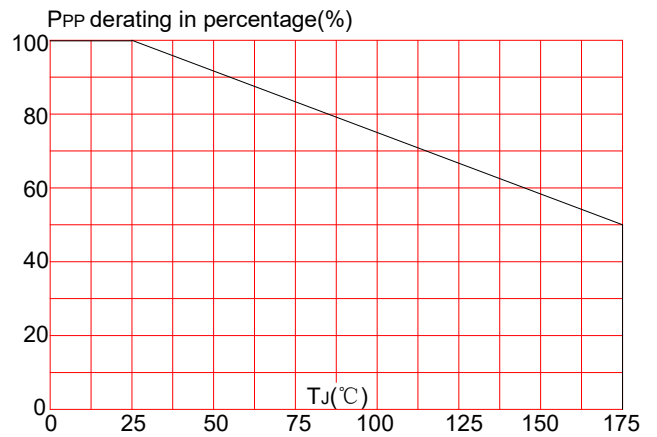
**FIG.2:V- I curve characteristics (Bi-directional)**



**FIG.3: Pulse waveform**

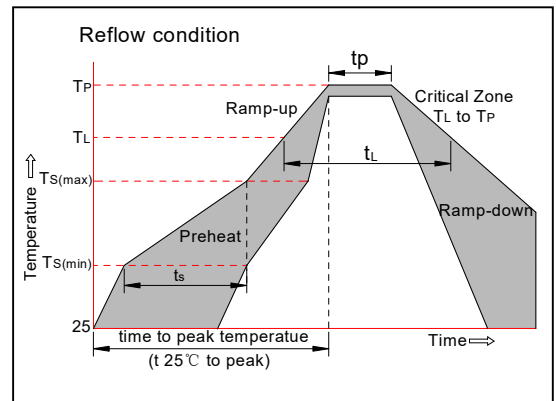


**FIG.4: Pulse derating curve**



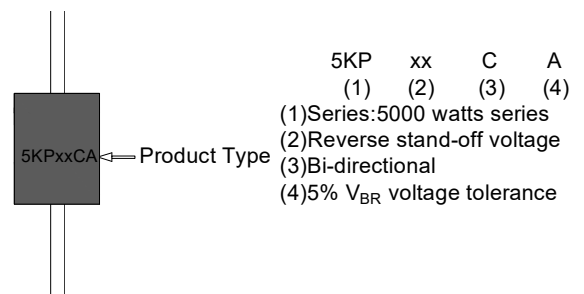
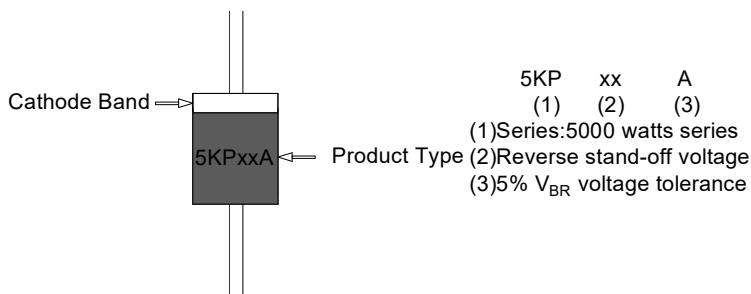
**SOLDERING PARAMETERS**

Reflow Condition		Pb-Free assembly (see figure at right)
Pre Heat	-Temperature Min ( $T_{s(min)}$ )	+150°C
	-Temperature Max( $T_{s(max)}$ )	+200°C
	-Time (Min to Max) ( $t_s$ )	60-180 secs.
Average ramp up rate (Liquidus Temp ( $T_L$ )to peak)		3°C/sec. Max
$T_{s(max)}$ to $T_L$ - Ramp-up Rate		3°C/sec. Max
Reflow	-Temperature( $T_L$ )(Liquidus)	+217°C
	-Temperature( $t_L$ )	60-150 secs.
Peak Temp ( $T_p$ )		+260(+0/-5)°C
Time within 5°C of actual Peak Temp ( $t_p$ )		20-40secs.
Ramp-down Rate		6°C/sec. Max
Time 25°C to Peak Temp ( $T_p$ )		8 min. Max
Do not exceed		+260°C

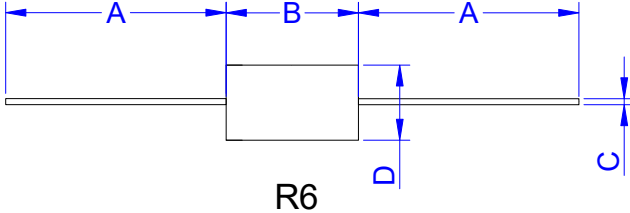


Flow/Wave Soldering(Solder Dipping)	
Peak temperature	265°C
Dipping time	10 sec.
Soldering	1 time

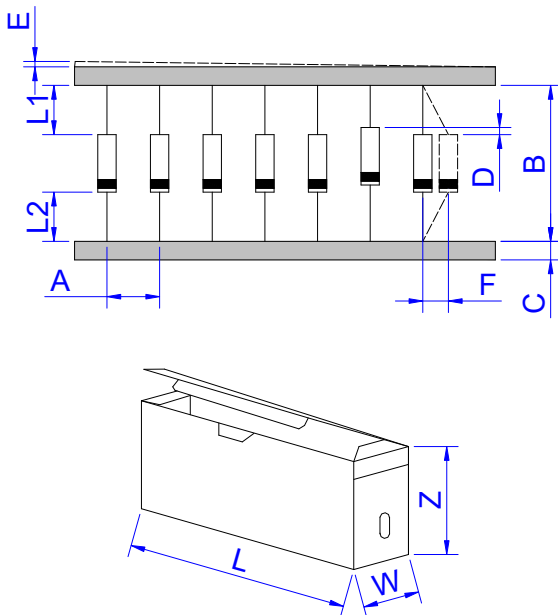
**MARKING & ORDERING INFORMATION**



PACKAGE MECHANICAL DATA

 <p>R6</p>	Ref.	Dimensions			
		Millimeters		Inches	
	Min.	Max.	Min.	Max.	
	A	25.40	-	1.000	-
B	8.60	9.40	0.339	0.370	
C	1.20	1.40	0.047	0.055	
D	8.60	9.10	0.339	0.358	

TAPE AND BOX SPECIFICATION-R-6/P-600



Ref.	Dimensions	
	Millimeters	Inches
A	10.0±0.5	0.394±0.020
B	53.0±1.5	2.087±0.059
C	6.0±0.5	0.236±0.020
D	1.2(MAX)	0.047(MAX)
E	0.8(MAX)	0.031(MAX)
F	1.5(MAX)	0.059(MAX)
L1-L2	1.0(MAX)	0.039(MAX)
W	80±5.0	3.150±0.197
L	250±5.0	9.843±0.197
Z	115±5.0	4.528±0.197

PART No.	UNIT WEIGHT (g/PCS) typ.	PER BOX (PCS)	PER CARTON (PCS)	DESCRIPTION
5KPxxA/CA	2.4	300	3,000	Box


Jiejie products are not designed for, and shall not be used for, any purpose (including, without limitation, automotive, military, aerospace, medical, life-saving, life-sustaining or nuclear facility applications, devices intended for surgical implant into the body, or any other application in which the failure or lack of desired operation of the product may result in personal injury, death, or property damage) other than those expressly set forth in applicable Jiejie product documentation. Warranties granted by Jiejie shall be deemed void for products used for any purpose not expressly set forth in applicable Jiejie documentation. Jiejie shall not be liable for any claims or damages arising out of products used in applications not expressly intended by Jiejie as set forth in applicable Jiejie documentation. The sale and use of Jiejie products is subject to Jiejie terms and conditions of sale, unless otherwise agreed by Jiejie.

Information furnished in this document is believed to be accurate and reliable. However, Jiangsu Jiejie Microelectronics Co.,Ltd assumes no responsibility for the consequences of use without consideration for such information nor use beyond it.

Information mentioned in this document is subject to change without notice, apart from that when an agreement is signed, Jiangsu Jiejie complies with the agreement.

Products and information provided in this document have no infringement of patents. Jiangsu Jiejie assumes no responsibility for any infringement of other rights of third parties which may result from the use of such products and information.

This document is the 2.5th version which is made in 24-June-2022. This document supersedes and replaces all information previously supplied.

 is a registered trademark of Jiangsu Jiejie Microelectronics Co.,Ltd.

Copyright ©2022 Jiangsu Jiejie Microelectronics Co.,Ltd. Printed All rights reserved.