

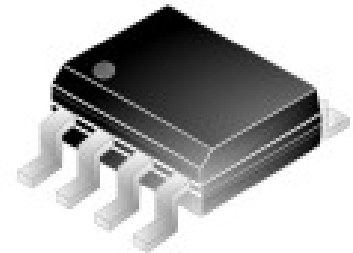

FEATURES

- ◇ 500 Watts peak pulse power per line ($t_P=8/20\mu s$)
- ◇ Bi-directional protection
- ◇ Protects four I/O lines
- ◇ Low leakage current
- ◇ Low operating and clamping voltage
- ◇ Solid-state silicon avalanche technology
- ◇ RoHS compliant



SOP-8

MAIN APPLICATIONS

- ◇ WAN/LAN equipment
- ◇ Multi-mode transceiver protection
- ◇ Instrumentation
- ◇ Microprocessor based equipment
- ◇ Data and I/O lines
- ◇ Serial and parallel ports

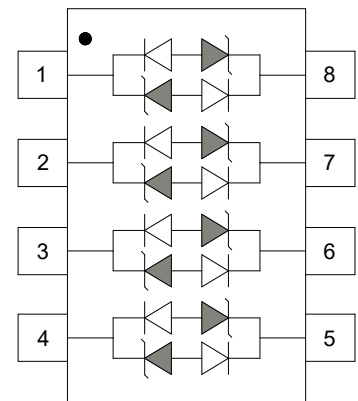

Pin Configuration(Top view)

PROTECTION SOLUTION TO MEET

- ◇ IEC61000-4-2 (ESD) $\pm 15kV$ (air), $\pm 8kV$ (contact)
- ◇ IEC61000-4-4 (EFT) 40A (5/50ns)
- ◇ IEC61000-4-5 (Lightning) 25A (8/20 μs)

MECHANICAL CHARACTERISTICS

- ◇ JEDEC SOP-8 package
- ◇ Molding compound flammability rating : UL 94V-0
- ◇ Quantity per reel : 4,000pcs
- ◇ Lead finish :lead free
- ◇ Marking code :B LC05C-4

ABSOLUTE MAXIMUM RATINGS ($T_A=25^{\circ}\text{C}$, RH=45%-75%, unless otherwise noted)

Parameter	Symbol	Value	Unit
Peak pulse power dissipation at 8/20 μs waveform	P_{PP}	500	W
ESD per IEC 61000-4-2 (Air) ESD per IEC 61000-4-2 (Contact)	V_{ESD}	+/-15 +/-8	kV
Lead soldering temperature	T_L	260 (10 sec.)	$^{\circ}\text{C}$
Operating junction temperature range	T_J	-55 to +125	$^{\circ}\text{C}$
Storage temperature range	T_{STG}	-55 to +150	$^{\circ}\text{C}$

ELECTRICAL CHARACTERISTICS ($T_A=25^{\circ}\text{C}$)

Parameter	Symbol	Conditions	Min	Typ	Max	Unit
Reverse working voltage	V_{RWM}				5	V
Reverse breakdown voltage	V_{BR}	$I_T=1\text{mA}$	6			V
Reverse leakage current	I_R	$V_{RWM}=5\text{V}$			10	μA
Peak pulse current	I_{PP}	$t_p=8/20\mu\text{s}$			25	A
Clamping voltage	V_C	$I_{PP}=1\text{A}$, $t_p=8/20\mu\text{s}$			9.8	V
		$I_{PP}=10\text{A}$, $t_p=8/20\mu\text{s}$		12	15	
		$I_{PP}=25\text{A}$, $t_p=8/20\mu\text{s}$		20	25	
Junction capacitance	C_J	$V_R=0\text{V}$, $f=1\text{MHz}$		1	2	pF

RATINGS AND V-I CHARACTERISTICS CURVES ($T_A=25^{\circ}\text{C}$, unless otherwise noted)

FIG.1:V- I curve characteristics (Bi-directional)

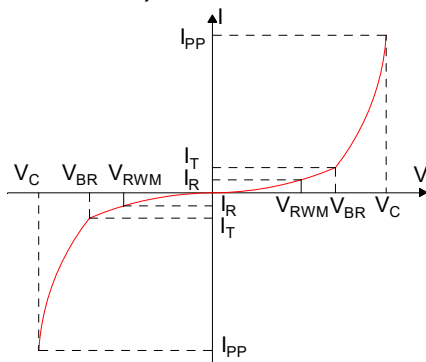

FIG.2: Pulse waveform (8/20 μs)

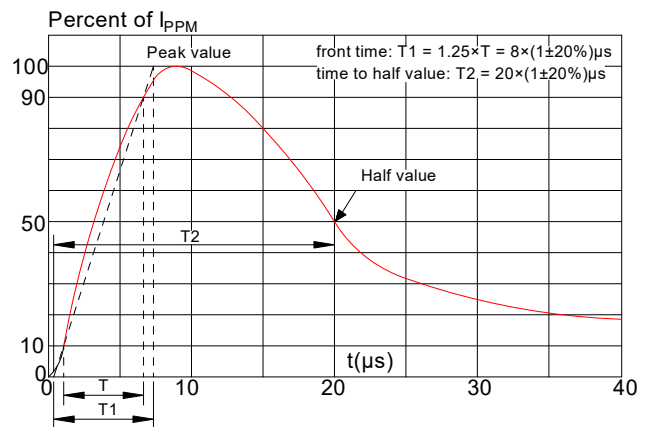

FIG.3: Pulse derating curve

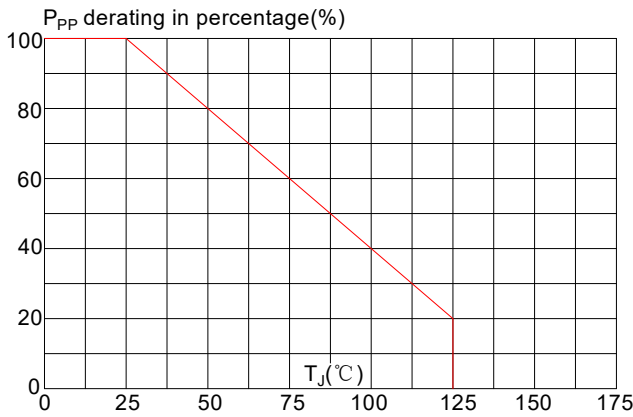
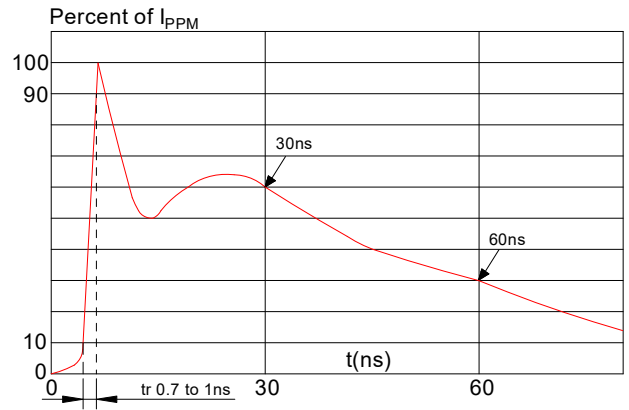
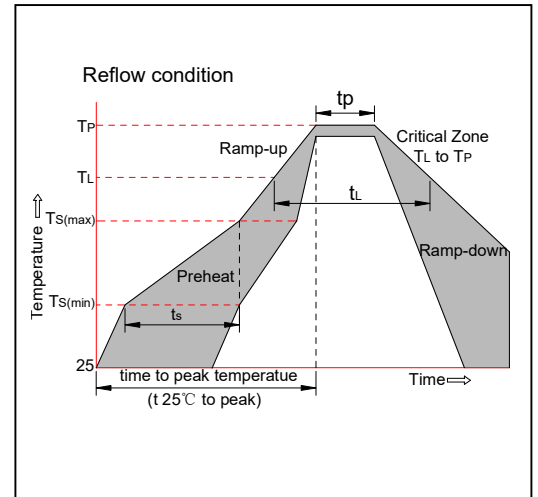

FIG.4: ESD clamping (8kV contact)



SOLDERING PARAMETERS

Reflow Condition		Pb-Free assembly (see figure at right)
Pre Heat	-Temperature Min ($T_{s(min)}$)	+150°C
	-Temperature Max ($T_{s(max)}$)	+200°C
	-Time (Min to Max) (ts)	60-180 secs.
Average ramp up rate (Liquidus Temp (T_L) to peak)		3°C/sec. Max
$T_{s(max)}$ to T_L - Ramp-up Rate		3°C/sec. Max
Reflow	-Temperature (T_L) (Liquidus)	+217°C
	-Temperature (t_L)	60-150 secs.
Peak Temp (T_P)		+260(+0/-5)°C
Time within 5°C of actual Peak Temp (t_p)		20-40secs.
Ramp-down Rate		6°C/sec. Max
Time 25°C to Peak Temp (T_P)		8 min. Max
Do not exceed		+260°C



PACKAGE MECHANICAL DATA

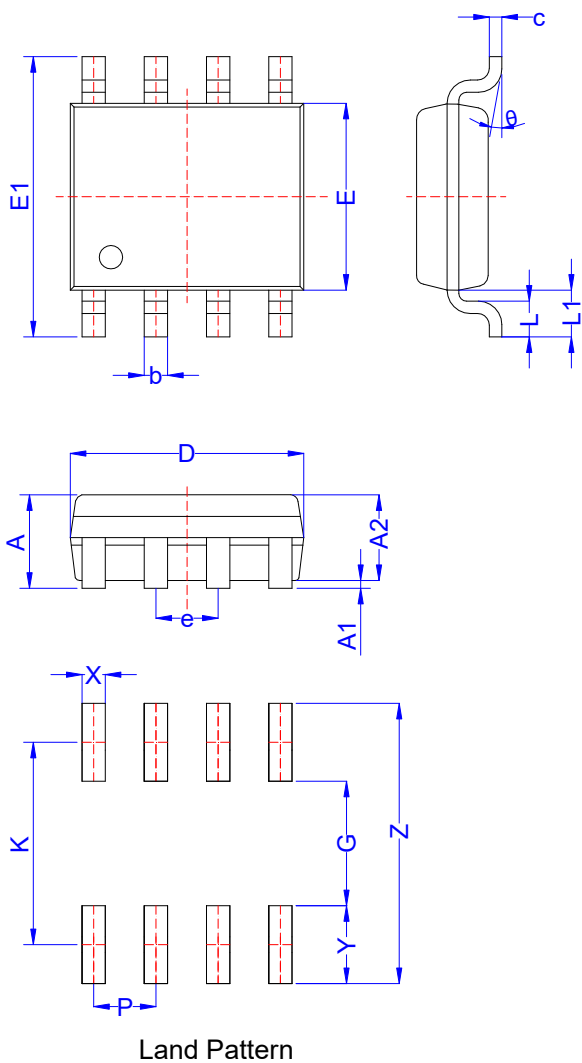

Symbol	Millimeter			Inches		
	Min	Typ	Max	Min	Typ	Max
A	1.35	1.55	1.70	0.053	0.061	0.067
A1	0.04	0.11	0.18	0.002	0.004	0.007
A2	1.30	1.40	1.55	0.051	0.055	0.061
b	0.31	0.41	0.51	0.012	0.016	0.020
c	0.17	0.21	0.25	0.007	0.008	0.010
D	4.65	4.90	5.10	0.183	0.193	0.201
E	3.70	3.90	4.10	0.146	0.154	0.161
E1	5.80	6.00	6.20	0.228	0.236	0.244
e	1.14	1.27	1.40	0.045	0.050	0.055
L	0.40	0.50	0.77	0.016	0.020	0.030
L1	0.825	1.025	1.225	0.032	0.040	0.048
θ	0°	4°	8°	0°	4°	8°
G	3.00			0.118		
K	5.20			0.205		
P	1.27			0.050		
X	0.60			0.024		
Y	2.20			0.087		
Z	7.40			0.291		

TAPE AND REEL SPECIFICATION-SOP-8

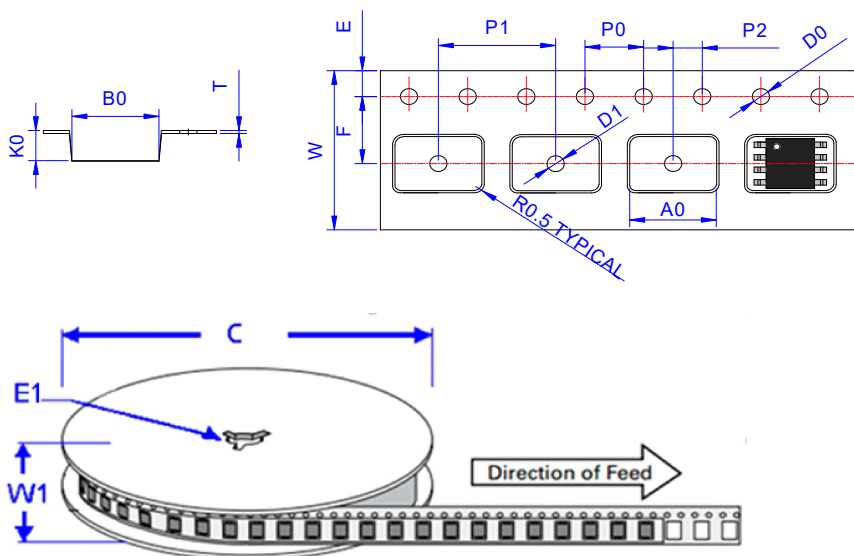

Symbol	Millimeters	Inches
	Typ.	Typ.
A0	6.40	0.252
B0	5.30	0.209
C	330	13.0
D0	1.50	0.059
D1	1.50	0.059
E1	13.30	0.524
E	1.75	0.069
F	5.50	0.217
K0	2.10	0.083
P0	4.00	0.157
P1	8.00	0.315
P2	2.00	0.079
T	0.24	0.009
W	12.00	0.472
W1	15.70	0.618

PART No.	PACKAGE TYPE	QUANTITY(PCS) REEL	DESCRIPTION
JEB05LCK4P	SOP-8	4,000	13 inch reel pack

MARKING CODE

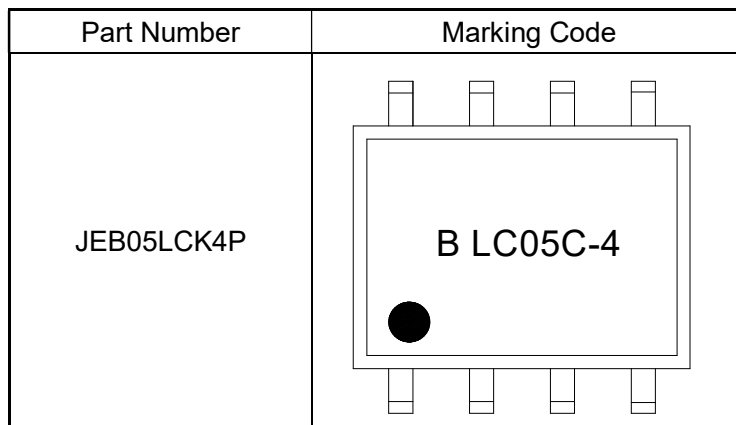

JieJie products are not designed for, and shall not be used for, any purpose (including, without limitation, automotive, military, aerospace, medical, life-saving, life-sustaining or nuclear facility applications, devices intended for surgical implant into the body, or any other application in which the failure or lack of desired operation of the product may result in personal injury, death, or property damage) other than those expressly set forth in applicable JieJie product documentation. Warranties granted by JieJie shall be deemed void for products used for any purpose not expressly set forth in applicable JieJie documentation. JieJie shall not be liable for any claims or damages arising out of products used in applications not expressly intended by JieJie as set forth in applicable JieJie documentation. The sale and use of JieJie products is subject to JieJie terms and conditions of sale, unless otherwise agreed by JieJie.

Information furnished in this document is believed to be accurate and reliable. However, Jiangsu JieJie Microelectronics Co., Ltd. assumes no responsibility for the consequences of use without consideration for such information nor use beyond it.

Information mentioned in this document is subject to change without notice, apart from that when an agreement is signed, Jiangsu JieJie complies with the agreement.

Products and information provided in this document have no infringement of patents. Jiangsu JieJie assumes no responsibility for any infringement of other rights of third parties which may result from the use of such products and information.

This document is the 1.5th version which is made in 14-Dec.-2022. This document supersedes and replaces all information previously supplied.

 is a registered trademark of Jiangsu JieJie Microelectronics Co., Ltd.

Copyright ©2022 Jiangsu JieJie Microelectronics Co., Ltd. Printed All rights reserved.