



P8S Series 8000W Transient Voltage Suppressor

Rev.2.4

DESCRIPTION:

The P8S series of high current uni/bi-directional transient suppressors are designed for A.C. line protection and high power DC bus clamping applications. These devices offer uni/bi-directional port protection from 20 volts to 43 volts. They provide a clamping voltage lower than the avalanche voltage. Therefore, any voltage rise due to increased current conduction is contained to a minimum, providing the best possible protection level. They can also be connected in series and/or parallel to create very high capacity protection solutions.

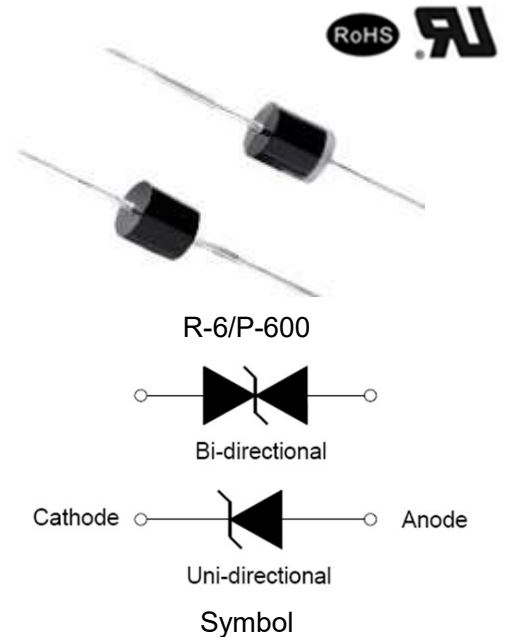

FEATURES:

- ✧ Low incremental surge resistance.
- ✧ Excellent clamping capability.
- ✧ Typical I_R less than $5\mu A$.
- ✧ Color band denoted cathode except bidirectional.
- ✧ High temperature wave soldering: $265^\circ C/10s$ at terminals.
- ✧ Plastic package has under writers laboratory flammability 94V-0.
- ✧ 8000W peak pulse power capability at 10/1000 μs waveform.
- ✧ Meets MSL level 1, per J-STD-020, LF maximum peak of $260^\circ C$.
- ✧ Terminal: solder plated, solderable per J-STD-002.
- ✧ Fast response time: typically less than 1.0ps from 0V to V_{BR} min.
- ✧ UL 497B item recognized. (File No.:E480698).
- ✧ IEC61000-4-2 (ESD) $\pm 30kV$ (air), $\pm 30kV$ (contact).

ABSOLUTE MAXIMUM RATINGS ($T_A=25^\circ C$, RH=45%-75%, unless otherwise noted)

Parameter	Symbol	Value	Unit
Operating junction and storage temperature range	T_J, T_{STG}	-55 to +175	$^\circ C$
Peak pulse power dissipation at 10/1000 μs waveform	P_{PP}	8000	W
Steady state power dissipation at $T_L=75^\circ C$	$P_{M(AV)}$	8	W
Maximum instantaneous forward voltage at 100A for unidirectional	V_F	5.0	V
Peak forward surge current, 8.3ms single half sine-wave for unidirectional only	I_{FSM}	400	A

ABSOLUTE MAXIMUM RATINGS ($T_A=25^{\circ}\text{C}$, RH=45%-75%, unless otherwise noted, continued)

Parameter	Symbol	Value	Unit
Typical thermal resistance junction to lead	$R_{\theta JL}$	8.0	$^{\circ}\text{C}/\text{W}$
Typical thermal resistance junction to ambient	$R_{\theta JA}$	40	$^{\circ}\text{C}/\text{W}$

ELECTRICAL CHARACTERISTICS ($T_A=25^{\circ}\text{C}$)

Part Number		V_R	$I_R@V_R$	$V_{BR}@I_T$		I_T	$V_C@I_{PP}$	$I_{PP}^{\text{①}}$
Uni-Polar	Bi-Polar	V	max(μA)	min(V)	max(V)	mA	max(V)	A
P8S20A	P8S20CA	20	5	22.2	24.5	5	32.4	246.9
P8S22A	P8S22CA	22	5	24.4	26.9	5	35.5	225.3
P8S24A	P8S24CA	24	5	26.7	29.5	5	38.9	205.6
P8S26A	P8S26CA	26	5	28.9	31.9	5	42.1	190.1
P8S28A	P8S28CA	28	5	31.1	34.4	5	45.4	176.2
P8S30A	P8S30CA	30	5	33.3	36.8	5	48.4	165.3
P8S33A	P8S33CA	33	5	36.7	40.6	5	53.3	150.1
P8S36A	P8S36CA	36	5	40.0	44.2	5	58.1	137.7
P8S40A	P8S40CA	40	5	44.4	49.1	5	64.5	124.1
P8S43A	P8S43CA	43	5	47.8	52.8	5	69.4	115.3

① Surge waveform: 10/1000 μs

V_R : Stand-off voltage -- Maximum voltage that can be applied

V_{BR} : Breakdown voltage

V_C : Clamping voltage -- Peak voltage measured across the suppressor at a specified I_{PP}

I_R : Reverse leakage current

RATINGS AND V-I CHARACTERISTICS CURVES (T_A=25°C, unless otherwise noted)

FIG.1:V- I curve characteristics (Uni-directional)

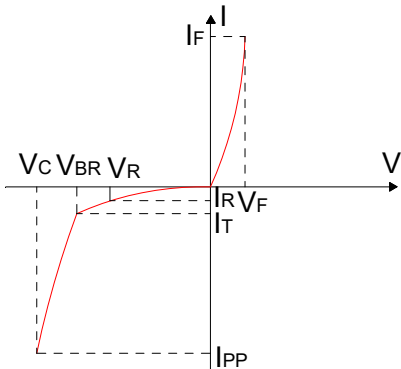

FIG.2:V- I curve characteristics (Bi-directional)

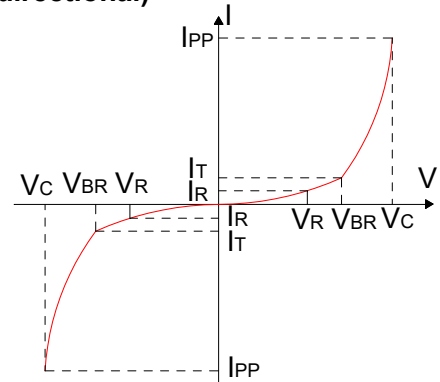

FIG.3: Pulse waveform

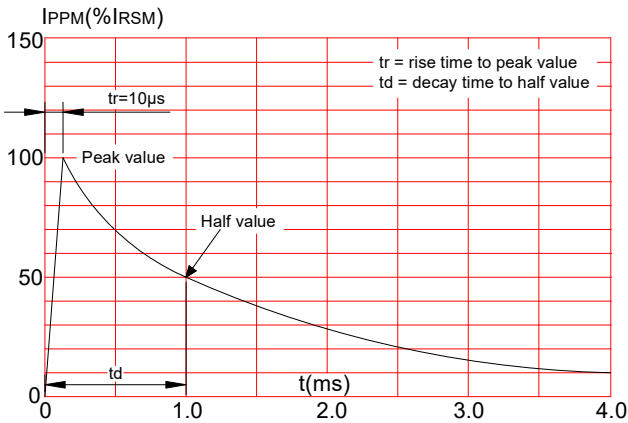
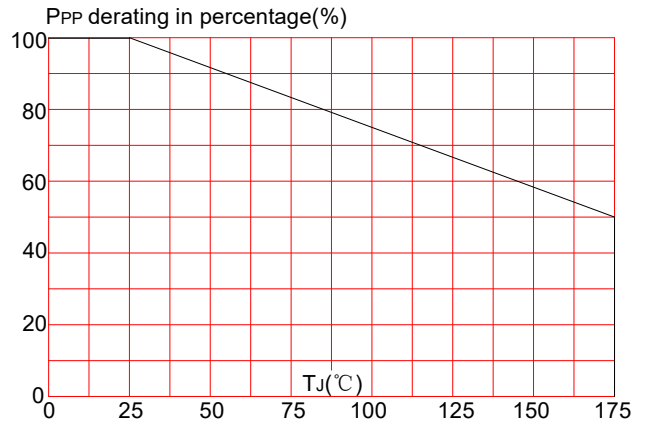
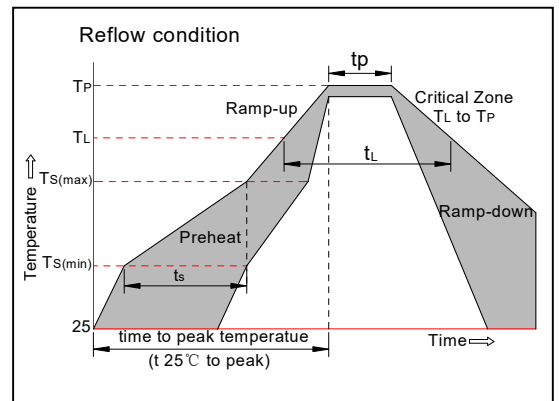

FIG.4: Pulse derating curve



SOLDERING PARAMETERS

Reflow Condition		Pb-Free assembly (see figure at right)
Pre Heat	-Temperature Min (T _{s(min)})	+150°C
	-Temperature Max(T _{s(max)})	+200°C
	-Time (Min to Max) (t _s)	60-180 secs.
Average ramp up rate (Liquidus Temp (T _L)to peak)		3°C/sec. Max
T _{s(max)} to T _L - Ramp-up Rate		3°C/sec. Max
Reflow	-Temperature(T _L)(Liquidus)	+217°C
	-Temperature(t _L)	60-150 secs.
Peak Temp (T _p)		+260(+0/-5)°C
Time within 5°C of actual Peak Temp (t _p)		20-40secs.
Ramp-down Rate		6°C/sec. Max
Time 25°C to Peak Temp (T _p)		8 min. Max
Do not exceed		+260°C



Flow/Wave Soldering(Solder Dipping)	
Peak temperature	265°C
Dipping time	10 sec.
Soldering	1 time

MARKING & ORDERING INFORMATION

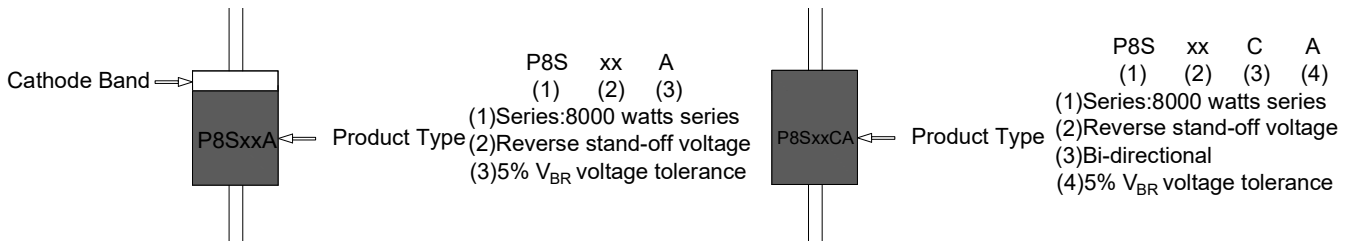

PACKAGE MECHANICAL DATA

Ref.	Dimensions			
	Millimeters		Inches	
	Min.	Max.	Min.	Max.
A	25.40	-	1.000	-
B	8.60	9.40	0.339	0.370
C	1.20	1.40	0.047	0.055
D	8.60	9.10	0.339	0.358

TAPE AND BOX SPECIFICATION-R-6/P-600

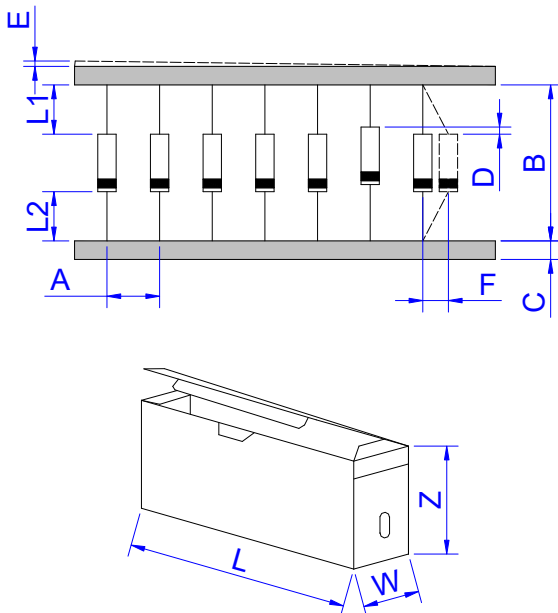

Ref.	Dimensions	
	Millimeters	Inches
A	10.0±0.5	0.394±0.020
B	53.0±1.5	2.087±0.059
C	6.0±0.5	0.236±0.020
D	1.2(MAX)	0.047(MAX)
E	0.8(MAX)	0.031(MAX)
F	1.5(MAX)	0.059(MAX)
L1-L2	1.0(MAX)	0.039(MAX)
W	80±5.0	3.150±0.197
L	250±5.0	9.843±0.197
Z	115±5.0	4.528±0.197

PART No.	UNIT WEIGHT (g/PCS) typ.	PER BOX (PCS)	PER CARTON (PCS)	DESCRIPTION
P8SxxA/CA	2.5	300	3,000	Box

Jiejie products are not designed for, and shall not be used for, any purpose (including, without limitation, automotive, military, aerospace, medical, life-saving, life-sustaining or nuclear facility applications, devices intended for surgical implant into the body, or any other application in which the failure or lack of desired operation of the product may result in personal injury, death, or property damage) other than those expressly set forth in applicable Jiejie product documentation. Warranties granted by Jiejie shall be deemed void for products used for any purpose not expressly set forth in applicable Jiejie documentation. Jiejie shall not be liable for any claims or damages arising out of products used in applications not expressly intended by Jiejie as set forth in applicable Jiejie documentation. The sale and use of Jiejie products is subject to Jiejie terms and conditions of sale, unless otherwise agreed by Jiejie.

Information furnished in this document is believed to be accurate and reliable. However, Jiangsu JieJie Microelectronics Co.,Ltd assumes no responsibility for the consequences of use without consideration for such information nor use beyond it.

Information mentioned in this document is subject to change without notice, apart from that when an agreement is signed, Jiangsu JieJie complies with the agreement.

Products and information provided in this document have no infringement of patents. Jiangsu JieJie assumes no responsibility for any infringement of other rights of third parties which may result from the use of such products and information.

This document is the 2.4th version which is made in 24-June-2022. This document supersedes and replaces all information previously supplied.

 is a registered trademark of Jiangsu JieJie Microelectronics Co.,Ltd.

Copyright ©2022 Jiangsu JieJie Microelectronics Co.,Ltd. Printed All rights reserved.