

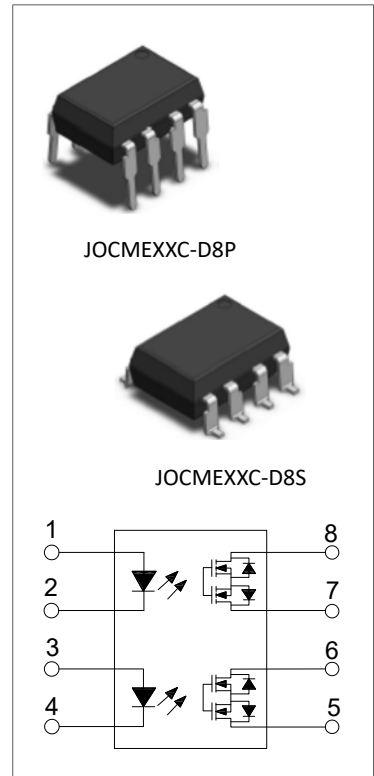

### DESCRIPTION:

The products are 8-pin optical relays. The device consists of an AlGaAs infrared emitting diode input stage optically coupled to a high-voltage output detector circuit in a plastic DIP8 package with different lead forming options. The detector consists of a high-speed photovoltaic diode array and driver circuitry. The products are widely used in isolation in high-speed inspection machines, telephones equipment and computers.



### MAIN FEATURES

- High isolation 5000 Vrms
- Operating temperature range -40°C to 110°C
- REACH & RoHS compliance
- HBM: H3A; MM: M4; CDM: C3
- CQC approved
- VDE approved
- UL approved

### ABSOLUTE MAXIMUM RATINGS (Temperature=25°C)

Parameter		Symbol	Value	Unit
Input	Forward Current	$I_F$	50	mA
	Peak Forward Current	$I_{FP}$	1 <sup>①</sup>	A
	Reverse Voltage	$V_R$	6	V
	Input Power Dissipation	$P_D$	75	mW
Output	Load Voltage	JOCME35C	60	V
		JOCME74C	400	
	Continuous load current	JOCME35C	0.18	A
		JOCME74C	0.1	
Output Power Dissipation	$P_O$	800	mW	
Total Power Dissipation		$P_{tot}$	875	mW
Isolation Voltage		$V_{iso}$	5000 <sup>②</sup>	Vrms
Operating Temperature		$T_{opr}$	-40~110	°C
Junction Temperature		$T_j$	125	°C
Storage Temperature		$T_{stg}$	-40~125	°C

Soldering Temperature	$T_{sol}$	260	°C
-----------------------	-----------	-----	----

**NOTE1** : 100μs pulse, 100Hz frequency

**NOTE2** : AC for 1minute, R.H.=40~60%

**ELECTRICAL CHARACTERISTICS** (Temperature=25°C)

Parameter		Symbol	Condition	Min.	Typ.	Max.	Unit	
Input	Forward Voltage	$V_F$	$I_F=10mA$	-	1.2	1.5	V	
	Reverse Current	$I_R$	$V_R=6V$	-	-	1	μA	
	Action Current	$I_{F(ON)}$	$I_L=I_{L(MAX)}$	-	0.5	-	mA	
	Reset Current	$I_{F(OFF)}$	$I_L=I_{L(MAX)}$	-	2.5	5	mA	
Output	On Resistance	JOCME35C	$I_F=5mA$ $I_L=Max.$ Within 1s on time	-	-	8	Ω	
		JOCME74C		-	-	25		
	Off State Leakage Current	$I_{Leak}$	$I_F=0mA,$ $V_L=Max.$	-	-	1	μA	
Switching Characteristics	Isolation Resistance	$R_{ISO}$	DC500V 40~60%R.H.	$10^{12}$	-	-	Ω	
	Floating Capacitance	$C_{IO}$	$V=0, f=1MHz$	-	0.8	1.5	pF	
	Turn On Time	JOCME35C	$t_{on}$	$I_F=5mA,$ $I_L=Max.$	-	0.5	1	ms
		JOCME74C			-	0.5	1	
	Turn Off Time	JOCME35C	$t_{off}$	$I_F=5mA,$ $I_L=Max.$	-	0.2	0.5	ms
JOCME74C		-			0.2	0.5		

**ORDERING INFORMATION**

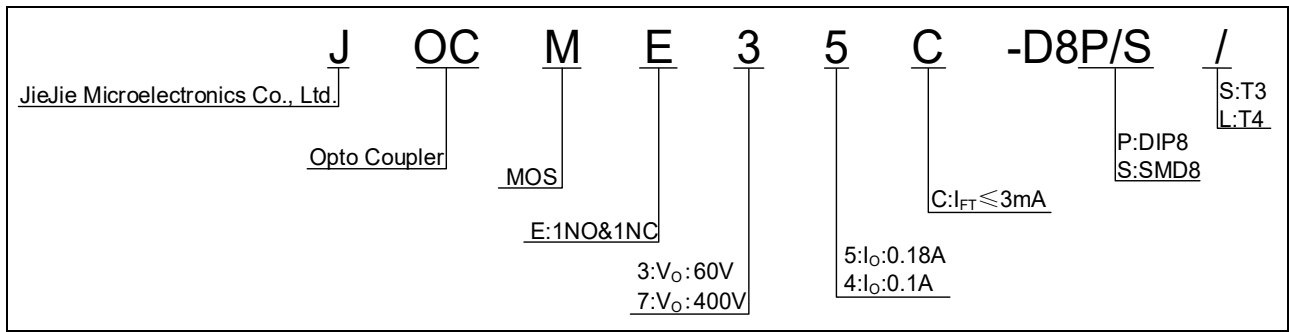

Packing Quantity	
Option	Quantity
DIP	50 Units/Tube
SMD	1200 Units/Reel

**MARKING**

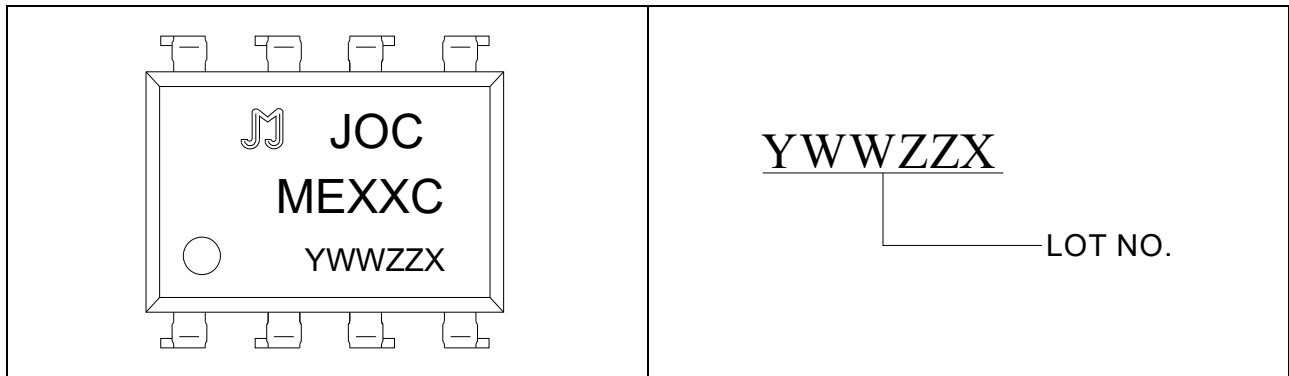

Characteristics Curves

FIG.1: LED Dropout Voltage vs. Ambient Temperature

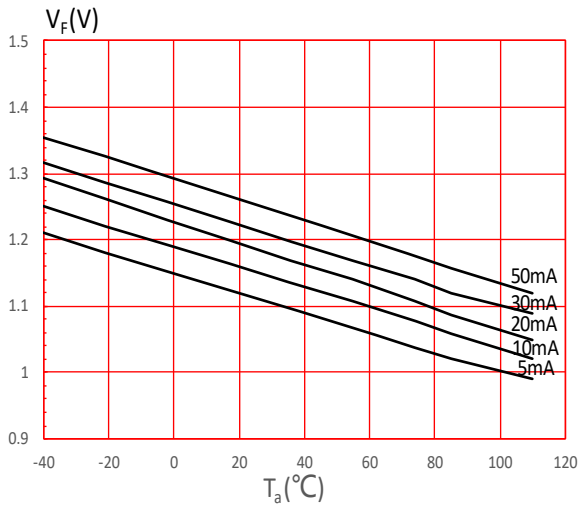

FIG.2: Output Current vs. Output Voltage

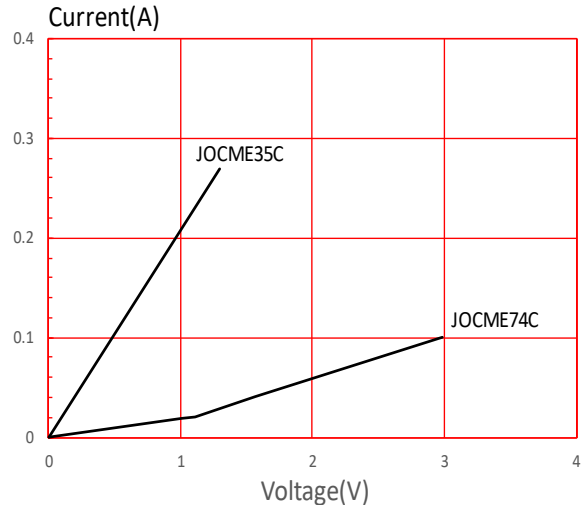

FIG.3: On Resistance vs. Ambient Temperature

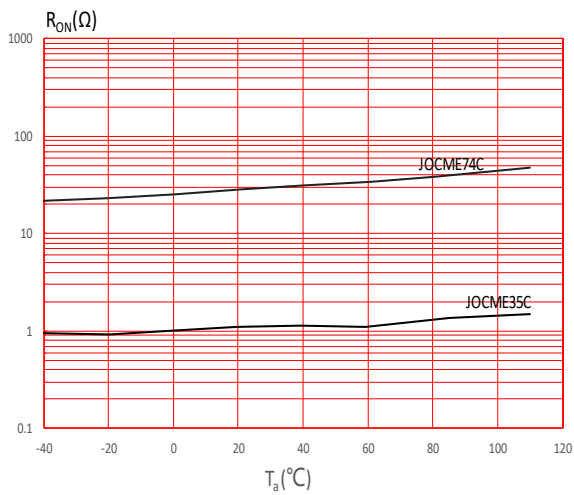

FIG.4: Load Current vs. Ambient Temperature

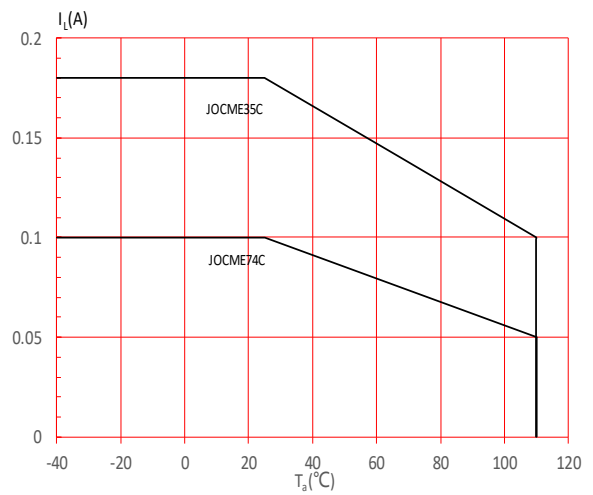

FIG.5: LED Operate Current vs. Ambient Temperature

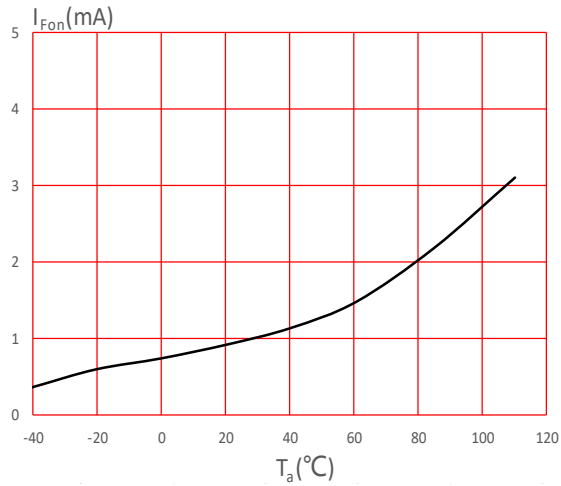

FIG.6: LED Turn Off Current vs. Ambient Temperature

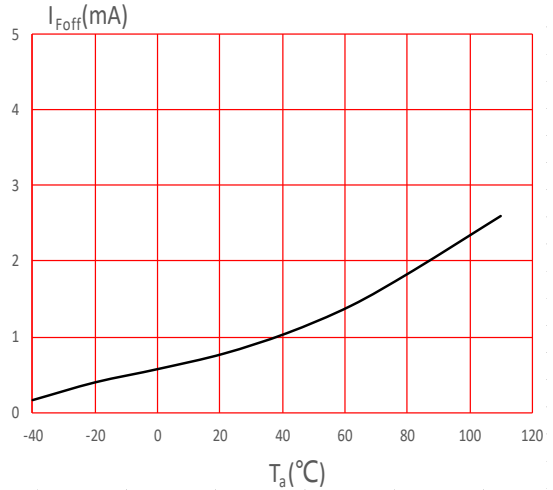

FIG.7: Turn On Time vs. Ambient Temperature

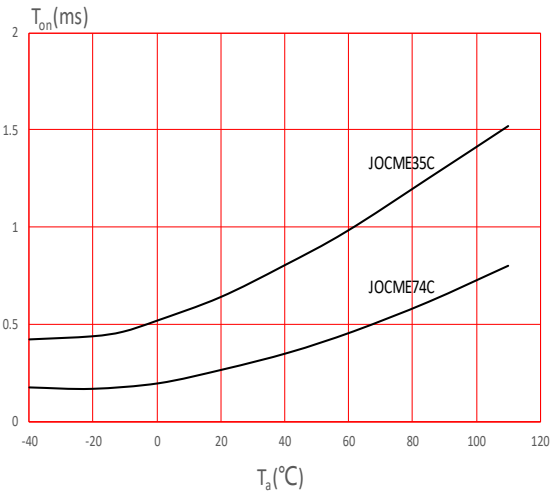

FIG.8: Turn Off Time vs. Ambient Temperature

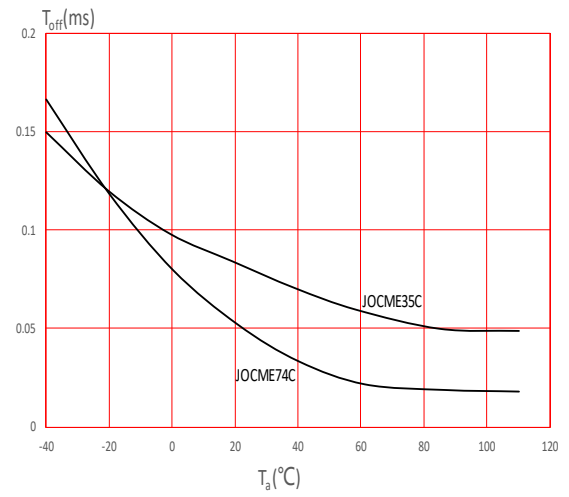

FIG.9: Turn On Time vs. LED Forward Current

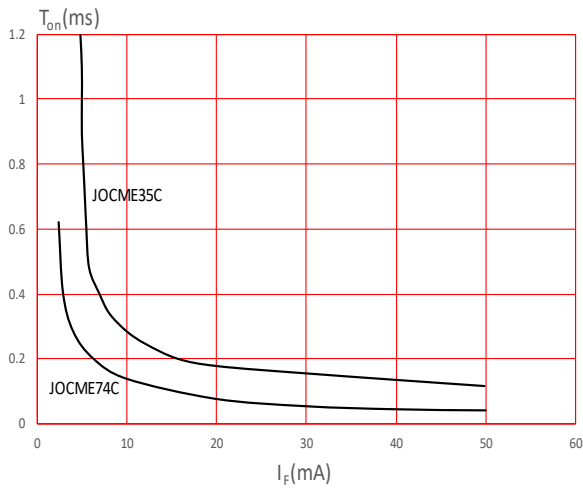

FIG.10: Turn Off Time vs. LED Forward Current

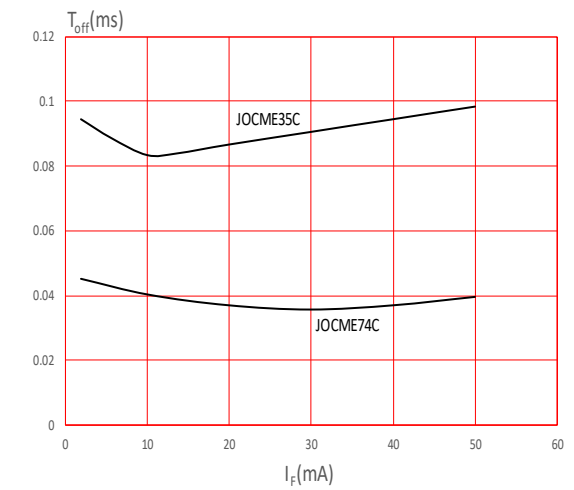

FIG.11: Off State Leakage Current vs. Load Voltage

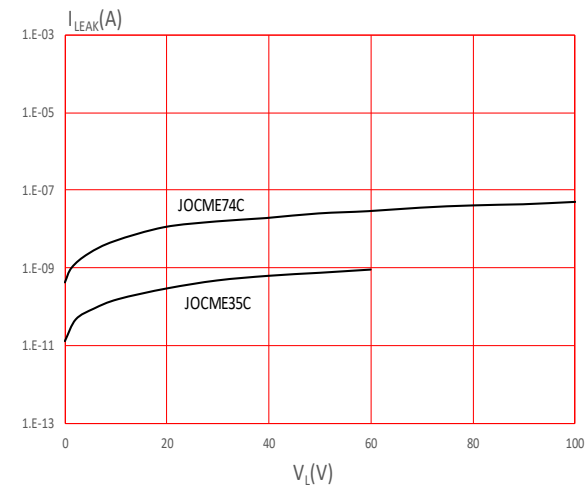
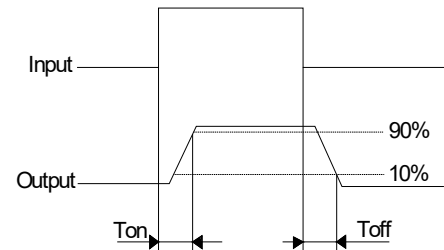
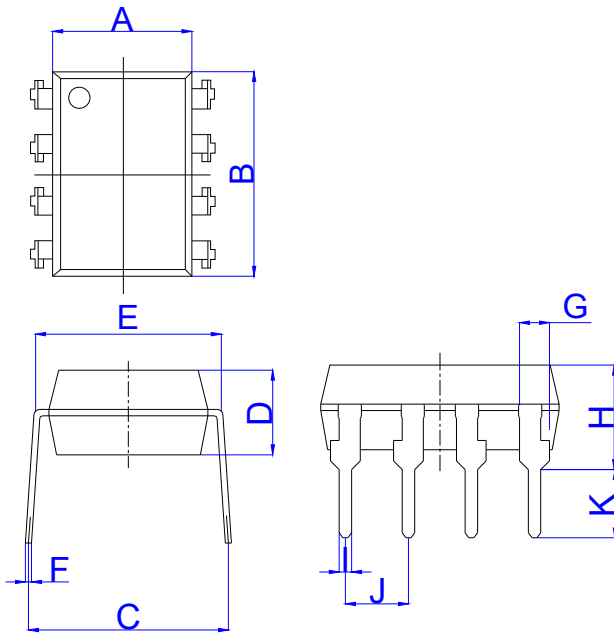

Fig.12: Turn on/Turn off time



Package Dimension (Unit: mm)

Standard DIP Type:



Ref.	Dimensions					
	Millimeters			Inches		
	Min.	Typ.	Max.	Min.	Typ.	Max.
A	6.20		6.60	0.244		0.260
B	9.40		9.80	0.370		0.386
C	7.15		8.95	0.281		0.352
D	3.20		3.60	0.126		0.142
E	7.32		7.92	0.288		0.312
F	0.15		0.35	0.006		0.014
G	0.90		1.50	0.035		0.059
H	3.90		4.50	0.154		0.177
I	0.40		0.60	0.016		0.024
J	2.29		2.79	0.090		0.110
K	2.24		3.24	0.088		0.128

Option SMD Type:

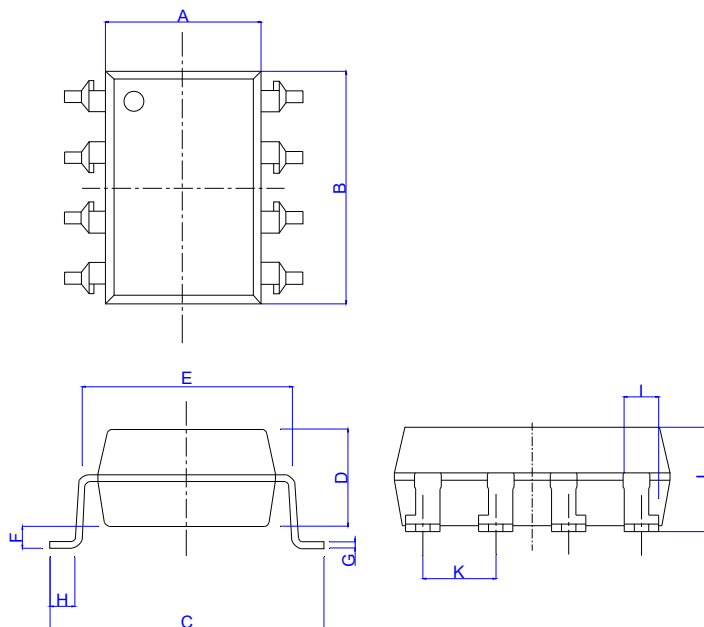

Ref.	Dimensions					
	Millimeters			Inches		
	Min.	Typ.	Max.	Min.	Typ.	Max.
A	6.20		6.60	0.244		0.260
B	9.40		9.80	0.370		0.386
C	9.50		10.50	0.374		0.413
D	3.20		3.60	0.126		0.142
E	7.32		7.92	0.288		0.312
F	0.05		0.35	0.002		0.014
G	0.16		0.36	0.006		0.014
H	0.60		1.40	0.024		0.055
I	0.90		1.50	0.035		0.059
J	3.30		3.90	0.130		0.154
K	2.29		2.79	0.090		0.110

**RECOMMENDED SOLDER MASK (Dimensions in mm unless otherwise stated)**

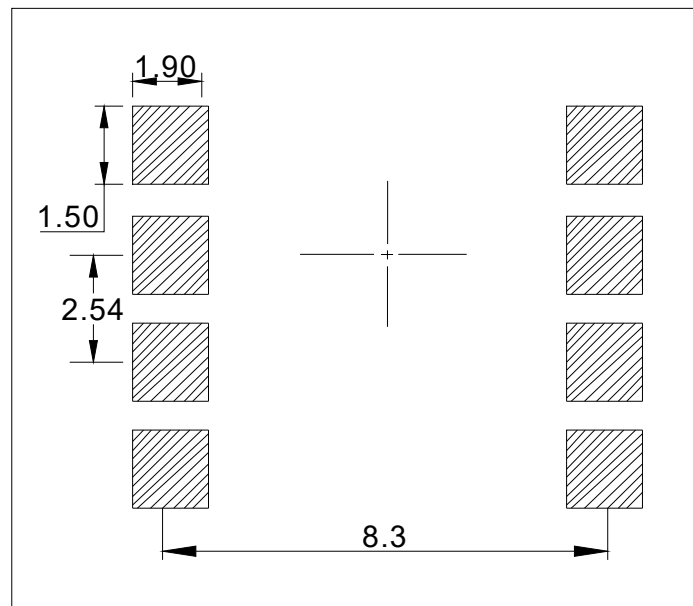

**CARRIER TAPE SPECIFICATIONS (Dimensions in mm unless otherwise stated)**

Option S/L

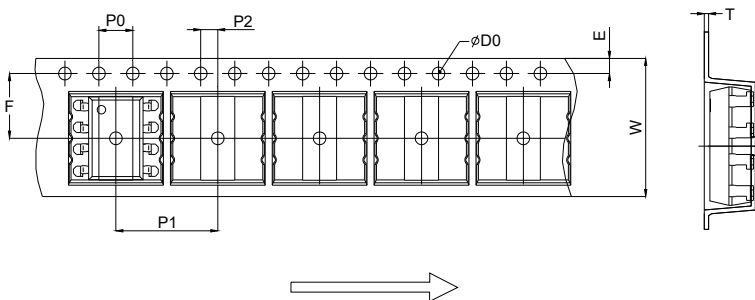

Ref.	Dimensions					
	Millimeters			Inches		
	Min.	Typ.	Max.	Min.	Typ.	Max.
D0		1.50	1.60		0.059	0.063
P0	3.90	4.00	4.10	0.154	0.157	0.161
P1	11.90	12.00	12.10	0.469	0.472	0.476
P2	1.90	2.00	2.10	0.075	0.079	0.083
E	1.65	1.75	1.85	0.065	0.069	0.073
F	7.40	7.50	7.60	0.291	0.295	0.299
T	0.35	0.40	0.45	0.014	0.016	0.018
W	15.90	16.00	16.20	0.626	0.630	0.638

REFLOW INFORMATION

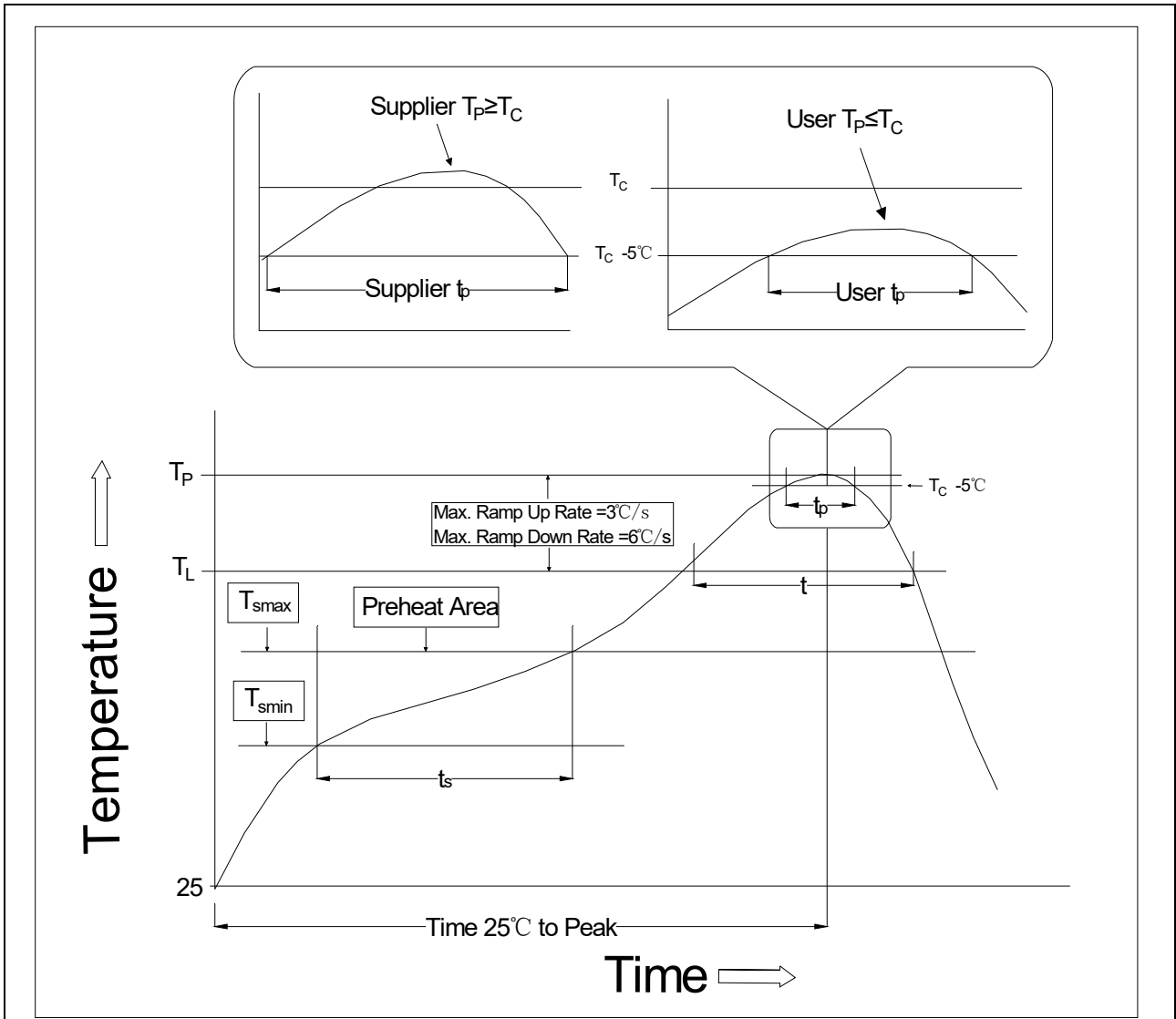

Profile Feature	Sn-Pb Assembly Profile	Pb-Free Assembly Profile
Temperature Min. (T <sub>smin</sub> )	100	150°C
Temperature Max. (T <sub>smax</sub> )	150	200°C
Time (t <sub>s</sub> ) from (T <sub>smin</sub> to T <sub>smax</sub> )	60-120 seconds	60-120 seconds
Ramp-up Rate (t <sub>L</sub> to t <sub>P</sub> )	3°C/second max.	3°C/second max.
Liquidus Temperature (T <sub>L</sub> )	183°C	217°C
Time (t <sub>L</sub> ) Maintained Above (T <sub>L</sub> )	60-150 seconds	60-150 seconds
Peak Body Package Temperature	235°C+0°C/-5°C	260°C+0°C/-5°C
Time (t <sub>P</sub> ) within 5°C of 260°C	20 seconds	30 seconds
Ramp-down Rate (T <sub>P</sub> to T <sub>L</sub> )	6°C/second max.	6°C/second max.
Time 25°C to Peak Temperature	6 minutes max.	8 minutes max.

**WAVE SOLDERING**

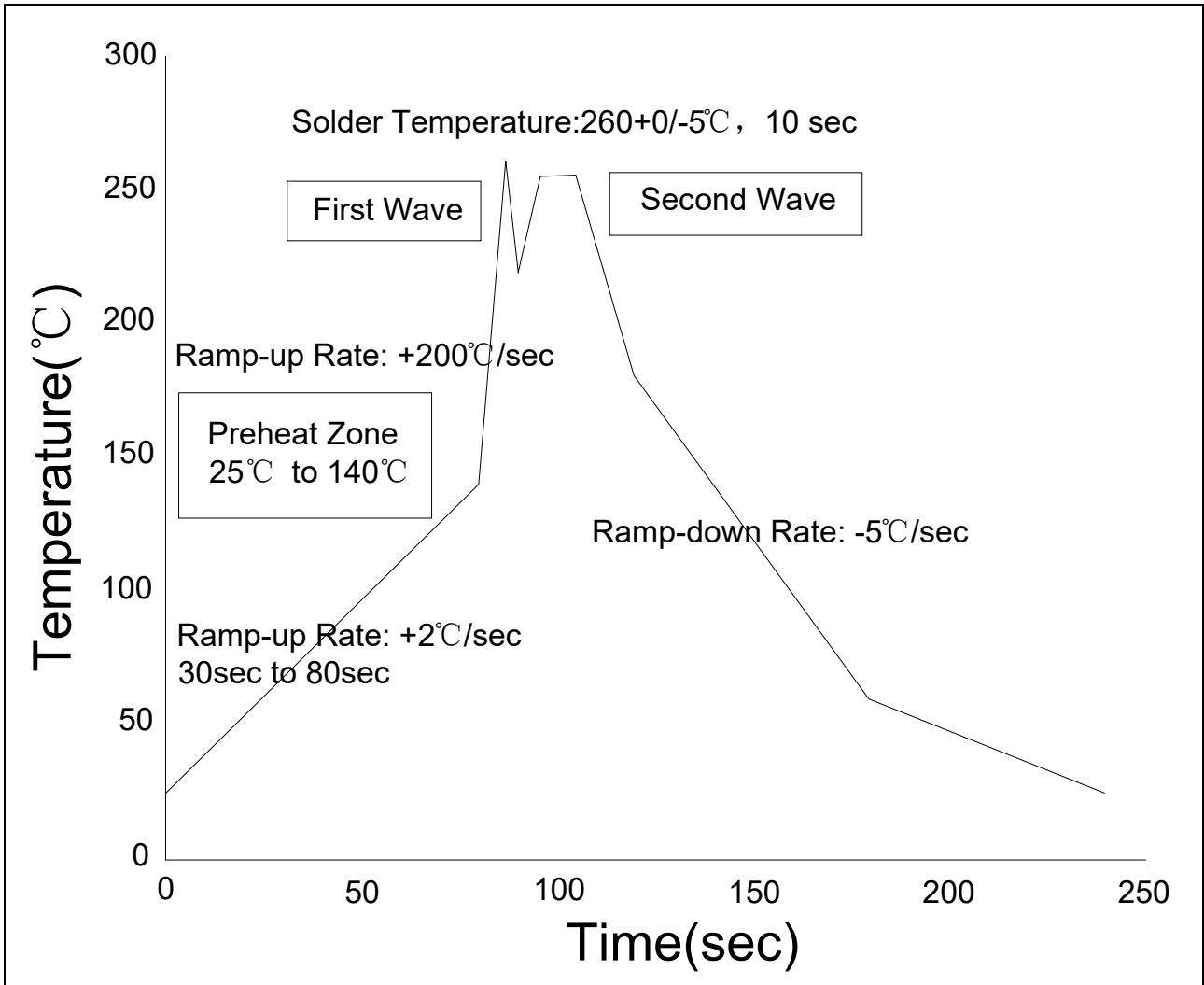

**HAND SOLDERING BY SOLDERING IRON**

Soldering Temperature	$360 \pm 5^{\circ}\text{C}$
Soldering Time	3s max.

Note:

1. Reflow soldering is recommended at the temperatures and times shown, no more than three times.
2. Avoid direct contact between the epoxy body and any tools or surfaces exceeding its maximum storage temperature.
3. Application of pressure on the epoxy body is prohibited at elevated temperatures. In specific scenarios, any applied force must not exceed 2.5N.
4. Ensure the component has cooled to ambient temperature before proceeding with any subsequent manufacturing steps.
5. The component has a shelf life of one year when stored under standard conditions.
6. Recommend storage Temp.: 0~40°C;  
Recommend storage humidity: <60%;  
MSL level: MSL 1

Information furnished in this document is believed to be accurate and reliable. However, Jiangsu JieJie Microelectronics Co., Ltd. assumes no responsibility for the consequences of use without consideration for such information nor use beyond it. Information mentioned in this document is subject to change without notice, apart from that when an agreement is signed, Jiangsu JieJie complies with the agreement.

Products and information provided in this document have no infringement of patents. Jiangsu JieJie assumes no responsibility for any infringement of other rights of third parties which may result from the use of such products and information. This document supersedes and replaces all information previously supplied.

 is a registered trademark of Jiangsu JieJie Microelectronics Co., Ltd.

Copyright © 2026 Jiangsu JieJie Microelectronics Co., Ltd. All rights reserved.