

### DESCRIPTION:

The products are Darlington transistor opto-couplers in a plastic SOP4 package. The device combines an AlGaAs infrared emitting diodes the emitter which is optically coupled to a silicon planar phototransistor detector. With the robust coplanar double mold structure, the device provides the most stable isolation feature. The products are widely used in switch mode power supplies, programmable controllers, household appliances and office equipment.

### MAIN FEATURES

- High isolation 3750 VRMS
- Operating temperature range -40°C to 110°C
- RoHS & REACH Compliance
- HBM: H3A; MM: M4; CDM: C3
- CQC approved
- VDE approved
- UL approved

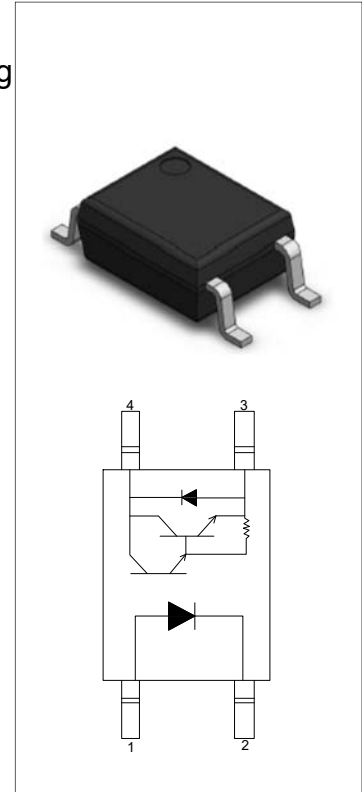

### ABSOLUTE MAXIMUM RATINGS (Temperature=25°C)

Parameter		Symbol	Value	Unit
Input	Forward Current	$I_F$	50	mA
	Peak Forward Current	$I_{FP}$	1 <sup>①</sup>	A
	Reverse Voltage	$V_R$	6	V
	Power Dissipation	$P_D$	75	mW
Output	Collector-emitter Voltage	$V_{CEO}$	300	V
	Emitter-collector Voltage	$V_{ECO}$	0.3	V
	Collector Current	$I_C$	150	mA
	Power Dissipation	$P_C$	150	mW
Total Power Dissipation		$P_{tot}$	225	mW
Isolation Voltage		$V_{iso}$	3750 <sup>②</sup>	Vrms
Operating Temperature		$T_{opr}$	-40~+110	°C
Junction Temperature		$T_j$	125	°C

Storage Temperature	T <sub>stg</sub>	-55~+125	°C
Soldering Temperature	T <sub>sol</sub>	260	°C

**NOTE1**: 100μs pulse, 100Hz frequency

**NOTE2**: AC for 1minute, R.H.=40~60%

### ELECTRICAL CHARACTERISTICS (Temperature=25°C)

Parameter		Symbol	Condition	Min.	Typ.	Max.	Unit
Input	Forward Voltage	V <sub>F</sub>	I <sub>F</sub> =10mA	-	1.2	1.5	V
	Reverse Current	I <sub>R</sub>	V <sub>R</sub> =6V	-	-	1	μA
	Terminal Capacitance	C <sub>t</sub>	V=0, f=1MHz	-	10	-	pF
Output	Collector-Emitter dark current	I <sub>CEO</sub>	V <sub>CE</sub> =200V, I <sub>F</sub> =0	-	-	200	nA
	Collector-Emitter breakdown voltage	BV <sub>CEO</sub>	I <sub>C</sub> =0.1mA I <sub>F</sub> =0	300	-	-	V
	Emitter-Collector breakdown voltage	BV <sub>ECO</sub>	I <sub>E</sub> =0.1mA I <sub>F</sub> =0	0.3	-	-	V
Transfer Characteristics	Current transfer ratio	CTR <sup>①</sup>	I <sub>F</sub> =1mA V <sub>CE</sub> =2V	1000	-	7500	%
	Collector-Emitter Saturation Voltage	V <sub>CE(sat)</sub>	I <sub>F</sub> =1mA I <sub>C</sub> =10mA	-	-	1	V
	Isolation resistance	R <sub>io</sub>	DC500V 40~60%R.H.	10 <sup>12</sup>	-	-	Ω
	Floating Capacitance	C <sub>io</sub>	V=0, f=1MHz	-	0.8	-	pF
	Rise Time	t <sub>r</sub>	V <sub>CE</sub> =10V, I <sub>C</sub> =10mA R <sub>L</sub> =100Ω	-	40	-	μs
	Fall Time	t <sub>f</sub>		-	15	-	μs
	Response Time	t <sub>on</sub>		-	50	-	μs
t <sub>off</sub>		-		15	-	μs	

**NOTE1**: Rank Table of Current Transfer Ratio (Temperature=25°C)

Grade Sign	Test Condition	Min. (%)	Max. (%)
J	I <sub>F</sub> =140μA, V <sub>CE</sub> =2V	-	40
	I <sub>F</sub> =300μA, V <sub>CE</sub> =2V	500	-
K	I <sub>F</sub> =1mA, V <sub>CE</sub> =2V	1000	7500
L	I <sub>F</sub> =1mA, V <sub>CE</sub> =1V	2000	7500

**ORDERING INFORMATION**

<p><b>J</b></p> <p>JieJie Microelectronics Co., Ltd.</p>	<p><b>OC</b></p> <p>Opto Coupler</p> <p>Darlington Transistor</p>	<p><b>T</b></p>	<p><b>352</b></p> <p>Marketization Model</p>	<p><b>J</b></p> <p>CTR Rank:J/K/L</p>	<p><b>-M4</b></p> <p>SOP4</p>	<p><b>/</b></p> <p>None:T1 R:T2</p>
--	---	-----------------	--	---------------------------------------	-------------------------------	---

Packing Quantity	
Option	Quantity
None/R	3000 Units/Reel

**MARKING**

	<p><u>YWWZZX</u></p> <p>LOT NO.</p>
---	-------------------------------------

Characteristics Curves

FIG.1: Max. Allowable LED Forward Current vs. Ambient Temperature

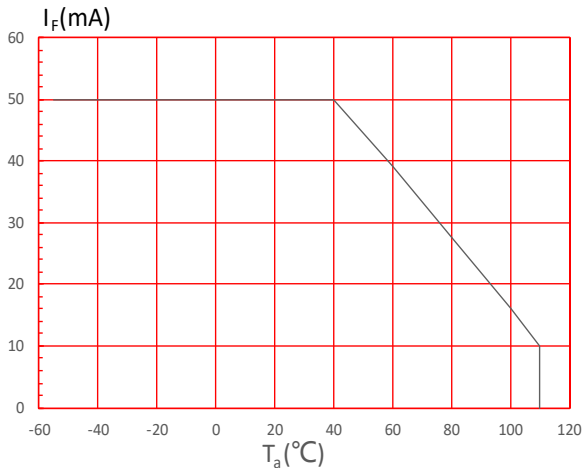

FIG.2: Collector Power Dissipation vs. Ambient Temperature

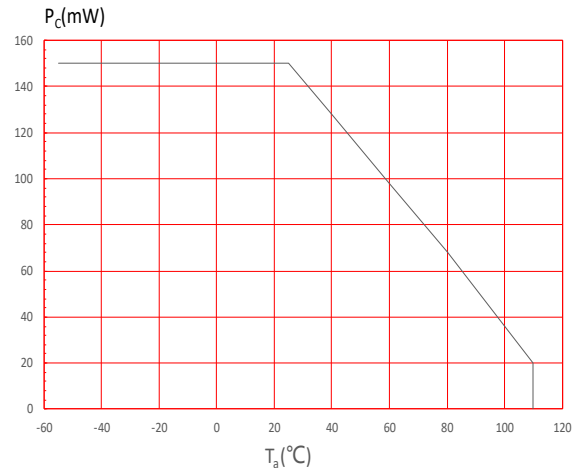

FIG.3: Forward Current vs. Forward Voltage

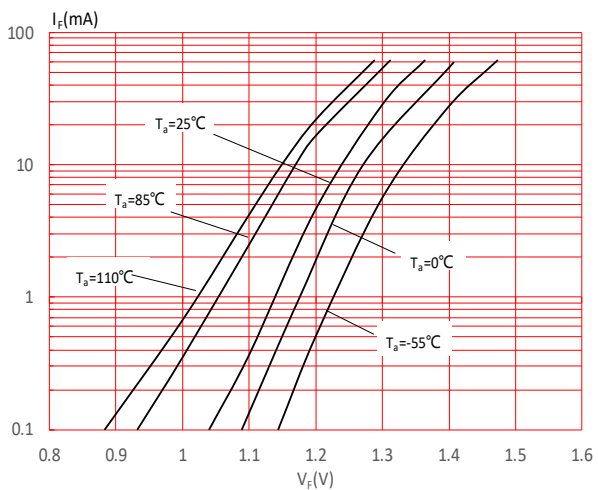
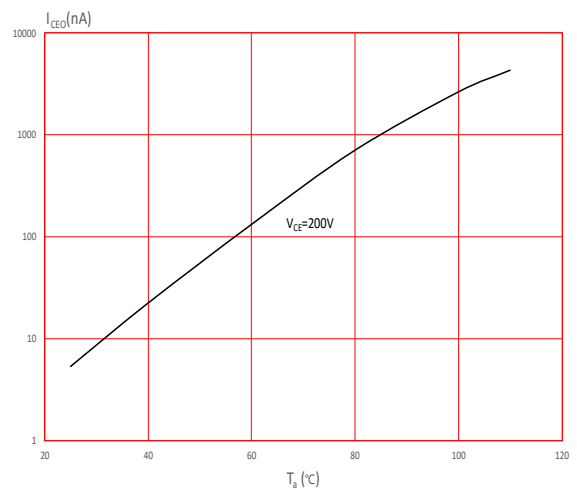

FIG.4: Collector Dark Current vs. Ambient Temperature



Test Circuits

FIG.5: Test Circuits of Propagation Delay Time

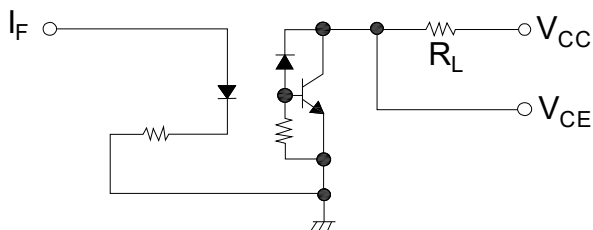
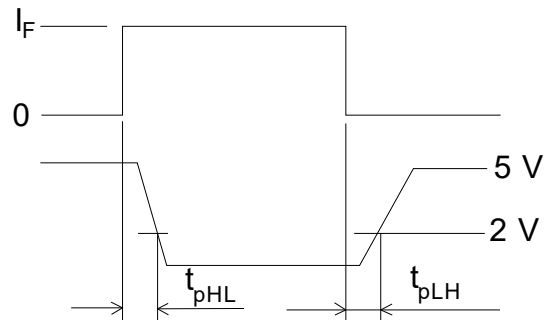
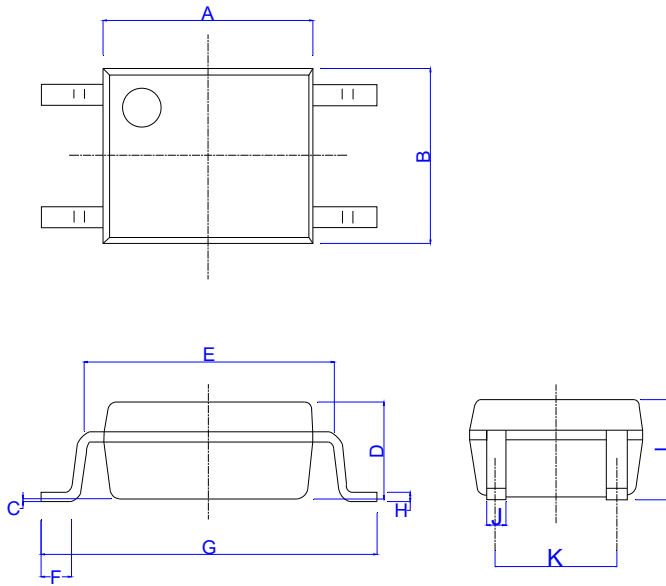

FIG.6: Curves of Propagation Delay Time



Package Dimension (Unit: mm)



Ref.	Dimensions					
	Millimeters			Inches		
	Min.	Typ.	Max.	Min.	Typ.	Max.
A	4.40		4.80	0.173		0.189
B	3.60		4.20	0.142		0.165
C	0.00		0.20	0.000		0.008
D	1.90		2.30	0.075		0.091
E	5.00		5.60	0.197		0.220
F	0.34		0.94	0.013		0.037
G	6.70		7.30	0.264		0.287
H	0.10		0.30	0.004		0.012
I	2.00		2.40	0.079		0.094
J	0.25		0.55	0.010		0.022
K	2.29		2.79	0.090		0.110

RECOMMENDED SOLDER MASK (Dimensions in mm unless otherwise stated)

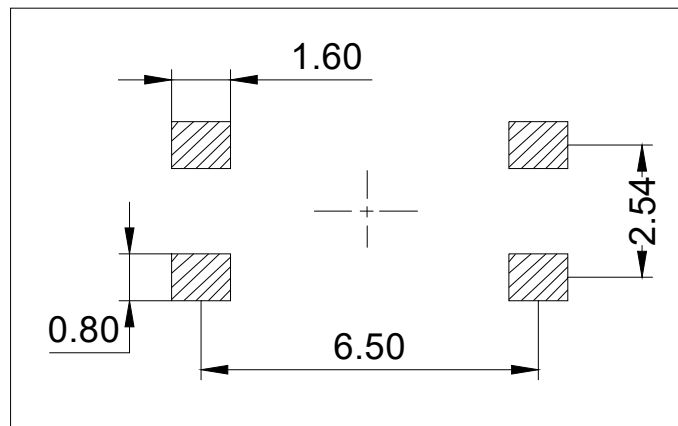

**CARRIER TAPE SPECIFICATIONS (Dimensions in mm unless otherwise stated)**

**Option None**

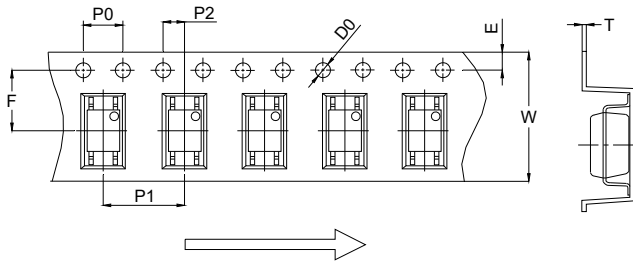

Ref.	Dimensions					
	Millimeters			Inches		
	Min.	Typ.	Max.	Min.	Typ.	Max.
D0		1.50	1.60		0.059	0.063
P0	3.90	4.00	4.10	0.154	0.157	0.161
P1	7.90	8.00	8.10	0.311	0.315	0.319
P2	1.90	2.00	2.10	0.075	0.079	0.083
E	1.65	1.75	1.85	0.065	0.069	0.073
F	4.40	4.50	4.60	0.173	0.177	0.181
T	0.25	0.30	0.35	0.010	0.012	0.014
W	11.90	12.00	12.30	0.469	0.472	0.484

**Option R**

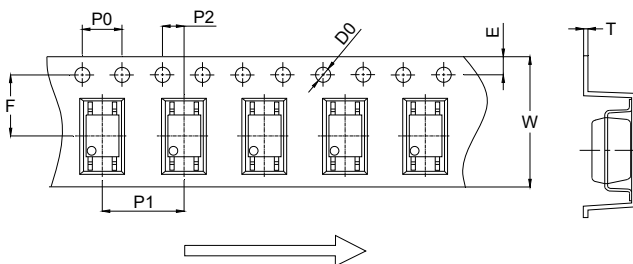

Ref.	Dimensions					
	Millimeters			Inches		
	Min.	Typ.	Max.	Min.	Typ.	Max.
D0		1.50	1.60		0.059	0.063
P0	3.90	4.00	4.10	0.154	0.157	0.161
P1	7.90	8.00	8.10	0.311	0.315	0.319
P2	1.90	2.00	2.10	0.075	0.079	0.083
E	1.65	1.75	1.85	0.065	0.069	0.073
F	4.40	4.50	4.60	0.173	0.177	0.181
T	0.25	0.30	0.35	0.010	0.012	0.014
W	11.90	12.00	12.30	0.469	0.472	0.484

**REFLOW INFORMATION**

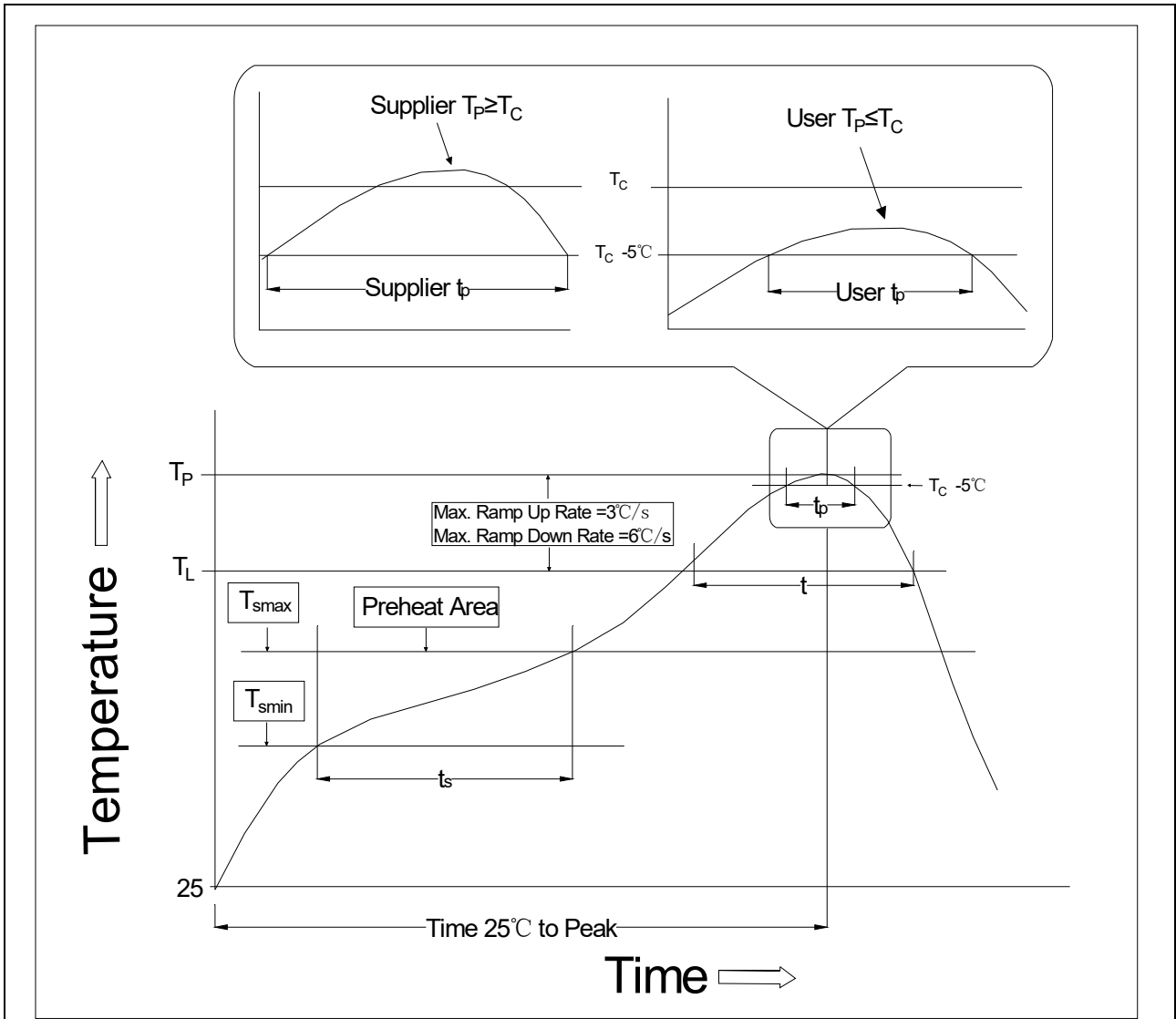

Profile Feature	Sn-Pb Assembly Profile	Pb-Free Assembly Profile
Temperature Min. (T <sub>smin</sub> )	100	150°C
Temperature Max. (T <sub>smax</sub> )	150	200°C
Time (t <sub>s</sub> ) from (T <sub>smin</sub> to T <sub>smax</sub> )	60-120 seconds	60-120 seconds
Ramp-up Rate (t <sub>L</sub> to t <sub>P</sub> )	3°C/second max.	3°C/second max.
Liquidus Temperature (T <sub>L</sub> )	183°C	217°C
Time (t <sub>L</sub> ) Maintained Above (T <sub>L</sub> )	60-150 seconds	60-150 seconds
Peak Body Package Temperature	235°C+0°C/-5°C	260°C+0°C/-5°C
Time (t <sub>P</sub> ) within 5°C of 260°C	20 seconds	30 seconds
Ramp-down Rate (T <sub>P</sub> to T <sub>L</sub> )	6°C/second max.	6°C/second max.
Time 25°C to Peak Temperature	6 minutes max.	8 minutes max.

Note:

1. Reflow soldering is recommended at the temperatures and times shown, no more than three times.
2. Avoid direct contact between the epoxy body and any tools or surfaces exceeding its maximum storage temperature.
3. Application of pressure on the epoxy body is prohibited at elevated temperatures. In specific scenarios, any applied force must not exceed 2.5N.
4. Ensure the component has cooled to ambient temperature before proceeding with any subsequent manufacturing steps.
5. The component has a shelf life of one year when stored under standard conditions.
6. Recommend storage Temp.: 0~40°C;  
Recommend storage humidity: <60%;  
MSL level: MSL 1

Information furnished in this document is believed to be accurate and reliable. However, Jiangsu JieJie Microelectronics Co., Ltd. assumes no responsibility for the consequences of use without consideration for such information nor use beyond it. Information mentioned in this document is subject to change without notice, apart from that when an agreement is signed, Jiangsu JieJie complies with the agreement.

Products and information provided in this document have no infringement of patents. Jiangsu JieJie assumes no responsibility for any infringement of other rights of third parties which may result from the use of such products and information. This document supersedes and replaces all information previously supplied.

 is a registered trademark of Jiangsu JieJie Microelectronics Co., Ltd.

Copyright © 2026 Jiangsu JieJie Microelectronics Co., Ltd. All rights reserved.