

DESCRIPTION:

The products are voltage opto-couplers in a VSON4 package. The device consists of a high-voltage output detector circuit. It is capable of directly driving gates of power MOSFETs or IGBTs. The products are widely used in supply for electronic circuit and drive solid state relay.

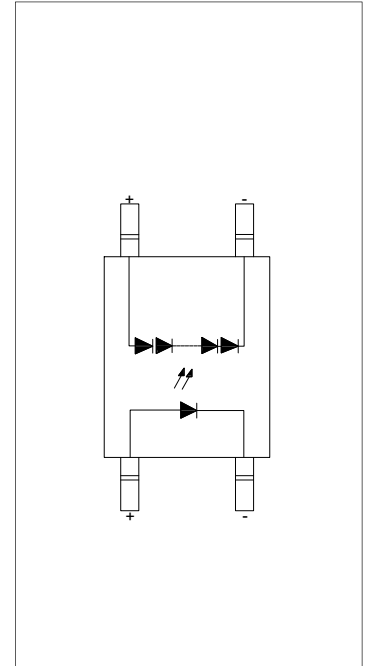

MAIN FEATURES

- High isolation 500 VRMS
- Operating temperature range -40°C to 110°C
- RoHS & REACH Compliance
- HBM: H3A; MM: M4; CDM: C3
- CQC approved
- VDE approved
- UL approved

ABSOLUTE MAXIMUM RATINGS (Temperature=25°C)

Parameter		Symbol	Value	Unit
Input	Forward Current	I_F	50	mA
	Peak Forward Current	I_{FP}	1 ^①	A
	Reverse Voltage	V_R	6	V
	Power Dissipation	P_D	75	mW
Isolation Voltage		V_{iso}	500 ^②	Vrms
Operating Temperature		T_{opr}	-40~+110	°C
Junction Temperature		T_j	125	°C
Storage Temperature		T_{stg}	-55~+125	°C
Soldering Temperature		T_{sol}	260	°C

NOTE1: 100μs pulse, 100Hz frequency

NOTE2: AC for 1minute, R.H.=40~60%

ELECTRICAL CHARACTERISTICS (Temperature=25°C)

Parameter		Symbol	Condition	Min.	Typ.	Max.	Unit
Input	Forward Voltage	V_F	$I_F=10\text{mA}$	-	1.8	2.5	V
	Reverse Current	I_R	$V_R=6\text{V}$	-	-	1	μA
Output	Open Circuit Voltage	V_{OC}	$I_F=10\text{mA}$ $I_O=0\text{mA}$	7	-	-	V
	Short Circuit Current	I_{SC}	$I_F=10\text{mA}$ $V_O=0\text{V}$	20	-	-	μA
Transfer Characteristics	Isolation resistance	R_{IO}	DC500V 40~60%R.H.	10^{12}	-	-	Ω
	Response Time	t_{on}	$I_F=10\text{mA}$	-	40	-	μs
		t_{off}		-	50	-	μs

ORDERING INFORMATION

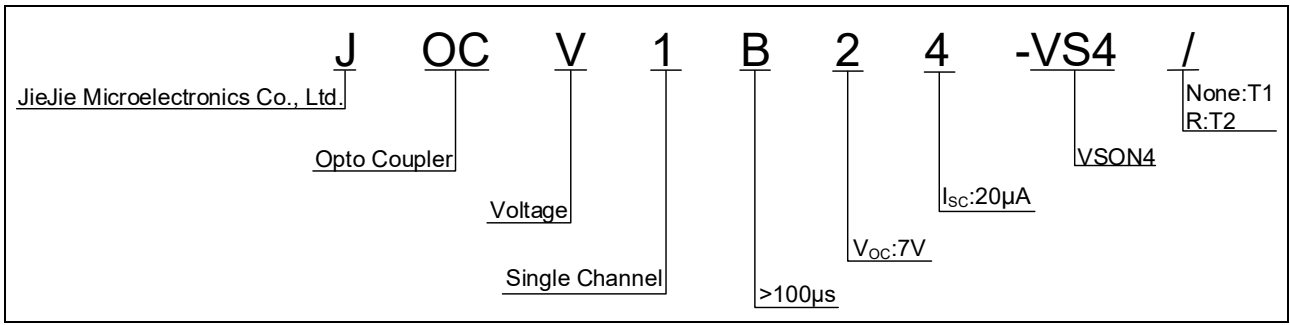

Packing Quantity	
Option	Quantity
VSON4	3000 Units/Reel

MARKING

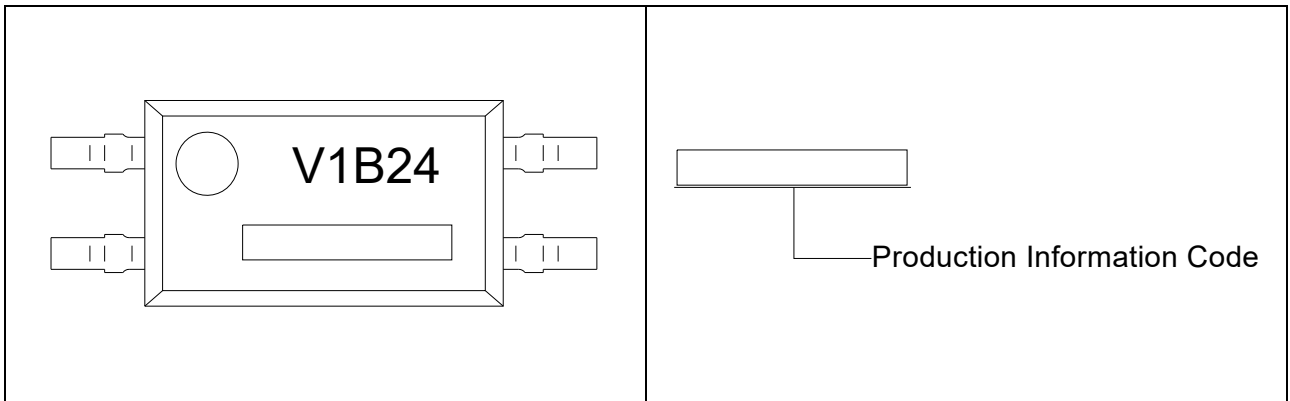

Characteristics Curves

FIG.1: Max. Allowable LED Forward Current vs. Ambient Temperature

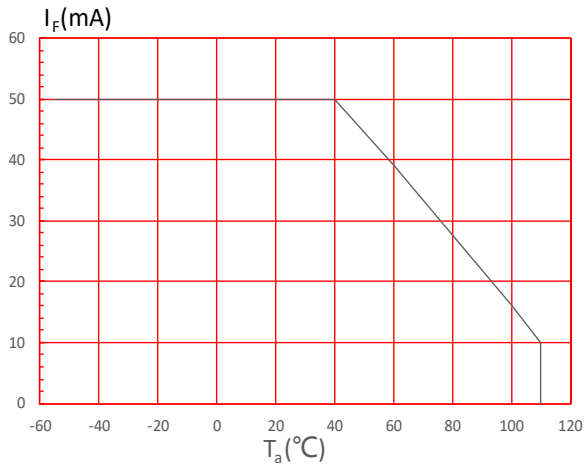

FIG.2: Forward Current vs. Forward Voltage

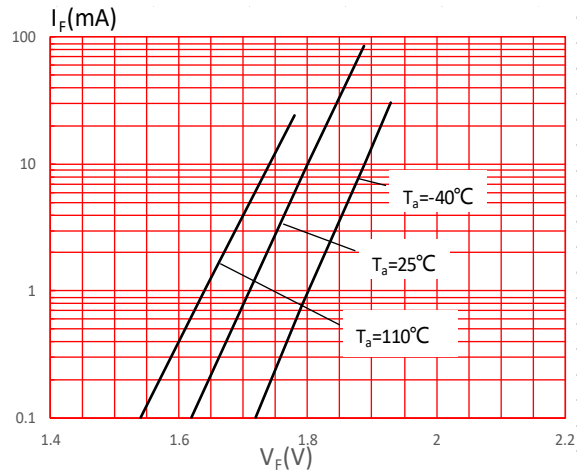

FIG.3: Open Circuit Voltage vs. Forward Current

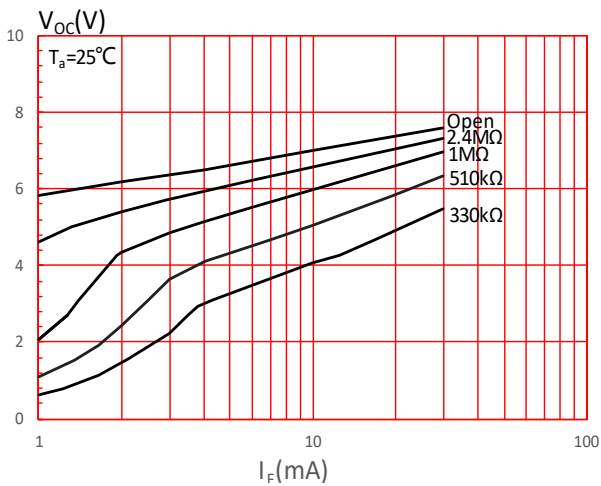

FIG.4: Short Circuit Current vs. Forward Current

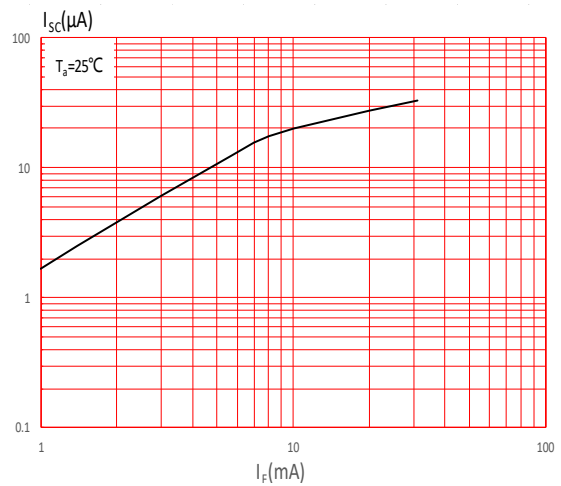

FIG.5: Open Circuit Voltage vs. Ambient Temperature

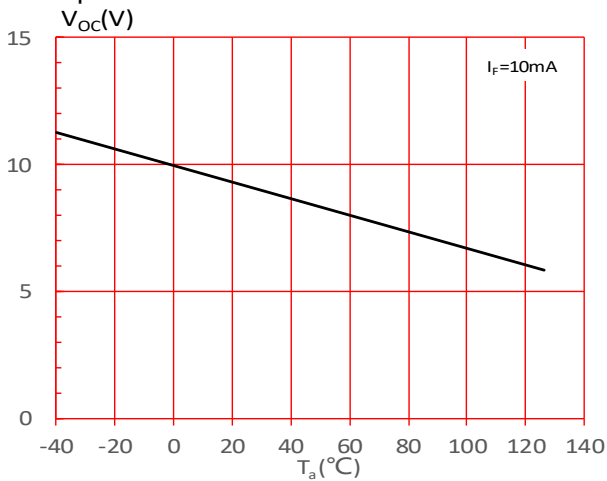
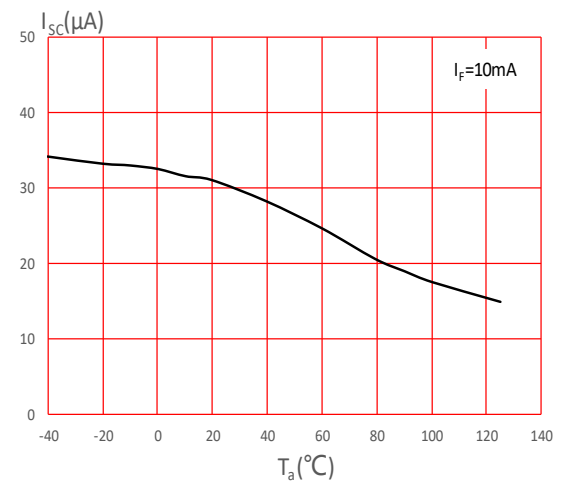
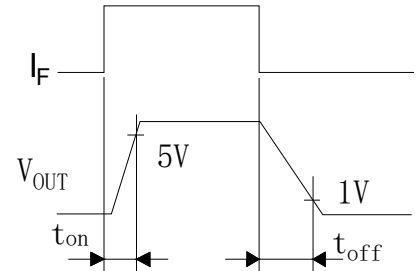
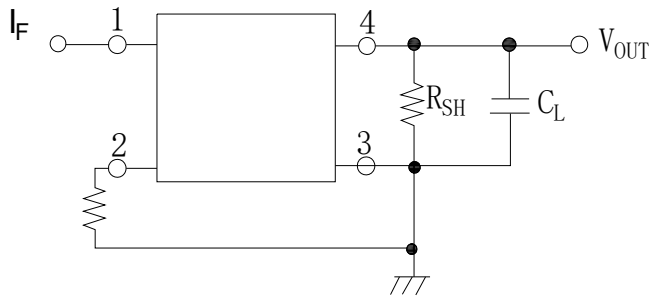

FIG.6: Short Circuit Current vs. Ambient Temperature



Test Circuits

FIG.7: Response Time Test Circuit, Waveform



Package Dimension (Unit: mm)

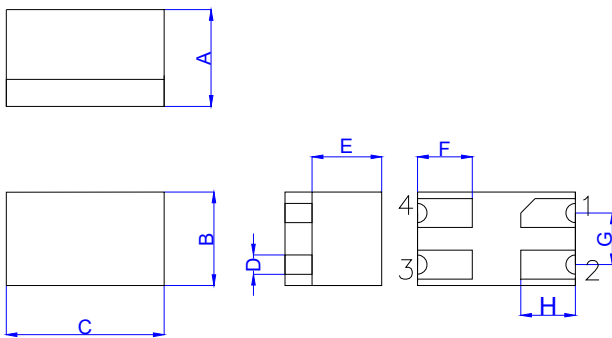

Ref.	Dimensions					
	Millimeters			Inches		
	Min.	Typ.	Max.	Min.	Typ.	Max.
A	1.30		1.70	0.051		0.067
B	1.25		1.65	0.049		0.065
C	2.25		2.65	0.089		0.104
D	0.10		0.50	0.004		0.020
E	0.88		1.28	0.035		0.050
F	0.65		1.05	0.026		0.041
G	0.60		1.00	0.024		0.039
H	0.65		1.05	0.026		0.041

RECOMMENDED SOLDER MASK (Dimensions in mm unless otherwise stated)

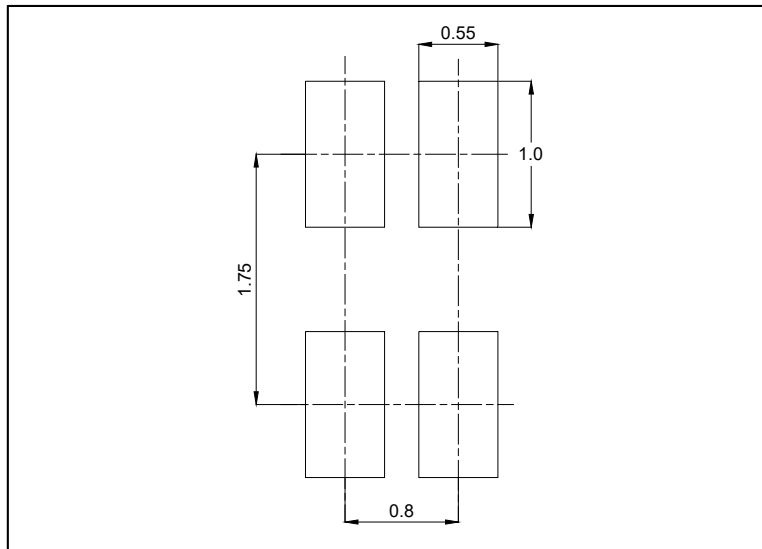

CARRIER TAPE SPECIFICATIONS (Dimensions in mm unless otherwise stated)

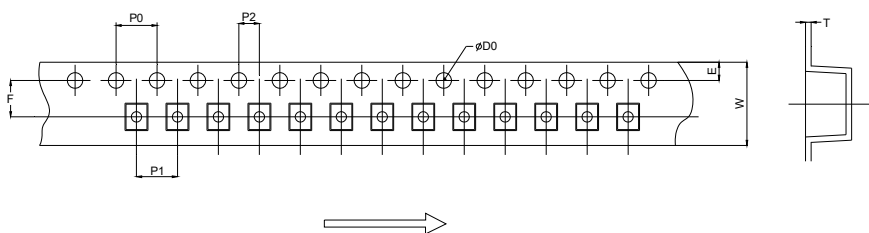

Ref.	Dimensions					
	Millimeters			Inches		
	Min.	Typ.	Max.	Min.	Typ.	Max.
D0		1.50	1.60		0.059	0.063
P0	3.90	4.00	4.10	0.154	0.157	0.161
P1	3.90	4.00	4.10	0.154	0.157	0.161
P2	1.90	2.00	2.10	0.075	0.079	0.083
E	1.65	1.75	1.85	0.065	0.069	0.073
F	3.40	3.50	3.60	0.134	0.138	0.142
T	0.20	0.25	0.30	0.008	0.010	0.012
W	7.70	8.00	8.30	0.303	0.315	0.327

REFLOW INFORMATION

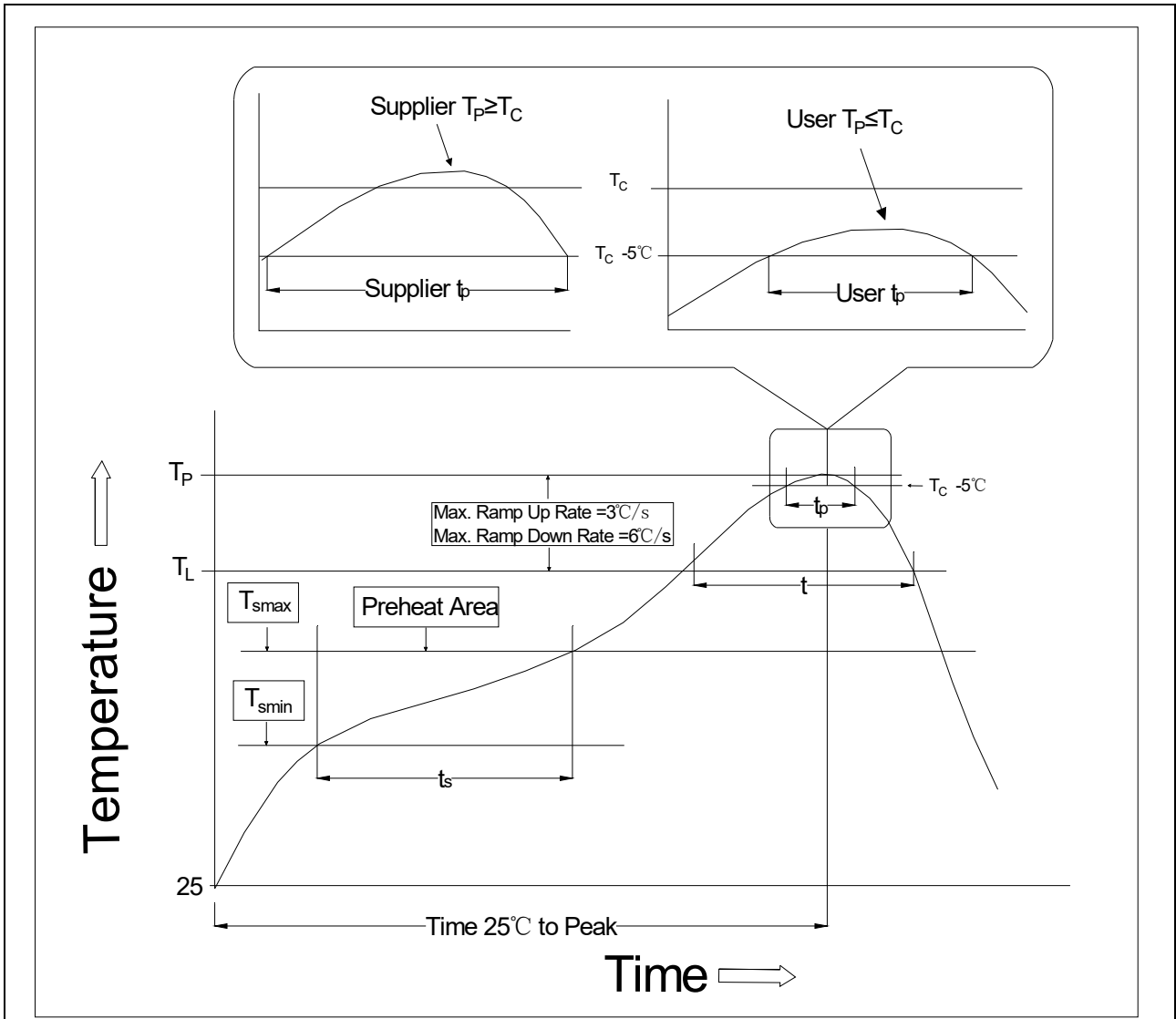

Profile Feature	Sn-Pb Assembly Profile	Pb-Free Assembly Profile
Temperature Min. (T _{smin})	100°C	150°C
Temperature Max. (T _{smax})	150°C	200°C
Time (t _s) from (T _{smin} to T _{smax})	60-120 seconds	60-120 seconds
Ramp-up Rate (t _L to t _P)	3°C/second max.	3°C/second max.
Liquidus Temperature (T _L)	183°C	217°C
Time (t _L) Maintained Above (T _L)	60-150 seconds	60-150 seconds
Peak Body Package Temperature	235°C+0°C/-5°C	260°C+0°C/-5°C
Time (t _P) within 5°C of 260°C	10 seconds	10 seconds
Ramp-down Rate (T _P to T _L)	3-6°C/second	3-6°C/second
Time 25°C to Peak Temperature	6 minutes max.	8 minutes max.

Note:

1. Reflow soldering is recommended at the temperatures and times shown, no more than three times.
2. Avoid direct contact between the epoxy body and any tools or surfaces exceeding its maximum storage temperature.
3. Application of pressure on the epoxy body is prohibited at elevated temperatures. In specific scenarios, any applied force must not exceed 2.5N.
4. Ensure the component has cooled to ambient temperature before proceeding with any subsequent manufacturing steps.
5. The component has a shelf life of one year when stored under standard conditions.
6. Recommend storage Temp.: 0~40°C;
Recommend storage humidity: <60%;
MSL level: MSL 1

Information furnished in this document is believed to be accurate and reliable. However, Jiangsu JieJie Microelectronics Co., Ltd. assumes no responsibility for the consequences of use without consideration for such information nor use beyond it. Information mentioned in this document is subject to change without notice, apart from that when an agreement is signed, Jiangsu JieJie complies with the agreement.

Products and information provided in this document have no infringement of patents. Jiangsu JieJie assumes no responsibility for any infringement of other rights of third parties which may result from the use of such products and information. This document supersedes and replaces all information previously supplied.

 is a registered trademark of Jiangsu JieJie Microelectronics Co., Ltd.

Copyright © 2026 Jiangsu JieJie Microelectronics Co., Ltd. All rights reserved.