

**Key performance:**

- $V_{CE}=650V$
- $I_C=10A@T_C=100^{\circ}C$
- $V_{CE(sat)}=1.8 V$

TO-263

**Features:**

- High ruggedness performance
- 10 $\mu$ s short circuit capability
- Positive  $V_{CE(sat)}$  temperature coefficient
- High efficiency for motor control
- Excellent current sharing in parallel operation
- RoHS compliant

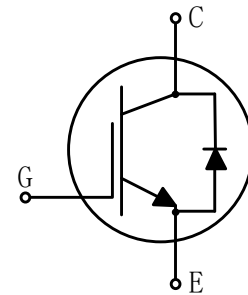
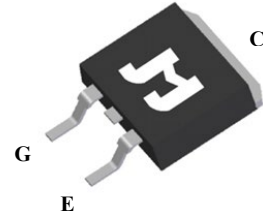
**Applications:**

- Home appliances
- Motor drives

**Package parameters**

Type	Marking	Package	Packaging method
JJT10N65SC	T1065SC	TO-263	Tape and reel

## Maximum ratings

Symbol	Parameter	Values	Unit
$V_{CES}$	Collector-emitter voltage	650	V
$V_{GES}$	Gate-emitter voltage	±20	V
$I_C$	Continuous collector current ( $T_C=25^\circ\text{C}$ )	20	A
	Continuous collector current ( $T_C=100^\circ\text{C}$ )	10	A
$I_{CM}$	Pulsed collector current, $t_p$ limited by $T_{vjmax}$	40	A
$I_F$	Diode continuous forward current ( $T_C=100^\circ\text{C}$ )	10	A
$I_{FM}$	Diode maximum current, $t_p$ limited by $T_{vjmax}$	40	A
$t_{sc}$	Short circuit withstand time	10	µs
$P_{tot}$	Power dissipation ( $T_C=25^\circ\text{C}$ )	100	W
	Power dissipation ( $T_C=100^\circ\text{C}$ )	50	W
$T_{vj}$	Operating junction temperature range	-40 to +175	°C
$T_{stg}$	Storage temperature range	-55 to +150	°C

## Thermal characteristics

Symbol	Parameter	Values		Unit
		Typ.	Max.	
$R_{th(j-c)}$	Thermal resistance, junction to case for IGBT	-	1.5	K/ W
$R_{th(j-c)}$	Thermal resistance, junction to case for Diode	-	1.8	K/ W
$R_{th(j-a)}$	Thermal resistance, junction to ambient	-	50	K/ W

**Electrical characteristics of IGBT** ( $T_{vj}=25^{\circ}\text{C}$  unless otherwise specified)

**Static characteristics**

Symbol	Parameter	Test condition	Values			Unit
			Min.	Typ.	Max.	
$BV_{CES}$	Collector-emitter breakdown voltage	$V_{GE}=0\text{V}, I_C=250\mu\text{A}$	650	-	-	V
$I_{CES}$	Collector-emitter leakage current	$V_{CE}=650\text{V}, V_{GE}=0\text{V}$	-	-	50	$\mu\text{A}$
$I_{GES}$	Gate leakage current, forward	$V_{GE}=20\text{V}, V_{CE}=0\text{V}$	-	-	100	nA
	Gate leakage current, reverse	$V_{GE}=-20\text{V}, V_{CE}=0\text{V}$	-	-	-100	nA
$V_{GE(th)}$	Gate-emitter threshold voltage	$V_{GE}=V_{CE}, I_C=250\mu\text{A}$	5.5	5.7	6.0	V
$V_{CE(sat)}$	Collector-emitter saturation voltage	$V_{GE}=15\text{V}, I_C=10\text{A}$	-	1.8	-	V
		$V_{GE}=15\text{V}, I_C=10\text{A}, T_{vj}=150^{\circ}\text{C}$	-	2.1	-	V

**Dynamic characteristics**

Symbol	Parameter	Test condition	Values			Unit
			Min.	Typ.	Max.	
$C_{ies}$	Input capacitance	$V_{CE}=30\text{V}$ $V_{GE}=0\text{V}$ $f=1\text{MHz}$	-	670	-	pF
$C_{oes}$	Output capacitance		-	37	-	pF
$C_{res}$	Reverse transfer capacitance		-	10	-	pF
$Q_g$	Total gate charge	$V_{CC}=520\text{V}$ $V_{GE}=15\text{V}$ $I_C=10\text{A}$	-	28	-	nC

## Switching characteristics

Symbol	Parameter	Test condition	Values			Unit
			Min.	Typ.	Max.	
$t_{d(on)}$	Turn-on delay time	$V_{CC}=400V$ $V_{GE}=0/15V$ $I_C=10A$ $R_G=10\Omega$ Inductive load	-	12	-	ns
$t_r$	Rise time		-	11	-	ns
$t_{d(off)}$	Turn-off delay time		-	71	-	ns
$t_f$	Fall time		-	74	-	ns
$E_{on}$	Turn-on energy		-	0.18	-	mJ
$E_{off}$	Turn-off energy		-	0.17	-	mJ
$E_{ts}$	Total switching energy		-	0.35	-	mJ
$t_{d(on)}$	Turn-on delay time	$V_{CC}=400V$ $V_{GE}=0/15V$ $I_C=10A$ $R_G=10\Omega$ Inductive load $T_{vj}=150^\circ C$	-	10	-	ns
$t_r$	Rise time		-	12	-	ns
$t_{d(off)}$	Turn-off delay time		-	86	-	ns
$t_f$	Fall time		-	112	-	ns
$E_{on}$	Turn-on energy		-	0.21	-	mJ
$E_{off}$	Turn-off energy		-	0.25	-	mJ
$E_{ts}$	Total switching energy		-	0.46	-	mJ

**Electrical characteristics of Diode** ( $T_{vj}=25^{\circ}\text{C}$  unless otherwise specified)

Symbol	Parameter	Test condition	Values			Unit
			Min.	Typ.	Max.	
$V_F$	Diode forward voltage	$I_F=10\text{A}$	-	1.4	-	V
		$I_F=10\text{A}, T_{vj}=150^{\circ}\text{C}$	-	1.2	-	V
$t_{rr}$	Diode reverse recovery time	$V_R=400\text{V}$ $I_F=10\text{A}$ $di_F/dt=-750\text{A}/\mu\text{s}$	-	57	-	ns
$I_{rrm}$	Diode peak reverse recovery current		-	12	-	A
$Q_{rr}$	Diode reverse recovery charge		-	411	-	nC
$t_{rr}$	Diode reverse recovery time	$V_R=400\text{V}$ $I_F=10\text{A}$ $di_F/dt=-750\text{A}/\mu\text{s}$ $T_{vj}=150^{\circ}\text{C}$	-	118	-	ns
$I_{rrm}$	Diode peak reverse recovery current		-	13	-	A
$Q_{rr}$	Diode reverse recovery charge		-	728	-	nC

## Typical performance characteristics

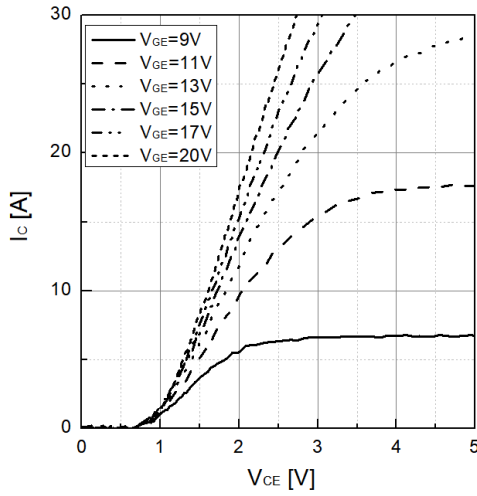

Fig 1. Typical output characteristic ( $T_{vj}=25^{\circ}\text{C}$ )

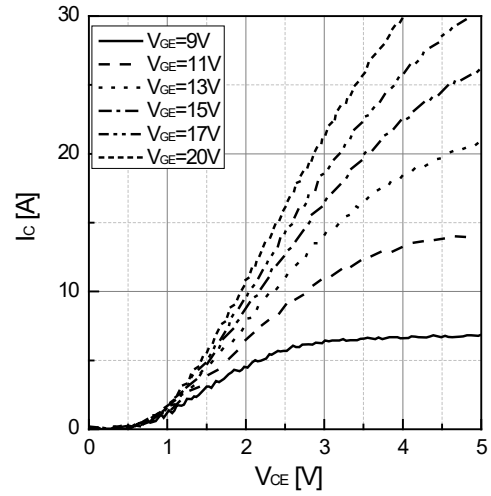

Fig 2. Typical output characteristic ( $T_{vj}=150^{\circ}\text{C}$ )

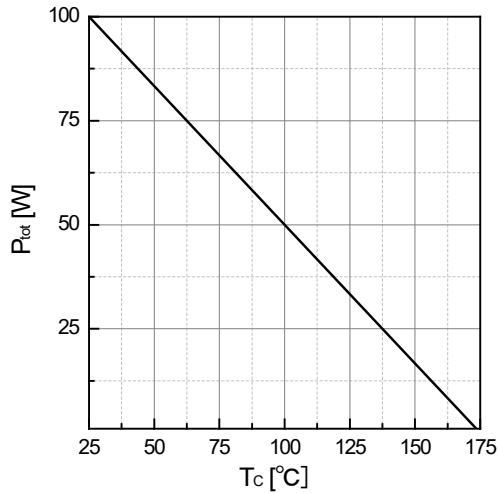

Fig 3. Power dissipation as a function of  $T_c$

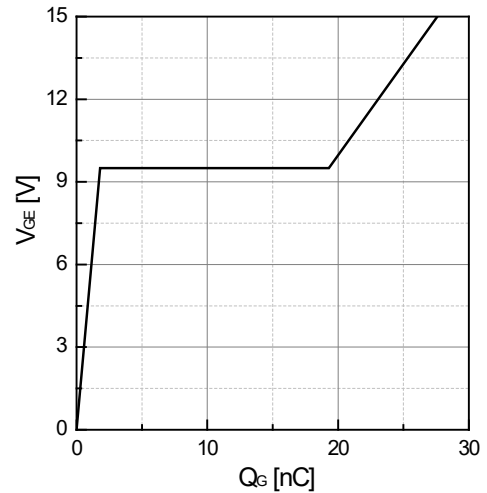

Fig 4. Typical Gate charge

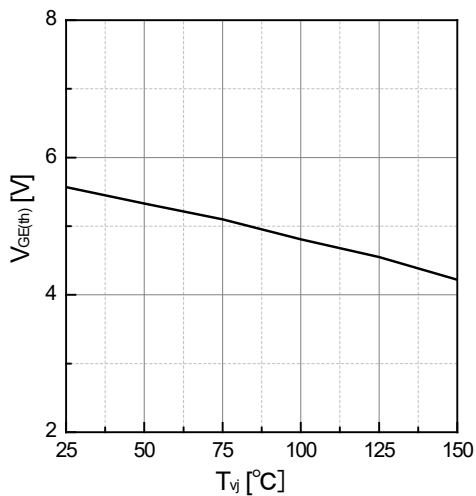

Fig 5. Typical  $V_{GE(th)}$  as a function of  $T_{vj}$   
( $I_C=1\text{mA}$ )

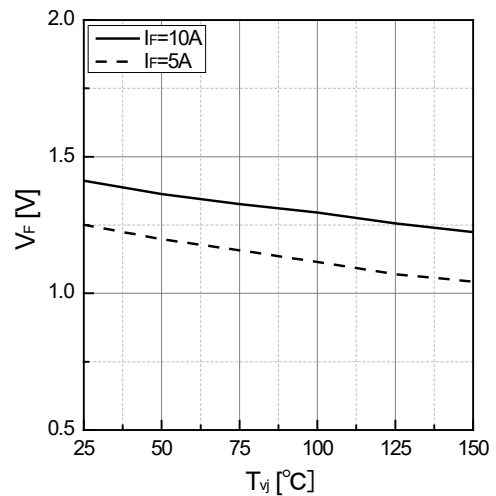

Fig 6. Typical  $V_F$  as a function of  $T_{vj}$

## Typical performance characteristics

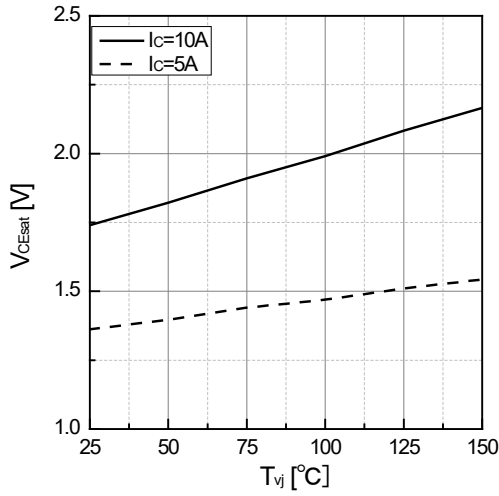

Fig 7. Typical  $V_{CEsat}$  as a function of  $T_{vj}$

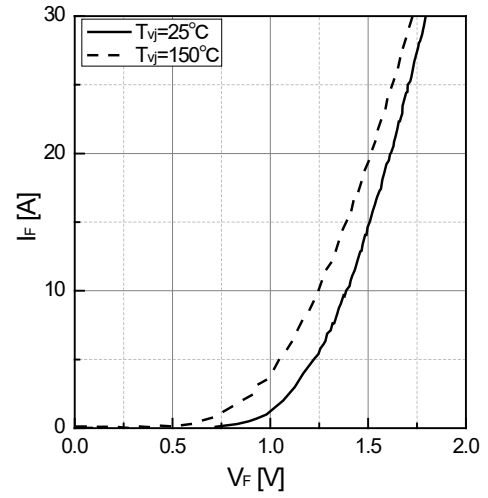

Fig 8. Typical  $I_F$  as a function of  $V_F$

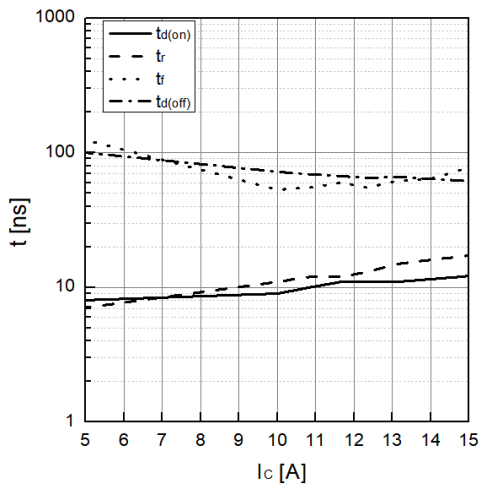

Fig 9. Typical switching time as a function of  $I_c$

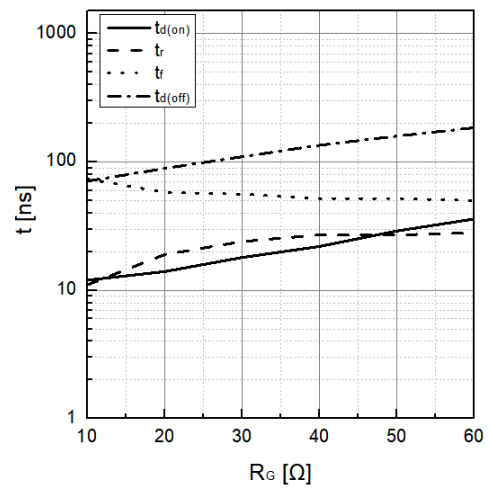

Fig 10. Typical switching times as a function of  $R_G$

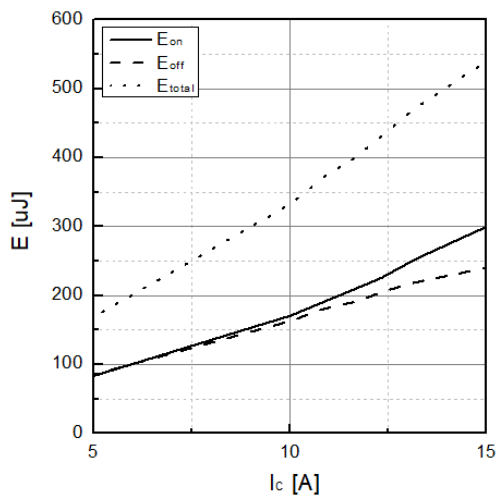

Fig 11. Typical switching energy losses as a function of  $I_c$

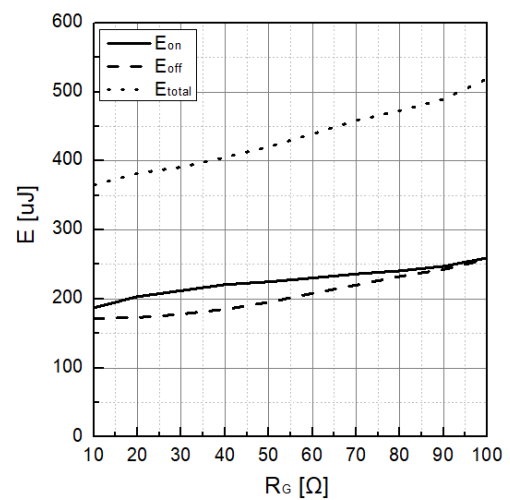

Fig 12. Typical switching energy losses as a function of  $R_G$

## Typical performance characteristics

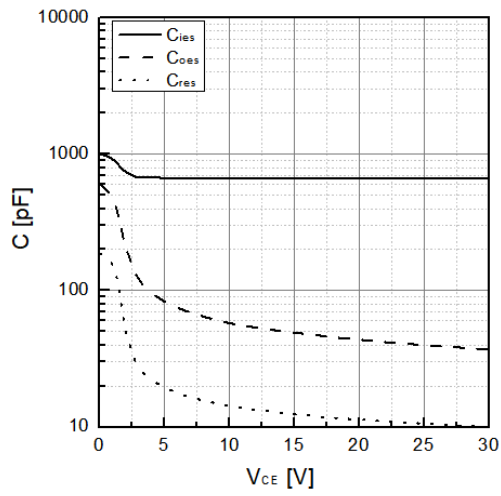
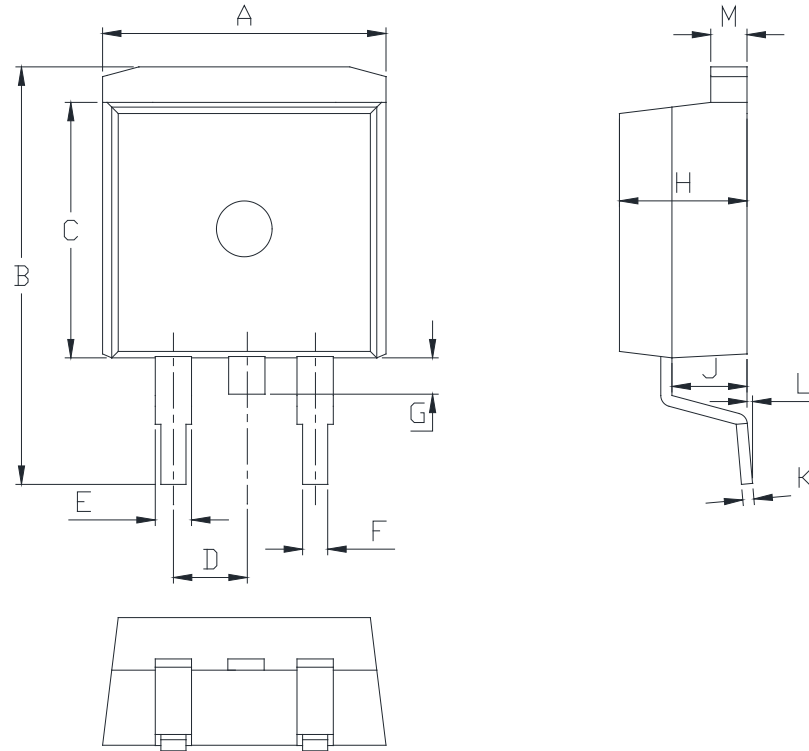

Fig 13. Typical capacitance as a function of  $V_{CE}$   
( $f=1\text{MHz}$ ,  $V_{GE}=0\text{V}$ )



**Package dimension**

TO-263



Ref.	Dimensions					
	Millimeters			Inches		
	Min.	Typ.	Max.	Min.	Typ.	Max.
A	9.90	-	10.20	0.390	-	0.402
B	14.70	-	15.80	0.579	-	0.622
C	9.4	-	9.6	0.37	-	0.378
D	-	2.54	-	-	0.100	-
E	1.20	-	1.40	0.047	-	0.055
F	0.75	-	0.85	0.029	-	0.033
G	-	-	1.75	-	-	0.069
H	4.40	-	4.70	0.173	-	0.185
J	2.30	-	2.70	0.091	-	0.106
K	0.38	-	0.55	0.015	-	0.022
L	0	0.10	0.25	0	0.004	0.010
M	1.25	-	1.35	0.049	-	0.053



## Revision history

Date	Revision	Changes
2023-12-23	Rev 1.0	Release of the datasheet

## Disclaimer

PLEASE NOTE - Jiangsu JieJie Microelectronics Co., Ltd ("JJM") reserves the right to amend, correct, modify and enhance the product and/or this document at any time without prior notice. If you intend to purchase this product, please obtain the latest information available before placing your order. The sale of JJM products is governed by JJM's prevailing terms and conditions at the time of purchase and purchasers are solely responsible for the selection and use of the products with no liability on JJM's part to supply application assistance or customization. Purchase of JJM products does not grant the purchaser license, express or implied, to JJM's intellectual property. Any warranties provided with JJM products are null and void upon resale unless accompanied by the information set forth herein in its entirety. The JJM name and logo are registered trademarks of Jiangsu JieJie Microelectronics Co., Ltd. This document supersedes all previous versions. ©2023 JJM - All rights reserved