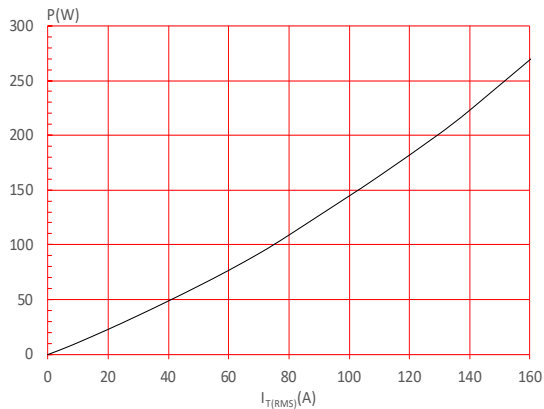



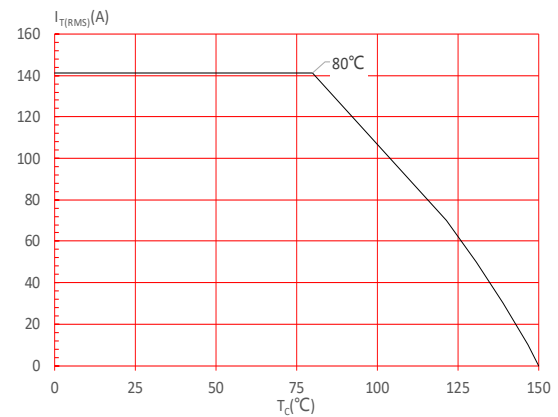



**FIG.1** Maximum power dissipation versus RMS on-state current



**FIG.2:** RMS on-state current versus case temperature



**FIG.3:** Surge peak on-state current versus number of cycles

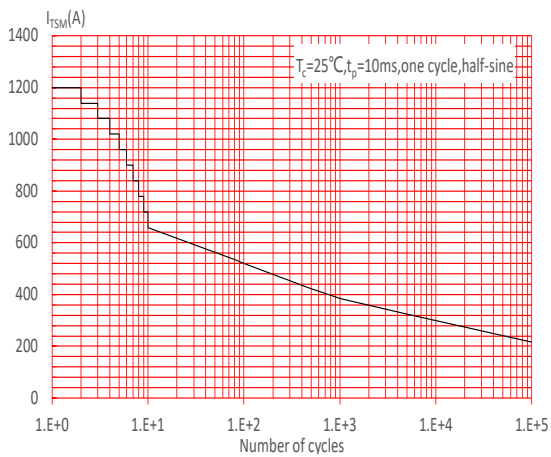

**FIG.4:** On-state characteristics

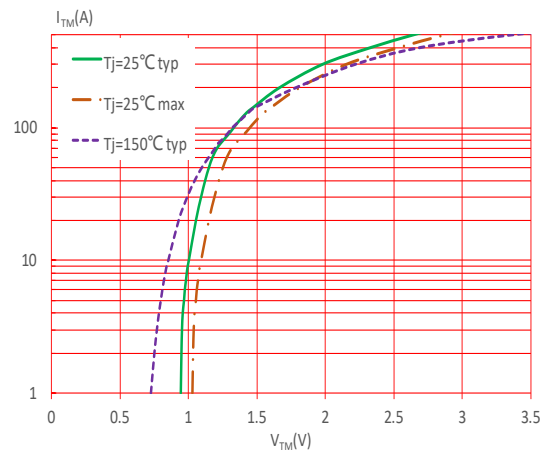

**FIG.5:** Non-repetitive surge peak on-state current for a sinusoidal pulse with width  $t_p < 10\text{ms}$ , and corresponding value of  $I^2t$  ( $di/dt < 200\text{A}/\mu\text{s}$ )

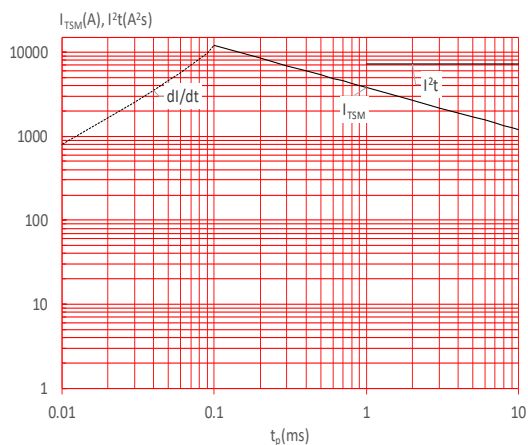

**FIG.6:** Relative variations of gate trigger current, holding current and latching current versus junction temperature

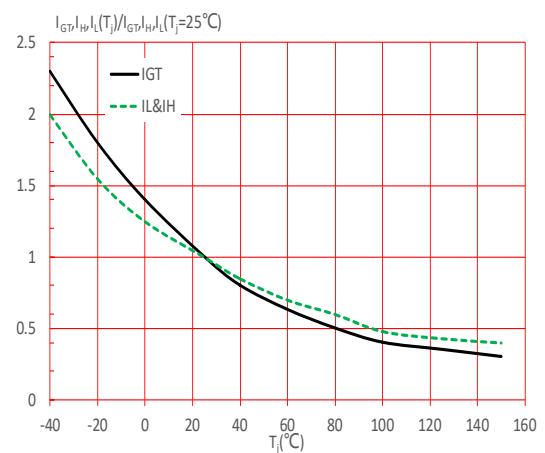
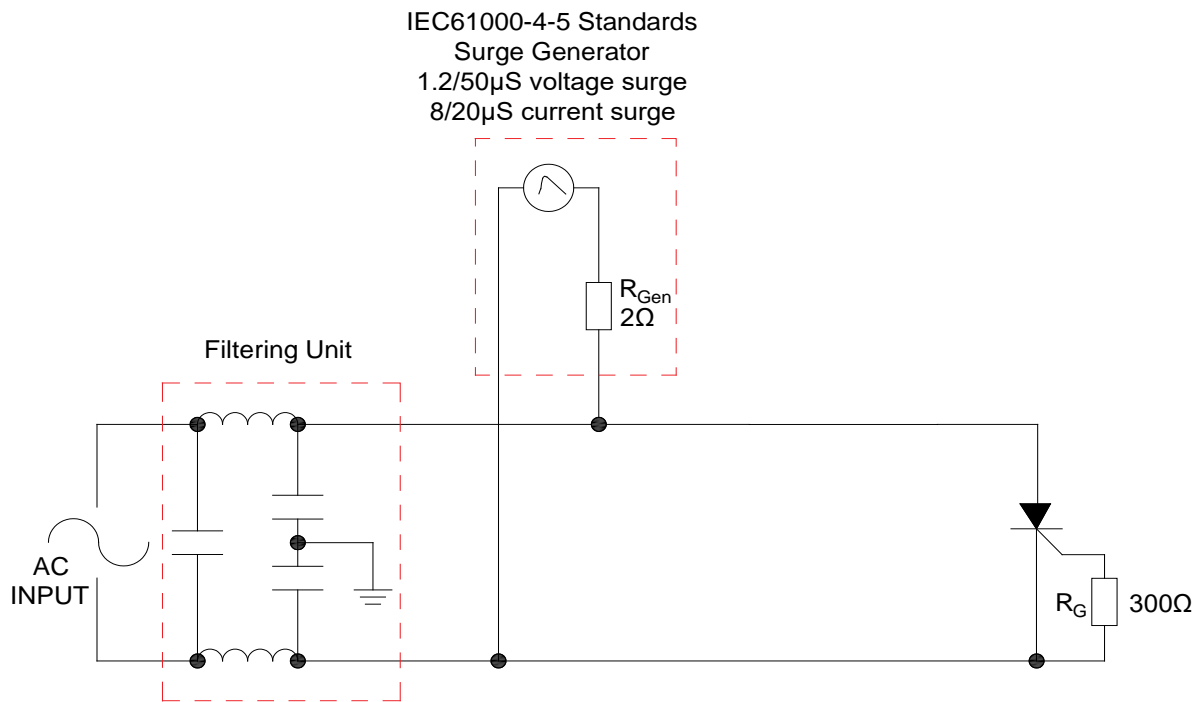

FIG.7: Test circuit for inductive and resistive loads to IEC-61000-4-5 standards.



## SHAPING AND SOLDERING PARAMETERS

Refer to 《Instructions for installation of plastic-sealed in-line power devices》 released by JieJie

**ORDERING INFORMATION**

| Order code    | Voltage<br>$V_{DRM}/V_{RRM}$ (V) | IGT(mA) | Package | Base qty.<br>(pcs) | Delivery mode |
|---------------|----------------------------------|---------|---------|--------------------|---------------|
| TYN90H-1600CS | 1600                             | 10-80   | TO-247S | 30                 | Tube          |

**Document Revision History**

| Date         | Revision | Changes     |
|--------------|----------|-------------|
| Apr.13, 2023 | A.1.0    | Last update |

**PACKAGE MECHANICAL DATA**

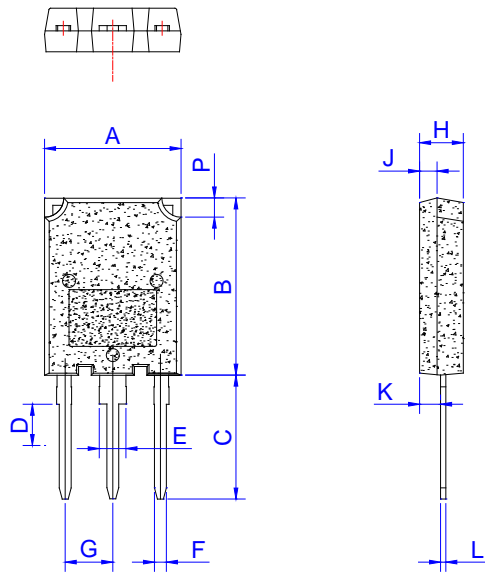

| Ref. | Dimensions  |      |      |        |      |       |
|------|-------------|------|------|--------|------|-------|
|      | Millimeters |      |      | Inches |      |       |
|      | Min.        | Typ. | Max. | Min.   | Typ. | Max.  |
| A    | 15.1        |      | 16.1 | 0.594  |      | 0.634 |
| B    | 19.8        |      | 20.8 | 0.78   |      | 0.819 |
| C    | 13.8        |      | 14.8 | 0.543  |      | 0.583 |
| D    | 3.00        |      | 4.00 | 0.118  |      | 0.157 |
| E    | 2.75        |      | 3.35 | 0.108  |      | 0.132 |
| F    | 1.30        |      | 1.50 | 0.051  |      | 0.059 |
| G    | 5.10        |      | 5.80 | 0.201  |      | 0.228 |
| H    | 4.50        |      | 5.50 | 0.177  |      | 0.217 |
| J    | 1.45        |      | 2.15 | 0.057  |      | 0.085 |
| K    | 1.90        |      | 2.80 | 0.075  |      | 0.110 |
| L    | 0.55        |      | 0.80 | 0.022  |      | 0.031 |
| P    | 2.00        |      | 2.40 | 0.079  |      | 0.094 |

**DELIVERY MODE**

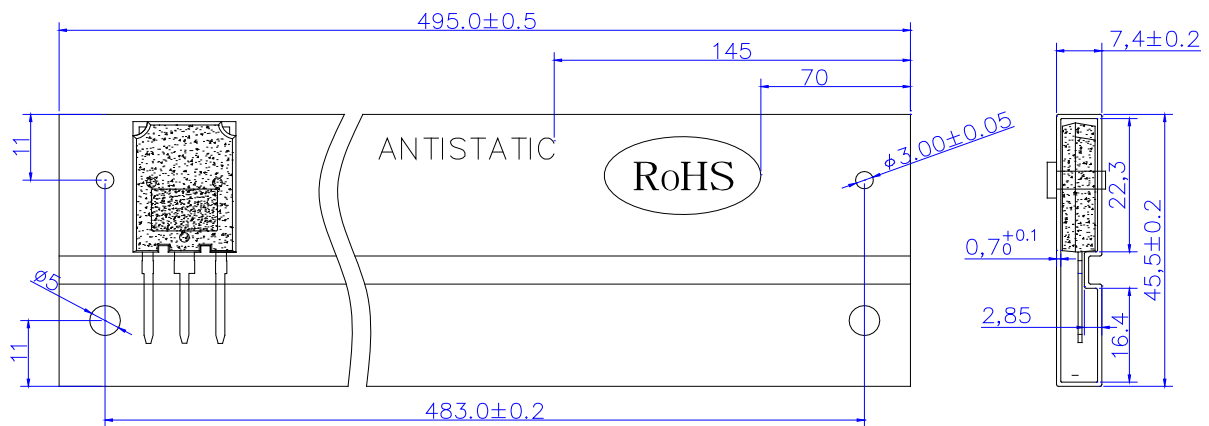

| PACKAGE | OUTLINE | TUBE (PCS) | INNER BOX (PCS) | PER CARTON |
|---------|---------|------------|-----------------|------------|
| TO-247S | TUBE    | 30         | 450             | 2,250      |

Information furnished in this document is believed to be accurate and reliable. However, Jiangsu JieJie Microelectronics Co., Ltd. assumes no responsibility for the consequences of use without consideration for such information nor use beyond it. Information mentioned in this document is subject to change without notice, apart from that when an agreement is signed, Jiangsu JieJie complies with the agreement. Products and information provided in this document have no infringement of patents. Jiangsu JieJie assumes no responsibility for any infringement of other rights of third parties which may result from the use of such products and information. This document supersedes and replaces all information previously supplied.

 is a registered trademark of Jiangsu JieJie Microelectronics Co., Ltd. Copyright © 2023 Jiangsu JieJie Microelectronics Co., Ltd. All rights reserved.