



DESCRIPTION:

JST02 series provide high dv/dt rate with strong resistance to electromagnetic interface.

They are especially recommended for use on home appliances such as motor control of washing machine, and for use on industrial control systems like electromagnetic valves. Package TO-252-4R is RoHS compliant. (2011/65/EU)

MAIN FEATURES

Symbol	Value	Unit
$I_{T(RMS)}$	2	A
I_{GT1-3}	10	mA
V_{DRM}/V_{RRM}	800/1000	V

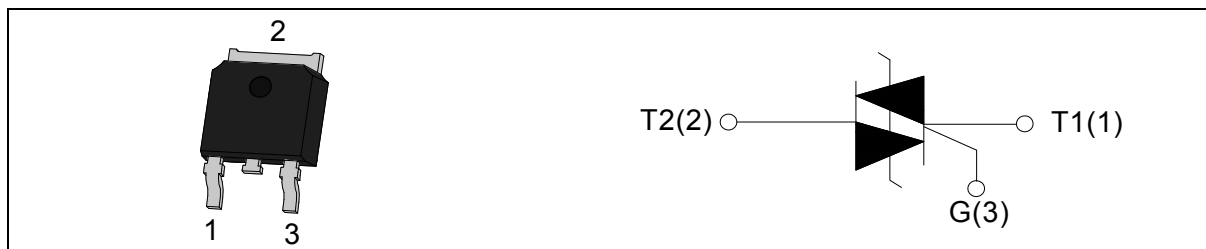

ABSOLUTE MAXIMUM RATINGS

Parameter	Symbol	Value	Unit
Storage junction temperature range	T_{stg}	-40-150	°C
Operating junction temperature range	T_j	-40-125	°C
Repetitive peak off-state voltage($T_j=25^{\circ}C$)	V_{DRM}	800/1000	V
Repetitive peak reverse voltage($T_j=25^{\circ}C$)	V_{RRM}	800/1000	V
RMS on-state current TO-252-4R ($T_C=100^{\circ}C$)	$I_{T(RMS)}$	2	A
Non repetitive surge peak on-state current (full cycle, F=50Hz)	I_{TSM}	20	A
I^2t value for fusing ($t_p=10ms$)	I^2t	2	A ² s
Rate of rise of on-state current ($I_G=2 \times I_{GT}$)	di/dt	50	A/ μ s
Peak gate current	I_{GM}	2	A
Average gate power dissipation	$P_{G(AV)}$	0.5	W
Peak gate power	P_{GM}	5	W

ELECTRICAL CHARACTERISTICS ($T_j=25^{\circ}\text{C}$ unless otherwise specified)

Symbol	Test Condition	Quadrant		Value	Unit
I_{GT}	$V_D=12\text{V } R_L=33\Omega$	I - II -III	MAX	10	mA
V_{GT}		I - II -III	MAX	1.3	V
V_{GD}	$V_D=V_{DRM} T_j=125^{\circ}\text{C}$ $R_L=3.3\text{K}\Omega$	I - II -III	MIN	0.2	V
I_L	$I_G=1.2I_{GT}$	I -III	MAX	20	mA
		II		40	
I_H	$I_T=100\text{mA}$		MAX	15	mA
dV/dt	$V_D=2/3V_{DRM}$ Gate Open $T_j=125^{\circ}\text{C}$		MIN	500	V/ μs

STATIC CHARACTERISTICS

Symbol	Parameter		Value(MAX)	Unit
V_{TM}	$I_{TM}=3.5\text{A } t_p=380\mu\text{s}$	$T_j=25^{\circ}\text{C}$	1.5	V
I_{DRM}	$V_D=V_{DRM} V_R=V_{RRM}$	$T_j=25^{\circ}\text{C}$	5	μA
I_{RRM}		$T_j=125^{\circ}\text{C}$	1	mA

THERMAL RESISTANCES

Symbol	Parameter		Value	Unit
$R_{th(j-c)}$	junction to case(AC)	TO-252-4R	6.5	$^{\circ}\text{C/W}$
$R_{th(j-a)}$	junction to ambient		70	

ORDERING INFORMATION

J	ST	02	K	-800	SW
JieJie Microelectronics Co.,Ltd					
Triacs					
$I_{T(RMS)}:2\text{A}$					
$I_{GT1-3} \leq 10\text{mA}$					
800: $V_{DRM} / V_{RRM} \geq 800\text{V}$					
1000: $V_{DRM} / V_{RRM} \geq 1000\text{V}$					
K: TO-252-4R					
KTR: TO-252-4R(Tape&Reel)					

PACKAGE MECHANICAL DATA

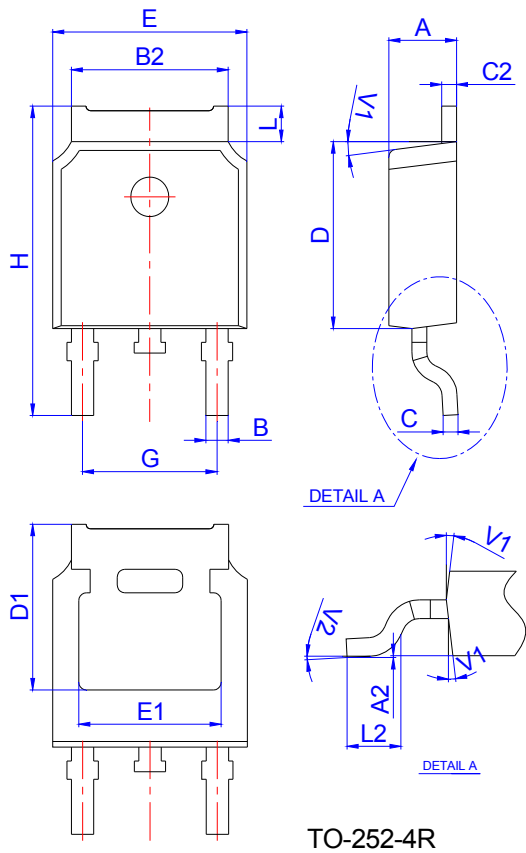

Ref.	Dimensions					
	Millimeters			Inches		
	Min.	Typ.	Max.	Min.	Typ.	Max.
A	2.10		2.50	0.083		0.098
A2	0		0.10	0		0.004
B	0.66		0.86	0.026		0.034
B2	5.18		5.48	0.202		0.216
C	0.40		0.60	0.016		0.024
C2	0.44		0.58	0.017		0.023
D	5.90		6.30	0.232		0.248
D1	5.30REF			0.209REF		
E	6.40		6.80	0.252		0.268
E1	4.63			0.182		
G	4.47		4.67	0.176		0.184
H	9.50		10.70	0.374		0.421
L	1.09		1.21	0.043		0.048
L2	1.35		1.65	0.053		0.065
V1		7°			7°	
V2	0°		6°	0°		6°

MARKING

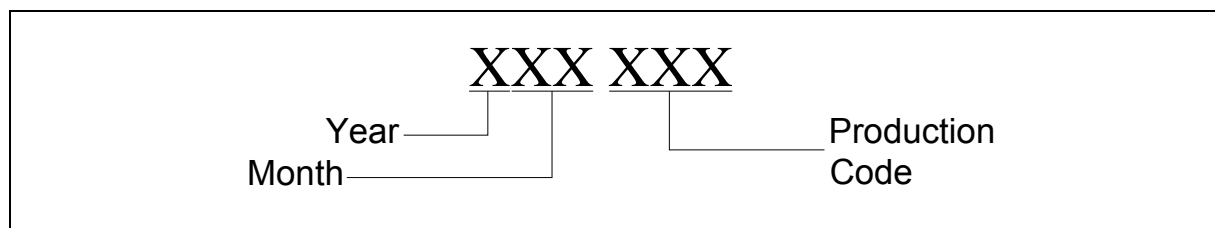
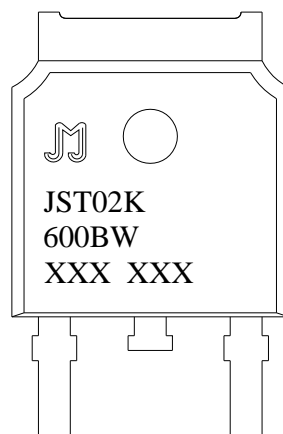

FOOTPRINT-TO-252-4R (dimensions in mm)

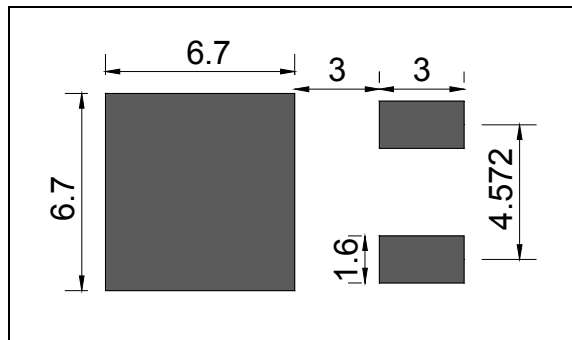

PACKAGE INFORMATION

PACKAGE	OUTLINE	REEL (PCS)	PER CARTON (PCS)	TAPE & REEL
TO-252-4R	TUBE	80	4,000	32,000
PACKAGE	OUTLINE	REEL (PCS)	PER CARTON (PCS)	TAPE & REEL
TO-252-4R	TAPING	2,500	25,000	13 inch

FIG.1: Maximum power dissipation versus RMS on-state current

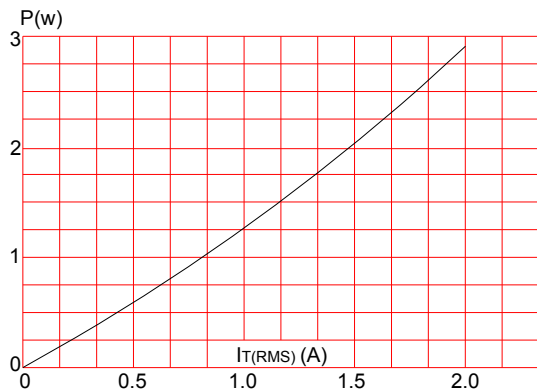

FIG.3: Surge peak on-state current versus number of cycles

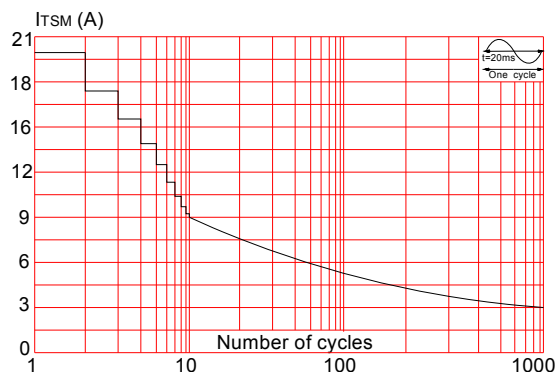

FIG.2: RMS on-state current versus ambient temperature (printed circuit board FR4, copper thickness:35μm)(full cycle)

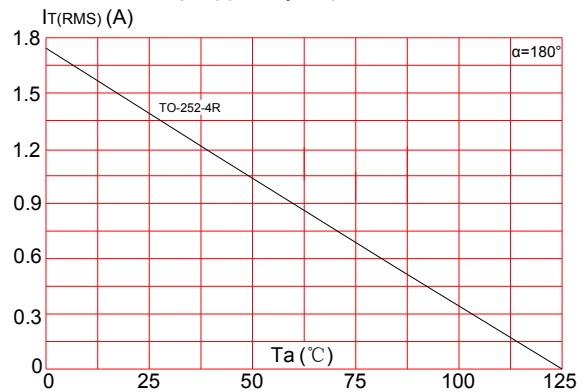

FIG.4: On-state characteristics (maximum values)

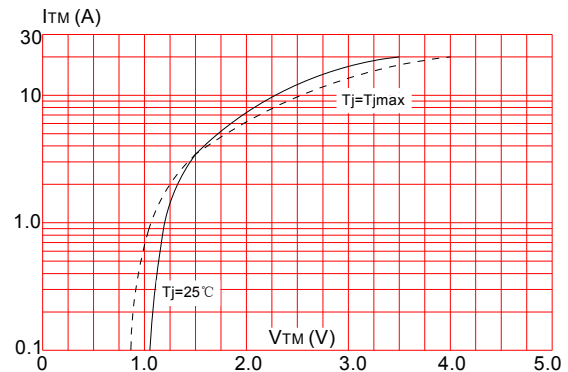

FIG.5: Relative variations of gate trigger current versus junction temperature

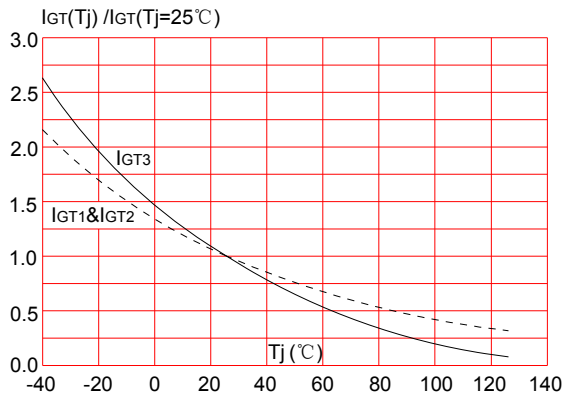
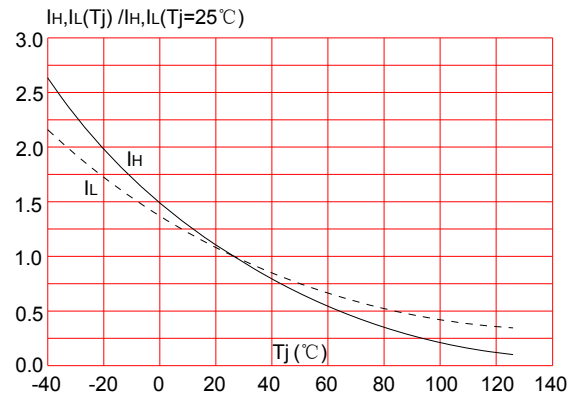
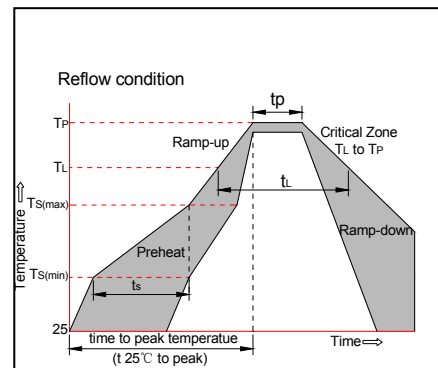

FIG.6: Relative variations of holding current, latching current versus junction temperature



SOLDERING PARAMETERS

Reflow Condition		Pb-Free assembly (see figure at right)
Pre Heat	-Temperature Min ($T_{s(min)}$)	+150°C
	-Temperature Max ($T_{s(max)}$)	+200°C
	-Time (Min to Max) (t_s)	60-180 secs.
Average ramp up rate (Liquidus Temp (T_L) to peak)		3°C/sec. Max
$T_{s(max)}$ to T_L - Ramp-up Rate		3°C/sec. Max
Reflow	-Temperature(T_L) (Liquidus)	+217°C
	-Temperature(t_L)	60-150 secs.
Peak Temp (T_p)		+260(+0/-5)°C
Time within 5°C of actual Peak Temp (t_p)		20-40secs.
Ramp-down Rate		6°C/sec. Max
Time 25°C to Peak Temp (T_p)		8 min. Max
Do not exceed		+260°C



Information furnished in this document is believed to be accurate and reliable. However, Jiangsu JieJie Microelectronics Co.,Ltd assumes no responsibility for the consequences of use without consideration for such information nor use beyond it. Information mentioned in this document is subject to change without notice, apart from that when an agreement is signed, Jiangsu JieJie complies with the agreement. Products and information provided in this document have no infringement of patents. Jiangsu JieJie assumes no responsibility for any infringement of other rights of third parties which may result from the use of such products and information. This document is the seventh version which is made in 16-Mar.-2019. This document supersedes and replaces all information previously supplied.

 is a registered trademark of Jiangsu JieJie Microelectronics Co.,Ltd.

Copyright©2019 Jiangsu JieJie Microelectronics Co.,Ltd. Printed All rights reserved.