



## JST04K-800SW 4A TRIACs

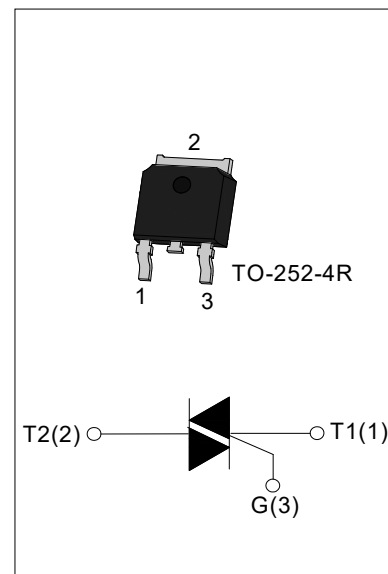
Rev.1

### DESCRIPTION:

With high ability to withstand the shock loading of large current, JST04K-800SW triacs provide high dv/dt rate with strong resistance to electromagnetic interface. With high commutation performances, especially recommended for use on inductive load. Package TO-252-4R is RoHS compliant. (2011/65/EU)

### MAIN FEATURES

Symbol	Value	Unit
$V_{DRM}/V_{RRM}$	800	V
$I_{T(RMS)}$	4	A



### ABSOLUTE MAXIMUM RATINGS

Parameter		Symbol	Value	Unit
Storage junction temperature range		$T_{stg}$	-40 - 150	°C
Operating junction temperature range		$T_j$	-40 - 125	°C
Repetitive peak off-state voltage ( $T_j=25^{\circ}C$ )		$V_{DRM}$	800	V
Repetitive peak reverse voltage ( $T_j=25^{\circ}C$ )		$V_{RRM}$	800	V
RMS on-state current	TO-252-4R ( $T_c=100^{\circ}C$ )	$I_{T(RMS)}$	4	A
Non repetitive surge peak on-state current (full cycle, F=50Hz)		$I_{TSM}$	40	A
$I^2t$ value for fusing ( $t_p=10ms$ )		$I^2t$	8	$A^2s$
Critical rate of rise of on-state current ( $I_G=2 \times I_{GT}$ )		$di/dt$	50	$A/\mu s$
Peak gate current		$I_{GM}$	4	A
Average gate power dissipation		$P_{G(AV)}$	1	W
Peak gate power		$P_{GM}$	5	W

ELECTRICAL CHARACTERISTICS ( $T_j=25^{\circ}\text{C}$  unless otherwise specified)

Symbol	Test Condition	Quadrant		Value	Unit
$I_{GT}$	$V_D=12\text{V } R_L=33\Omega$	I - II -III	MAX	10	mA
$V_{GT}$		I - II -III	MAX	1.5	V
$V_{GD}$	$V_D=V_{DRM} T_j=125^{\circ}\text{C}$ $R_L=3.3\text{K}\Omega$	I - II -III	MIN	0.2	V
$I_L$	$I_G=1.2I_{GT}$	I -III	MAX	20	mA
		II		35	
$I_H$	$I_T=100\text{mA}$		MAX	15	mA
dv/dt	$V_D=2/3V_{DRM}$ Gate Open $T_j=125^{\circ}\text{C}$		MIN	100	V/ $\mu\text{s}$

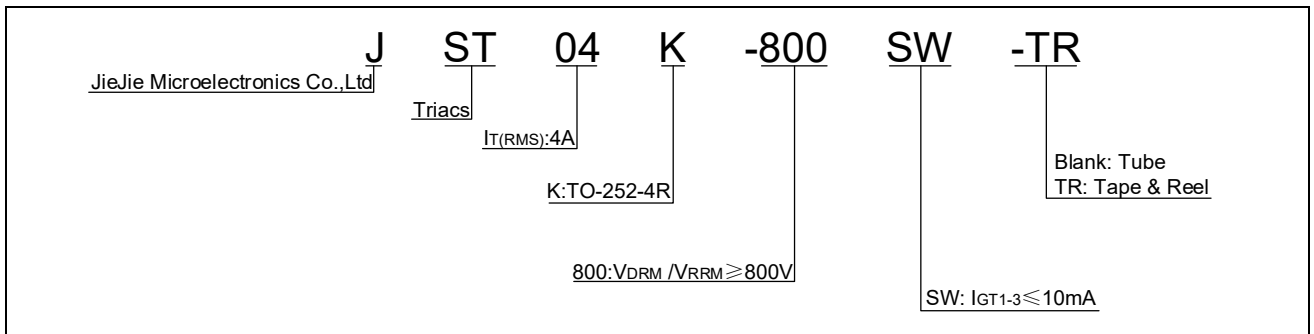
## STATIC CHARACTERISTICS

Symbol	Parameter		Value(MAX)	Unit
$V_{TM}$	$I_{TM}=5.5\text{A } t_p=380\mu\text{s}$	$T_j=25^{\circ}\text{C}$	1.5	V
$V_{TO}$	Threshold voltage	$T_j=125^{\circ}\text{C}$	0.93	V
$R_d$	Dynamic resistance	$T_j=125^{\circ}\text{C}$	97	m $\Omega$
$I_{DRM}$	$V_D=V_{DRM} V_R=V_{RRM}$	$T_j=25^{\circ}\text{C}$	10	$\mu\text{A}$
$I_{RRM}$		$T_j=125^{\circ}\text{C}$	0.75	mA

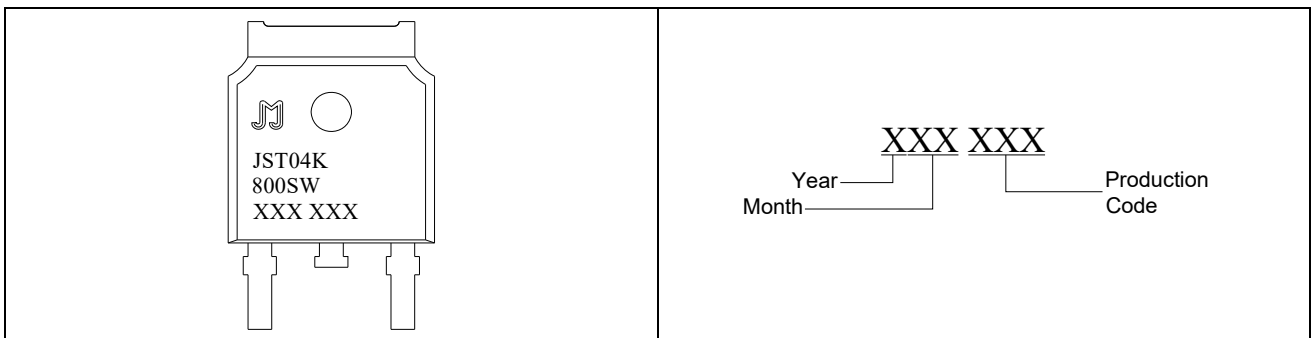
## THERMAL RESISTANCES

Symbol	Parameter		Value	Unit
$R_{th(j-c)}$	junction to case(AC)	TO-252-4R	2.8	$^{\circ}\text{C}/\text{W}$
$R_{th(j-a)}$	junction to ambient		70	

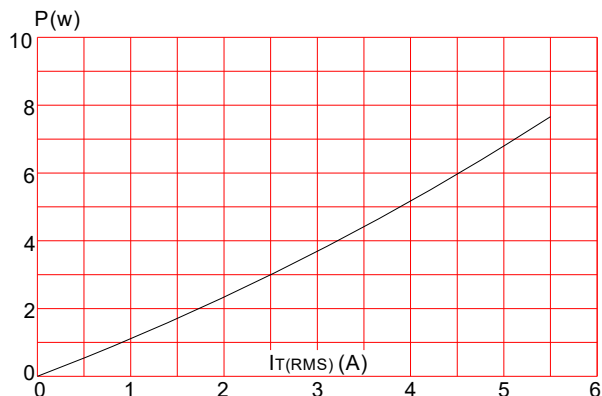
## ORDERING INFORMATION



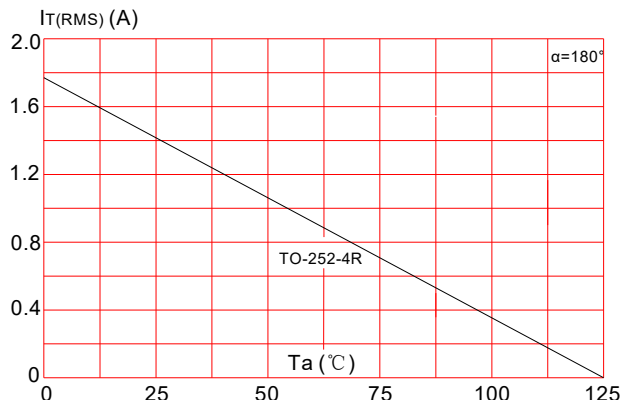
## MARKING



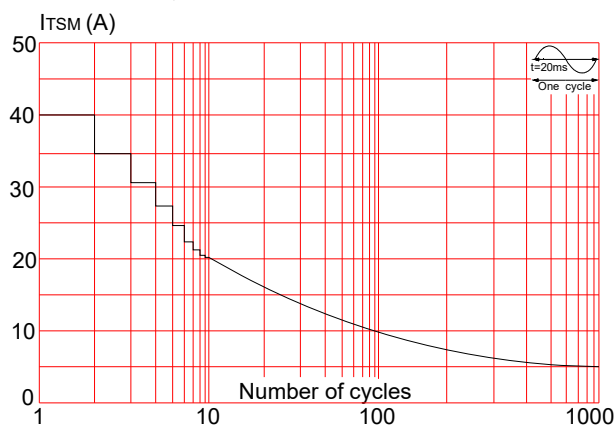
**FIG.1:** Maximum power dissipation versus RMS on-state current



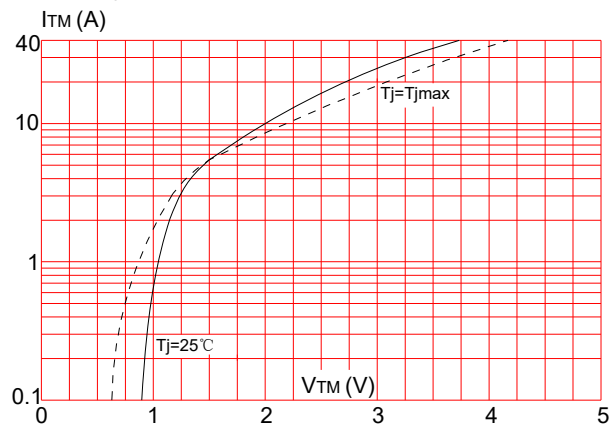
**FIG.2:** RMS on-state current versus ambient temperature (printed circuit board FR4, copper thickness:35μm)(full cycle)



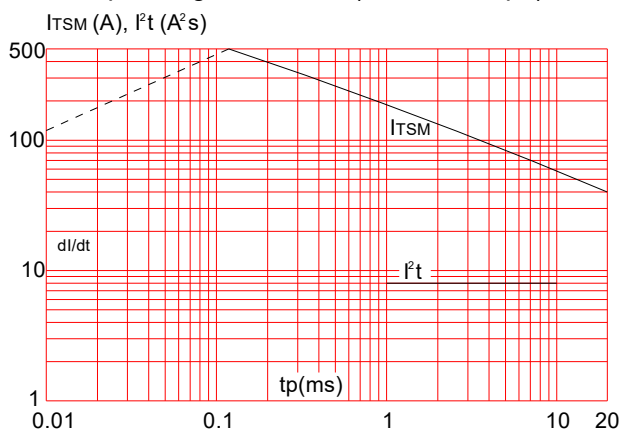
**FIG.3:** Surge peak on-state current versus number of cycles



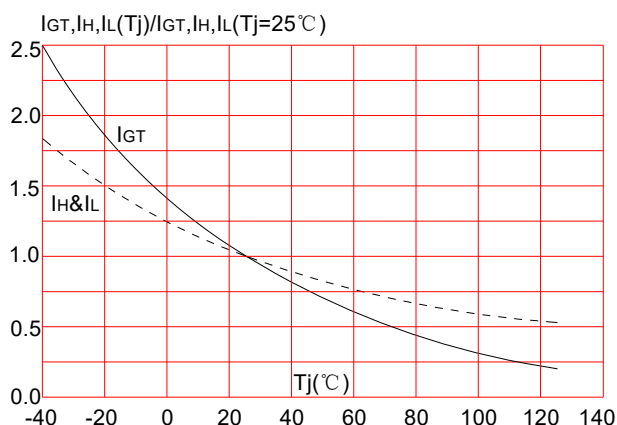
**FIG.4:** On-state characteristics (maximum values)



**FIG.5:** Non-repetitive surge peak on-state current for a sinusoidal pulse with width  $t_p < 20\text{ms}$  and corresponding value of  $I^2t$  ( $di/dt < 50\text{A}/\mu\text{s}$ )

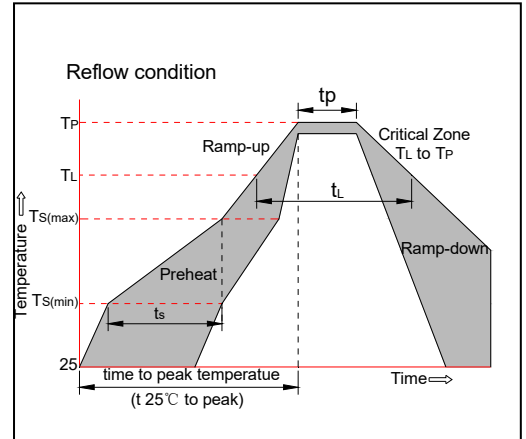


**FIG.6:** Relative variations of gate trigger current, holding current and latching current versus junction temperature



**SOLDERING PARAMETERS**

Reflow Condition		Pb-Free assembly (see figure at right)
Pre Heat	-Temperature Min ( $T_{s(min)}$ )	+150°C
	-Temperature Max ( $T_{s(max)}$ )	+200°C
	-Time (Min to Max) ( $t_s$ )	60-180 secs.
Average ramp up rate (Liquidus Temp ( $T_L$ ) to peak)		3°C/sec. Max
$T_{s(max)}$ to $T_L$ - Ramp-up Rate		3°C/sec. Max
Reflow	-Temperature( $T_L$ ) (Liquidus)	+217°C
	-Temperature( $t_L$ )	60-150 secs.
Peak Temp ( $T_p$ )		+260(+0/-5)°C
Time within 5°C of actual Peak Temp ( $t_p$ )		20-40secs.
Ramp-down Rate		6°C/sec. Max
Time 25°C to Peak Temp ( $T_P$ )		8 min. Max
Do not exceed		+260°C



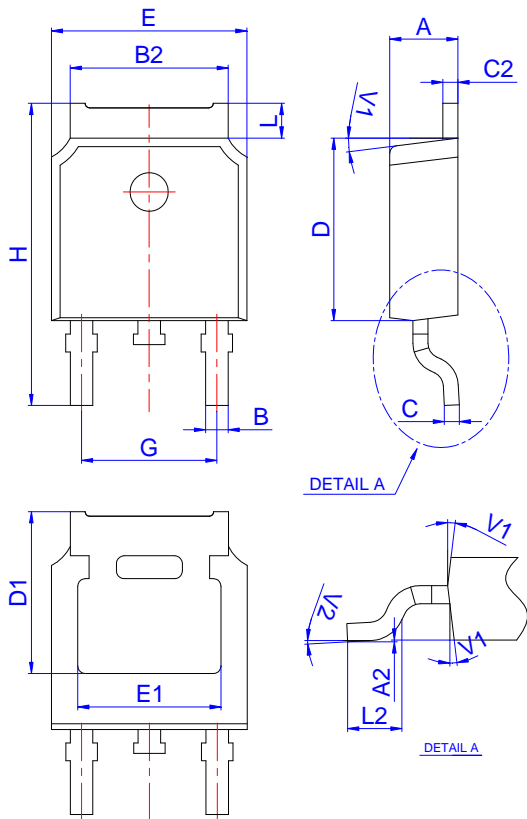
**ORDERING INFORMATION**

Order code	Voltage $V_{DRM}/V_{RRM}$ (V)	IGT(mA)	Package	Base qty. (pcs)	Delivery mode
JST04K-800SW	800	10	TO-252-4R	80	Tube
				2,500	Tape

**Document Revision History**

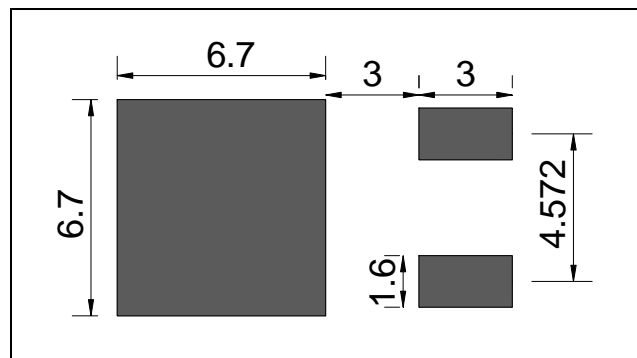
Date	Revision	Changes
Mar 27, 2022	1	Last update

PACKAGE MECHANICAL DATA

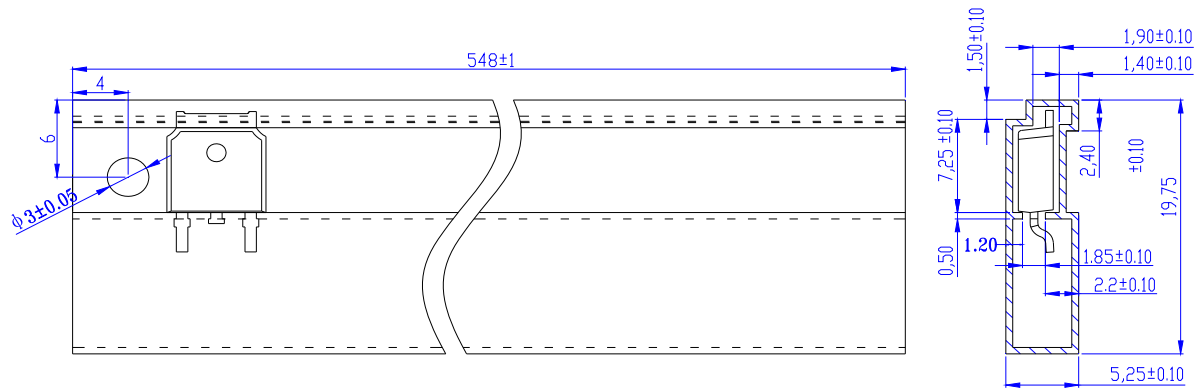


Ref.	Dimensions					
	Millimeters			Inches		
	Min.	Typ.	Max.	Min.	Typ.	Max.
A	2.10		2.50	0.083		0.098
A2	0		0.10	0		0.004
B	0.66		0.86	0.026		0.034
B2	5.18		5.48	0.202		0.216
C	0.40		0.60	0.016		0.024
C2	0.44		0.58	0.017		0.023
D	5.90		6.30	0.232		0.248
D1	5.30REF			0.209REF		
E	6.40		6.80	0.252		0.268
E1	4.63			0.182		
G	4.47		4.67	0.176		0.184
H	9.50		10.70	0.374		0.421
L	1.09		1.21	0.043		0.048
L2	1.35		1.65	0.053		0.065
V1		7°			7°	
V2	0°		6°	0°		6°

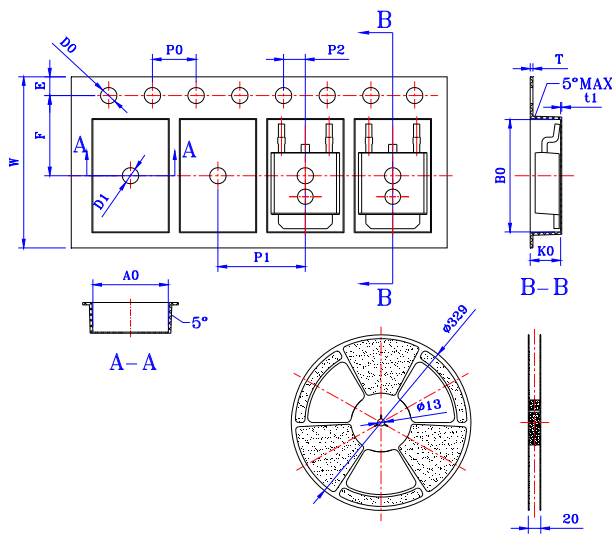
FOOTPRINT-TO-252-4R (dimensions in mm)



DELIVERY MODE



PACKAGE	OUTLINE	TUBE (PCS)	INNER BOX (PCS)	PER CARTON
TO-252-4R	TUBE	80	4,000	20,000



Ref.	Dimensions					
	Millimeters			Inches		
	Min.	Typ.	Max.	Min.	Typ.	Max.
W	15.90	16.00	16.10	0.626	0.630	0.634
E	1.65	1.75	1.85	0.065	0.069	0.073
F	7.40	7.50	7.60	0.291	0.295	0.299
D0	1.40	1.50	1.60	0.055	0.059	0.063
D1	1.40	1.50	1.60	0.055	0.059	0.063
P0	3.90	4.00	4.10	0.154	0.157	0.161
P1	7.90	8.00	8.10	0.311	0.315	0.319
P2	1.90	2.00	2.10	0.075	0.079	0.083
10P0	39.80	40.00	40.20	1.567	1.575	1.583
A0	6.85	6.90	7.00	0.270	0.272	0.276
B0	10.45	10.50	10.60	0.411	0.413	0.417
K0	2.68	2.78	2.88	0.106	0.109	0.113
T	0.24	-	0.27	0.009	-	0.011
ti	0.10	-	-	0.004	-	-

PACKAGE	OUTLINE	REEL (PCS)	PER CARTON (PCS)	TAPE & REEL
TO-252-4R	TAPING	2,500	25,000	13 inch





Information furnished in this document is believed to be accurate and reliable. However, Jiangsu JieJie Microelectronics Co.,Ltd assumes no responsibility for the consequences of use without consideration for such information nor use beyond it. Information mentioned in this document is subject to change without notice, apart from that when an agreement is signed, Jiangsu JieJie complies with the agreement. Products and information provided in this document have no infringement of patents. Jiangsu JieJie assumes no responsibility for any infringement of other rights of third parties which may result from the use of such products and information. This document supersedes and replaces all information previously supplied.

 is a registered trademark of Jiangsu JieJie Microelectronics Co.,Ltd.

Copyright ©2022 Jiangsu JieJie Microelectronics Co.,Ltd. Printed All rights reserved.