



JST12E-800SW 12A TRIACs

Rev.1

DESCRIPTION:

With high ability to withstand the shock loading of large current, JST12E-800SW triacs provide high dv/dt rate with strong resistance to electromagnetic interference. With high commutation performances, especially recommended for use on inductive load. Package TO-263 is RoHS compliant. (2011/65/EU)

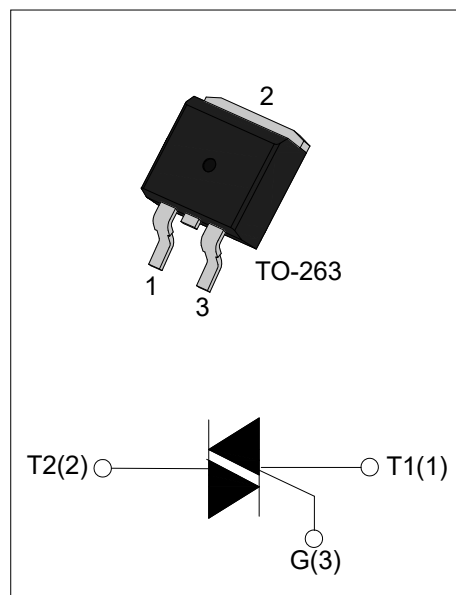

MAIN FEATURES

Symbol	Value	Unit
$I_{T(RMS)}$	12	A
V_{DRM}/V_{RRM}	800	V

ABSOLUTE MAXIMUM RATINGS

Parameter		Symbol	Value	Unit
Storage junction temperature range		T_{stg}	-40-150	°C
Operating junction temperature range		T_j	-40-125	°C
Repetitive peak off-state voltage ($T_j=25^\circ\text{C}$)		V_{DRM}	800	V
Repetitive peak reverse voltage ($T_j=25^\circ\text{C}$)		V_{RRM}	800	V
Non repetitive surge peak Off-state voltage		V_{DSM}	$V_{DRM} + 100$	V
Non repetitive peak reverse voltage		V_{RSM}	$V_{RRM} + 100$	V
RMS on-state current	TO-263 ($T_C=100^\circ\text{C}$)	$I_{T(RMS)}$	12	A
Non repetitive surge peak on-state current (full cycle, F=50Hz)		I_{TSM}	120	A
I^2t value for fusing ($t_p=10\text{ms}$)		I^2t	78	A^2s
Critical rate of rise of on-state current ($I_G=2 \times I_{GT}$)	I - II - III	di/dt	50	$\text{A}/\mu\text{s}$
Peak gate current		I_{GM}	4	A
Average gate power dissipation		$P_{G(AV)}$	1	W
Peak gate power		P_{GM}	5	W

ELECTRICAL CHARACTERISTICS ($T_j=25^{\circ}\text{C}$ unless otherwise specified)

Symbol	Test Condition	Quadrant		Value	Unit
I_{GT}	$V_D=12\text{V } R_L=33\Omega$	I - II -III	MAX	10	mA
V_{GT}		I - II -III	MAX	1.3	V
V_{GD}	$V_D=V_{DRM} T_j=125^{\circ}\text{C}$ $R_L=3.3\text{K}\Omega$	I - II -III	MIN	0.2	V
I_L	$I_G=1.2I_{GT}$	I -III	MAX	30	mA
		II		40	
I_H	$I_T=100\text{mA}$		MAX	20	mA
dv/dt	$V_D=2/3V_{DRM}$ Gate Open $T_j=125^{\circ}\text{C}$		MIN	200	V/ μs

STATIC CHARACTERISTICS

Symbol	Parameter		Value(MAX)	Unit
V_{TM}	$I_{TM}=17\text{A } t_p=380\mu\text{s}$	$T_j=25^{\circ}\text{C}$	1.5	V
I_{DRM}	$V_D=V_{DRM} V_R=V_{RRM}$	$T_j=25^{\circ}\text{C}$	5	μA
I_{RRM}		$T_j=125^{\circ}\text{C}$	1	mA

THERMAL RESISTANCES

Symbol	Parameter		Value	Unit
$R_{th(j-c)}$	junction to case(AC)	TO-263	1.4	$^{\circ}\text{C/W}$
$R_{th(j-a)}$	junction to ambient		45	

ORDERING INFORMATION

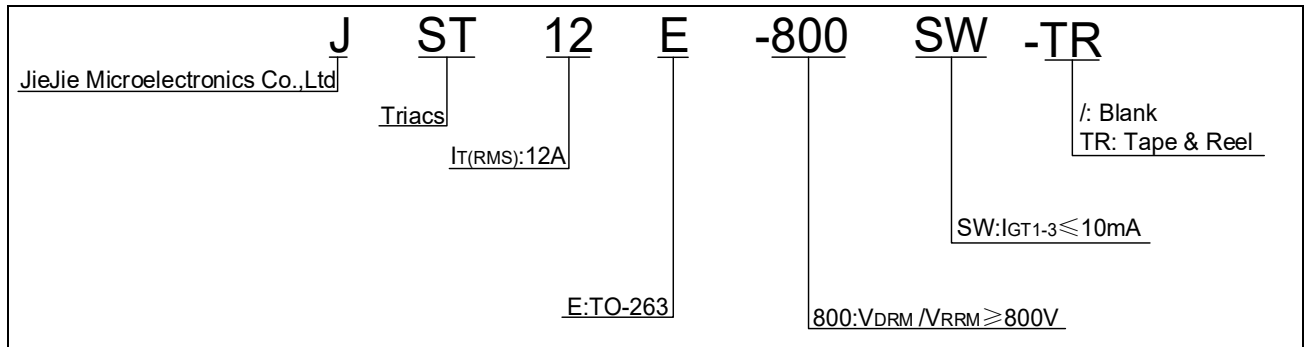

MARKING

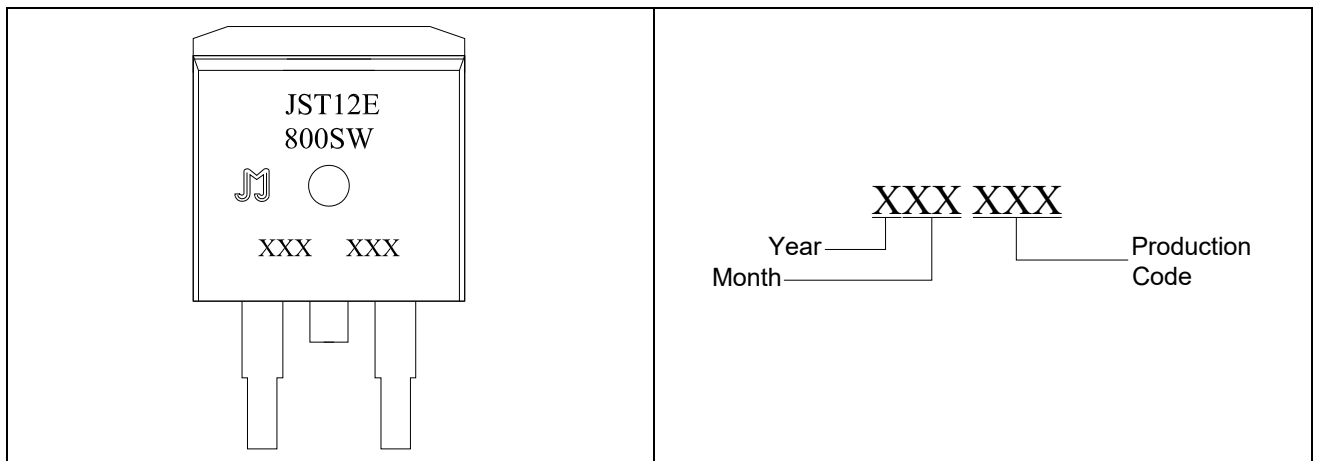

FIG.1 Maximum power dissipation versus RMS on-state current

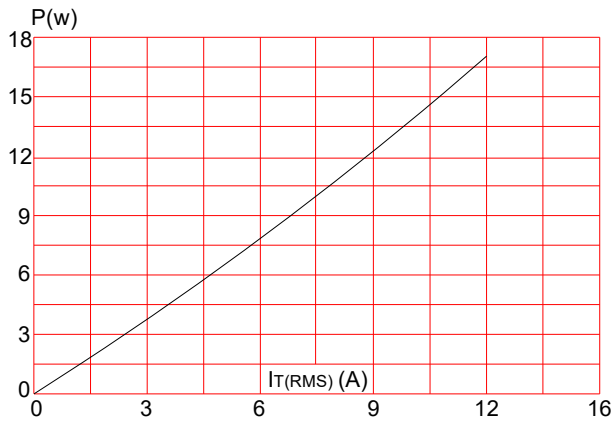

FIG.3: Surge peak on-state current versus number of cycles

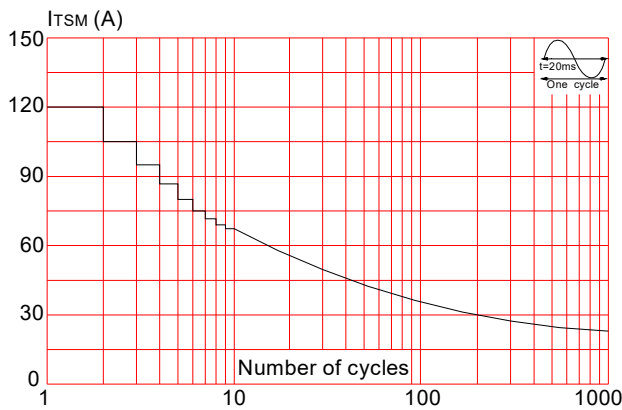

FIG.5: Non-repetitive surge peak on-state current for a sinusoidal pulse with width $t_p < 20\text{ms}$, and corresponding value of I^2t ($dI/dt(I-II-III) < 50\text{A}/\mu\text{s}$)

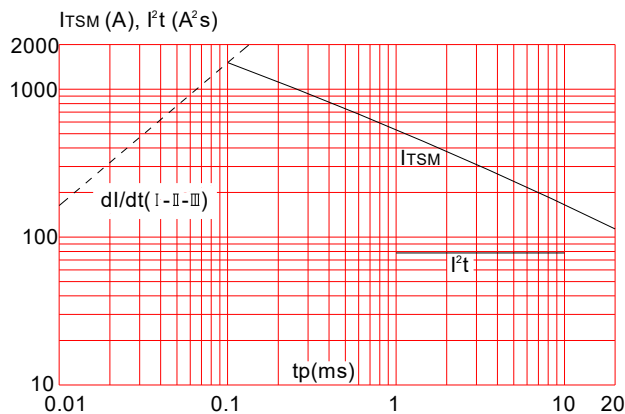

FIG.2: RMS on-state current versus ambient temperature (printed circuit board FR4, copper thickness: $35\mu\text{m}$) (full cycle)

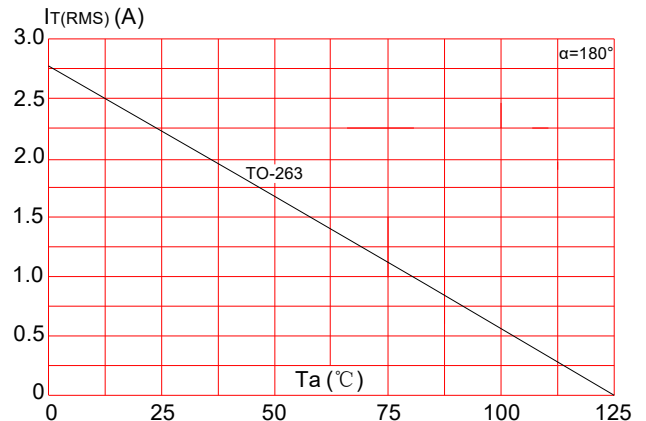

FIG.4: On-state characteristics (maximum values)

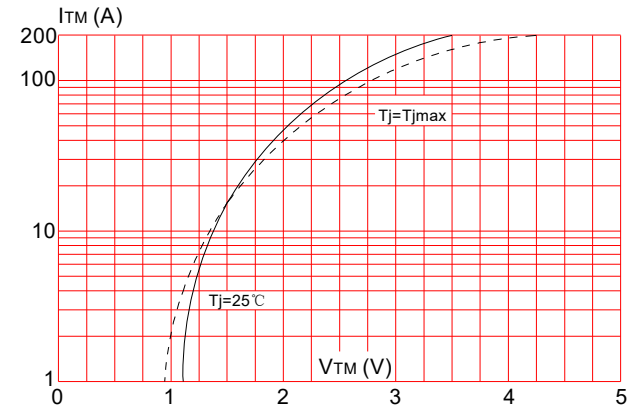
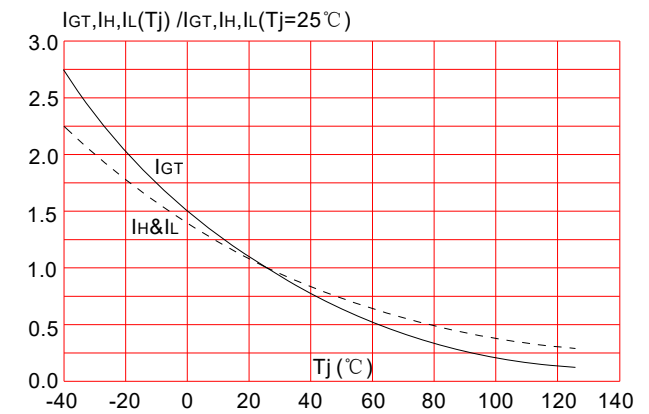
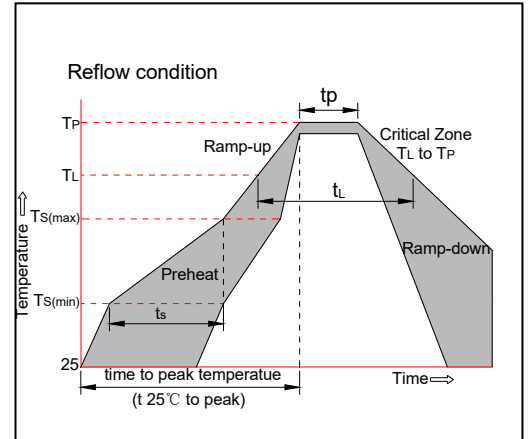

FIG.6: Relative variations of gate trigger current, holding current and latching current versus junction temperature



SOLDERING PARAMETERS

Reflow Condition		Pb-Free assembly (see figure at right)
Pre Heat	-Temperature Min ($T_{s(min)}$)	+150°C
	-Temperature Max($T_{s(max)}$)	+200°C
	-Time (Min to Max) (ts)	60-180 secs.
Average ramp up rate (Liquidus Temp (T_L) to peak)		3°C/sec. Max
$T_{s(max)}$ to T_L - Ramp-up Rate		3°C/sec. Max
Reflow	-Temperature(T_L) (Liquidus)	+217°C
	-Temperature(t_L)	60-150 secs.
Peak Temp (T_p)		+260(+0/-5)°C
Time within 5°C of actual Peak Temp (t_p)		20-40secs.
Ramp-down Rate		6°C/sec. Max
Time 25°C to Peak Temp (T_p)		8 min. Max
Do not exceed		+260°C



ORDERING INFORMATION

Order code	Voltage V_{DRM}/V_{RRM} (V)	IGT(mA)	Package	Base qty. (pcs)	Delivery mode
JST12E-800SW	800	10	TO-263	50	Tube
				800	Tape & Reel

Document Revision History

Date	Revision	Changes
Mar 16, 2022	1	Last updated

PACKAGE MECHANICAL DATA

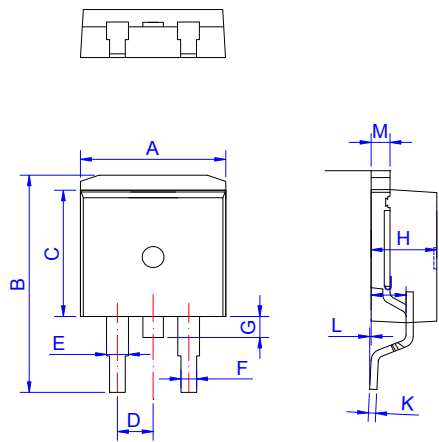

Ref.	Dimensions					
	Millimeters			Inches		
	Min.	Typ.	Max.	Min.	Typ.	Max.
A	9.90		10.20	0.390		0.402
B	14.70		15.80	0.579		0.622
C	9.4		9.6	0.37		0.378
D		2.54			0.100	
E	1.20		1.40	0.047		0.055
F	0.75		0.85	0.029		0.033
G			1.75			0.069
H	4.40		4.70	0.173		0.185
J	2.30		2.70	0.091		0.106
K	0.38		0.55	0.015		0.022
L	0	0.10	0.25	0	0.004	0.010
M	1.25		1.35	0.049		0.053

FOOTPRINT-TO-263 (dimensions in mm)

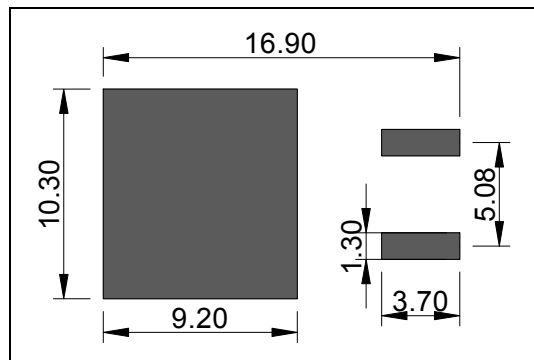

DELIVERY MODE

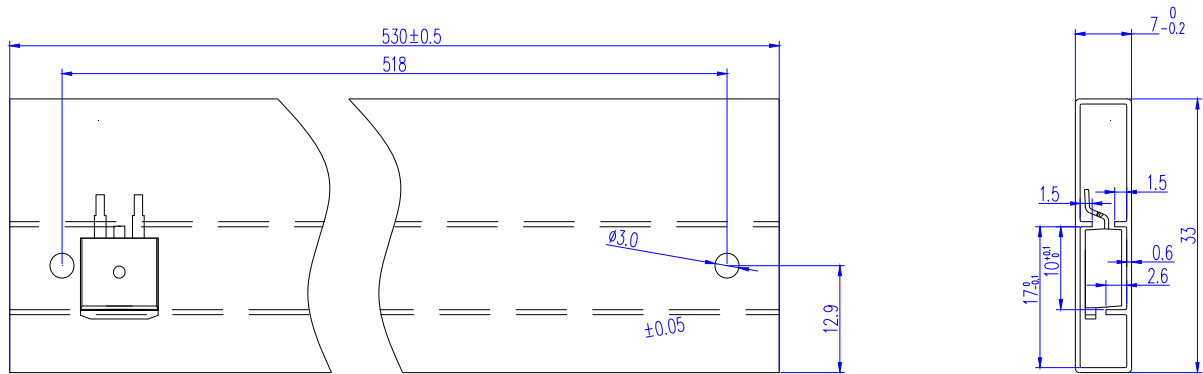

PACKAGE	OUTLINE	TUBE (PCS)	INNER BOX (PCS)	PER CARTON
TO-263	TUBE	50	1,000	5,000

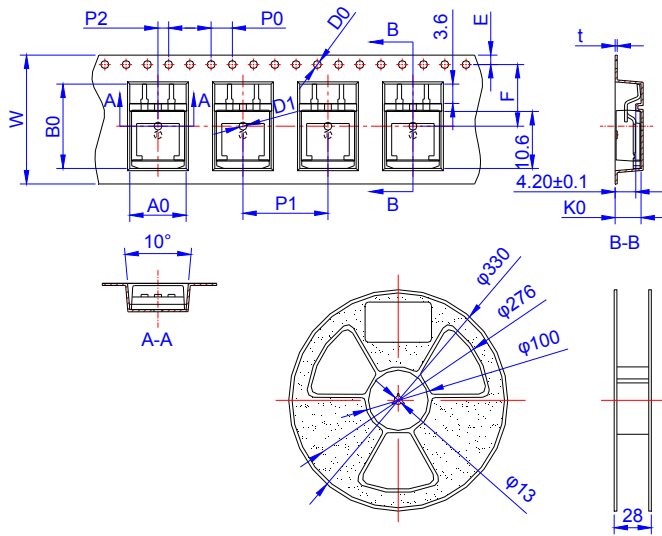

Ref.	Dimensions					
	Millimeters			Inches		
	Min.	Typ.	Max.	Min.	Typ.	Max.
W	23.70	24.00	24.30	0.933	0.945	0.957
E	1.65	1.75	1.85	0.065	0.069	0.073
F	11.40	11.50	11.60	0.449	0.453	0.457
D0	-	1.50	1.60	-	0.059	0.063
D1	-	1.50	1.60	-	0.059	0.063
P0	3.90	4.00	4.10	0.154	0.157	0.161
P1	15.90	16.00	16.10	0.626	0.630	0.634
P2	1.90	2.00	2.10	0.075	0.079	0.083
A0	10.80	10.90	11.00	0.425	0.429	0.433
B0	16.20	16.30	16.40	0.638	0.642	0.646
K0	4.80	4.90	5.00	0.189	0.193	0.197
t	0.35	0.40	0.45	0.014	0.016	0.018

PACKAGE	OUTLINE	REEL (PCS)	PER CARTON (PCS)	TAPE & REEL
TO-263	TAPING	800	4,000	13 inch



Information furnished in this document is believed to be accurate and reliable. However, Jiangsu JieJie Microelectronics Co.,Ltd assumes no responsibility for the consequences of use without consideration for such information nor use beyond it. Information mentioned in this document is subject to change without notice, apart from that when an agreement is signed, Jiangsu JieJie complies with the agreement. Products and information provided in this document have no infringement of patents. Jiangsu JieJie assumes no responsibility for any infringement of other rights of third parties which may result from the use of such products and information. This document supersedes and replaces all information previously supplied.



is a registered trademark of Jiangsu JieJie Microelectronics Co.,Ltd.
Copyright ©2022 Jiangsu JieJie Microelectronics Co.,Ltd. Printed All rights reserved.