

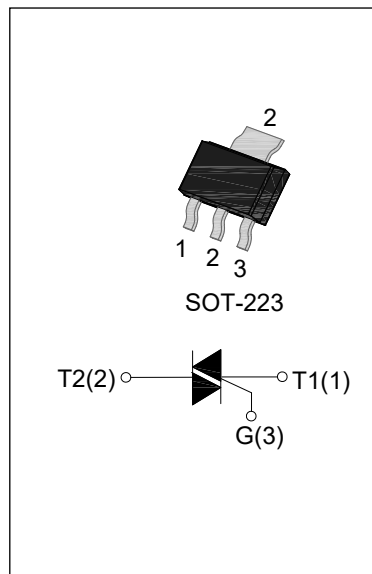

### DESCRIPTION:

With low holding and latching current, JST131V-800D series triacs are especially recommended for use on middle and small resistance type power load. Package SOT-223 listed above is RoHS compliant. (2011/65/EU)



### MAIN FEATURES

Symbol	Value	Unit
$I_{T(RMS)}$	1	A
$I_{TSM}$	16	A
$V_{TM}$	$\leq 1.5$	V

### ABSOLUTE MAXIMUM RATINGS

Parameter	Symbol	Value	Unit
Storage junction temperature range	$T_{stg}$	-40 - 150	$^{\circ}C$
Operating junction temperature range	$T_j$	-40 - 125	$^{\circ}C$
Repetitive peak off-state voltage ( $T_j=25^{\circ}C$ )	$V_{DRM}$	800	V
Repetitive peak reverse voltage ( $T_j=25^{\circ}C$ )	$V_{RRM}$	800	V
RMS on-state current SOT-223 ( $T_C=75^{\circ}C$ )	$I_{T(RMS)}$	1	A
Non repetitive surge peak on-state current (full cycle, F=50Hz)	$I_{TSM}$	16	A
$I^2t$ value for fusing ( $t_p=10ms$ )	$I^2t$	1.28	$A^2s$
Critical rate of rise of on-state current ( $I_G=2 \times I_{GT}$ )	$di/dt$	20	$A/\mu s$
Peak gate current	$I_{GM}$	2	A
Average gate power dissipation	$P_{G(AV)}$	0.5	W
Peak gate power	$P_{GM}$	5	W
Peak pulse voltage ( $T_j=25^{\circ}C$ ; non-repetitive, off-state; FIG.7)	$V_{PP}$	2.5	kV

**ELECTRICAL CHARACTERISTICS** ( $T_j=25^{\circ}\text{C}$  unless otherwise specified)

Symbol	Test Condition	Quadrant		Value	Unit
$I_{GT}$	$V_D=12\text{V } R_L=33\Omega$	I - II -III	MAX	5	mA
		IV		10	
$V_{GT}$		ALL	MAX	1.3	V
$V_{GD}$	$V_D=V_{DRM} T_j=125^{\circ}\text{C}$ $R_L=3.3\text{K}\Omega$	ALL	MIN	0.2	V
$I_L$	$I_G=1.2I_{GT}$	I -III-IV	MAX	5	mA
		II		20	
$I_H$	$I_T=200\text{mA}$		MAX	7	mA
dv/dt	$V_D=2/3V_{DRM}$ Gate Open $T_j=125^{\circ}\text{C}$		MIN	20	V/ $\mu\text{s}$
(dv/dt) <sub>c</sub>	(dl/dt) <sub>c</sub> =0.44A/ms, $T_j=110^{\circ}\text{C}$		MIN	1	V/ $\mu\text{s}$

**STATIC CHARACTERISTICS**

Symbol	Parameter		Value(MAX)	Unit
$V_{TM}$	$I_{TM}=1.4\text{A } t_p=380\mu\text{s}$	$T_j=25^{\circ}\text{C}$	1.5	V
$V_{TO}$	Threshold voltage	$T_j=125^{\circ}\text{C}$	0.95	V
$R_d$	Dynamic resistance	$T_j=125^{\circ}\text{C}$	256	m $\Omega$
$I_{DRM}$	$V_D=V_{DRM} V_R=V_{RRM}$	$T_j=25^{\circ}\text{C}$	5	$\mu\text{A}$
$I_{RRM}$		$T_j=125^{\circ}\text{C}$	0.5	mA

**THERMAL RESISTANCES**

Symbol	Parameter		Value	Unit
$R_{th(j-c)}$	junction to case(AC)	SOT-223	31	$^{\circ}\text{C}/\text{W}$
$R_{th(j-a)}$	junction to ambient	SOT-223	60	$^{\circ}\text{C}/\text{W}$

**ORDERING INFORMATION**

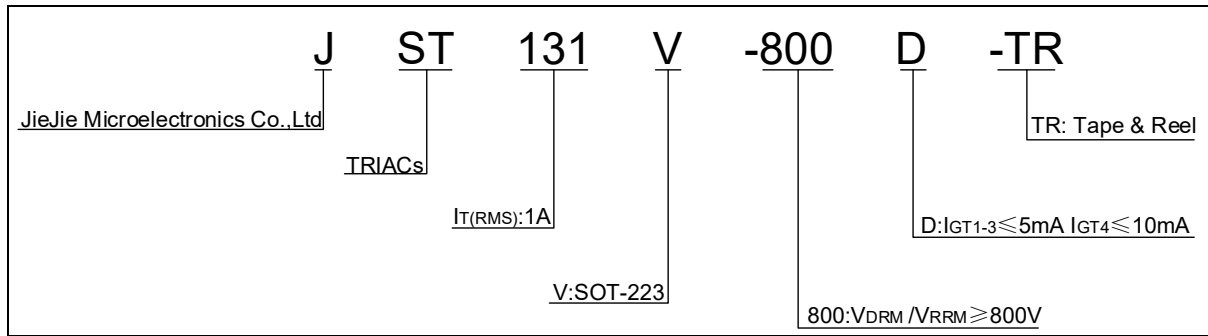

**MARKING**

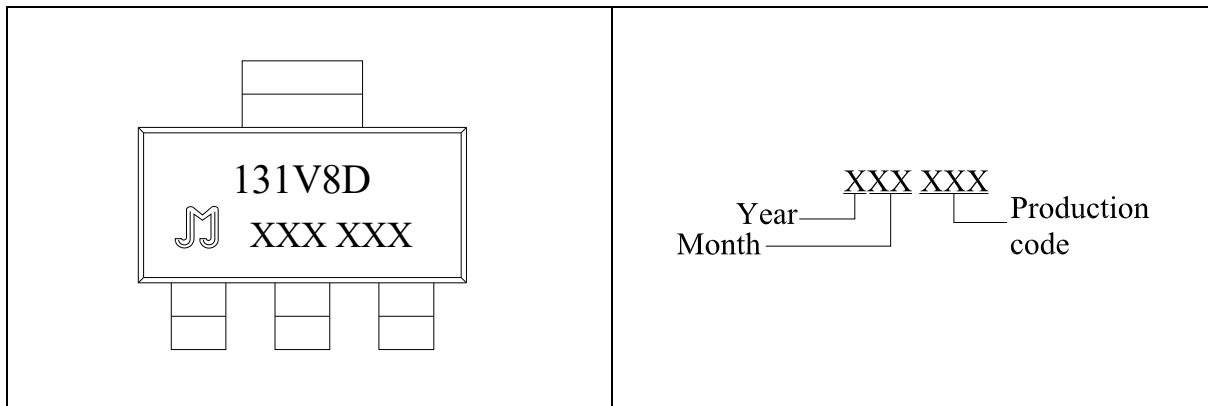

**FIG.1:** Maximum power dissipation versus RMS on-state current

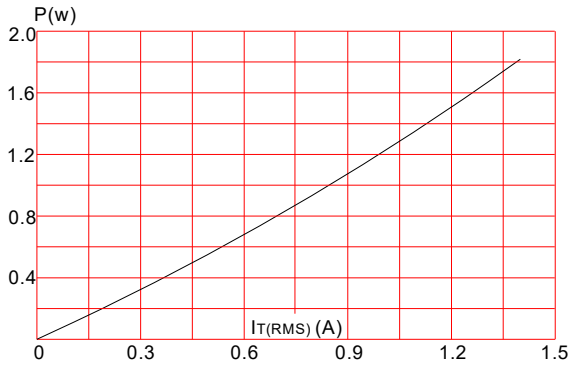

**FIG.2:** RMS on-state current versus ambient temperature (printed circuit board FR4, copper thickness: 35μm) (full cycle)

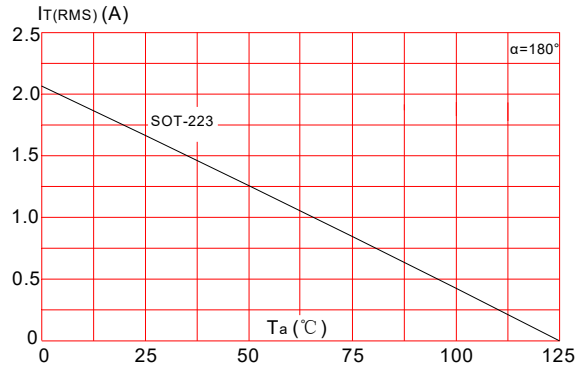

**FIG.3:** Surge peak on-state current versus number of cycles

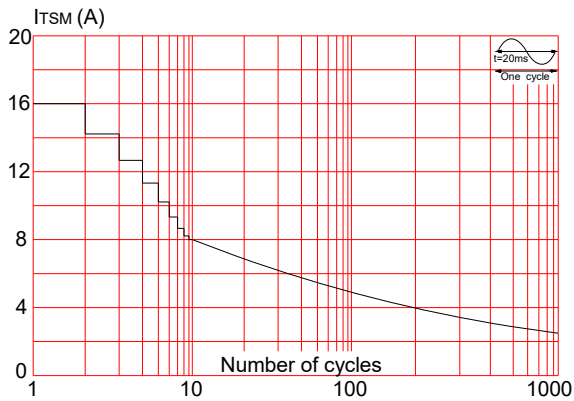

**FIG.4:** On-state characteristics (maximum values)

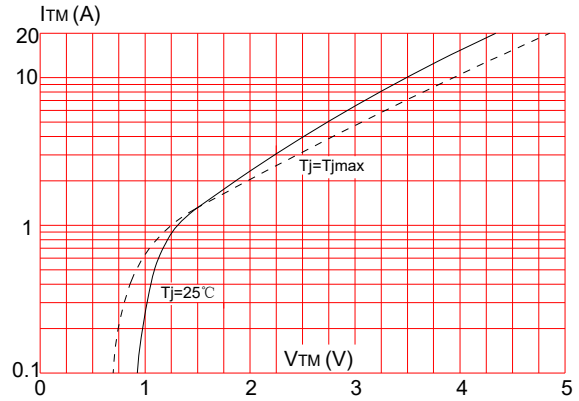

**FIG.5:** Non-repetitive surge peak on-state current for a sinusoidal pulse with width  $t_p < 20\text{ms}$  and corresponding value of  $I^2t$  ( $dI/dt < 20\text{A}/\mu\text{s}$ )

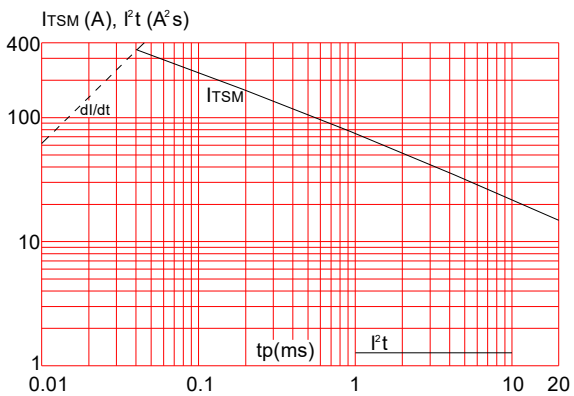

**FIG.6:** Relative variations of gate trigger current, holding current and latching current versus junction temperature

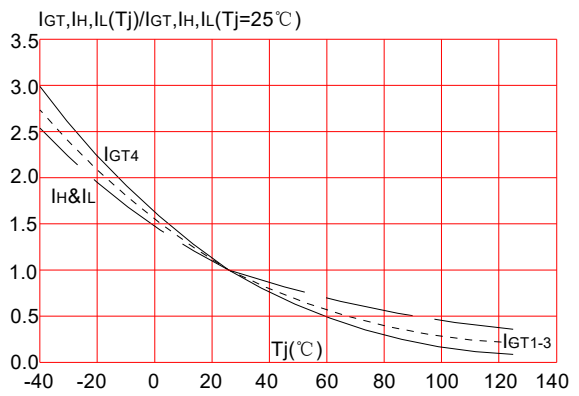
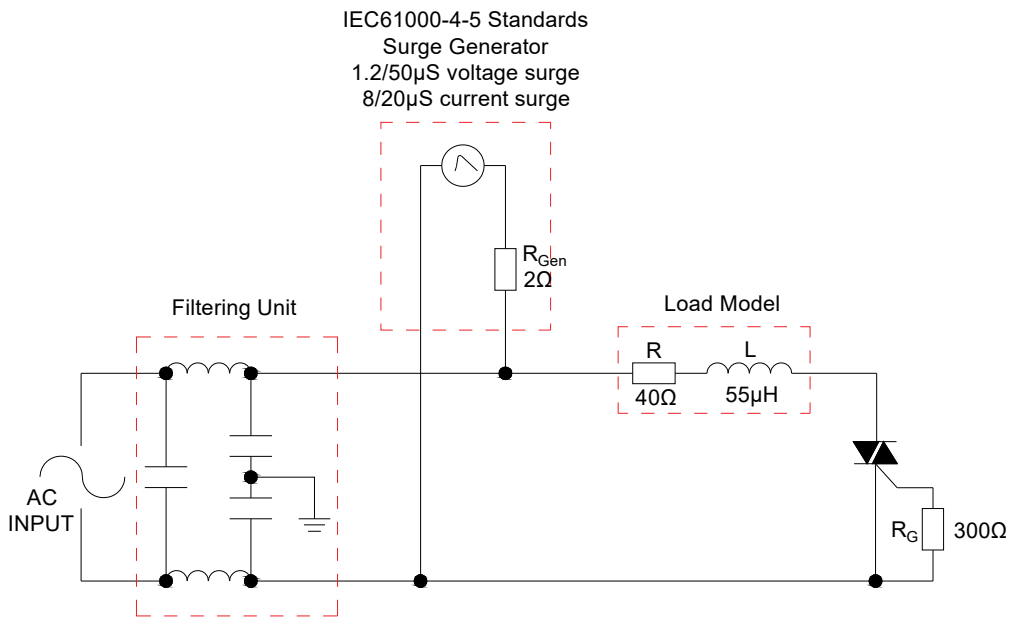
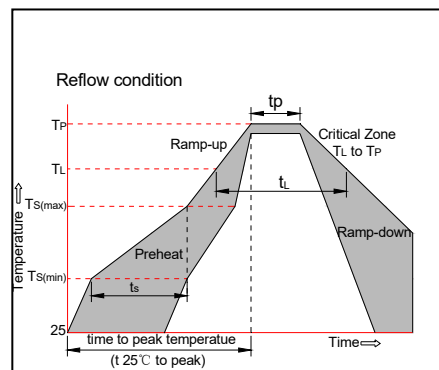

FIG.7: Test circuit for inductive and resistive loads to IEC-61000-4-5 standards.



**SOLDERING PARAMETERS**

Reflow Condition		Pb-Free assembly (see figure at right)
Pre Heat	-Temperature Min ( $T_{s(min)}$ )	+150°C
	-Temperature Max( $T_{s(max)}$ )	+200°C
	-Time (Min to Max) (ts)	60-180 secs.
Average ramp up rate (Liquidus Temp ( $T_L$ ) to peak)		3°C/sec. Max
$T_{s(max)}$ to $T_L$ - Ramp-up Rate		3°C/sec. Max
Reflow	-Temperature( $T_L$ ) (Liquidus)	+217°C
	-Temperature( $t_L$ )	60-150 secs.
Peak Temp ( $T_P$ )		+260(+0/-5)°C
Time within 5°C of actual Peak Temp ( $t_p$ )		20-40secs.
Ramp-down Rate		6°C/sec. Max
Time 25°C to Peak Temp ( $T_P$ )		8 min. Max
Do not exceed		+260°C



**ORDERING INFORMATION**

Order code	Voltage $V_{DRM}/V_{RRM}$ (V)	IGT(mA)		Package	Base qty. (pcs)	Delivery mode
		I -II-III	IV			
JST131V-800D	800	5	10	SOT-223	4,000	Tape & Reel

**Document Revision History**

Date	Revision	Changes
Mar 16, 2022	1	Last update

PACKAGE MECHANICAL DATA

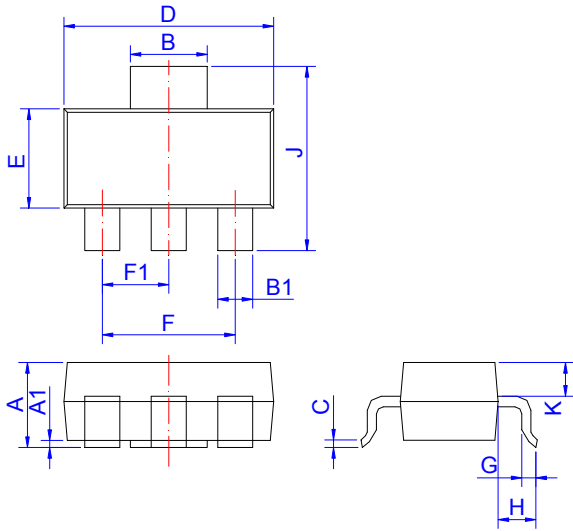

Ref.	Dimensions					
	Millimeters			Inches		
	Min.	Typ.	Max.	Min.	Typ.	Max.
A	1.5	1.6	1.8	0.059	0.063	0.071
A1	0.01	0.06	0.10	0.001	0.002	0.004
B	2.9	3.0	3.1	0.114	0.118	0.122
B1	0.6	0.7	0.8	0.024	0.028	0.031
C	0.22	0.26	0.32	0.009	0.010	0.013
D	6.3	6.5	6.7	0.248	0.256	0.264
E	3.3	3.5	3.7	0.130	0.138	0.146
F		4.6			0.181	
F1		2.3			0.091	
G	0.7	0.9	1.1	0.028	0.035	0.043
H	1.5	1.75	2.0	0.059	0.069	0.079
J	6.7	7.0	7.3	0.264	0.276	0.287
K	0.8	0.9	1.0	0.031	0.035	0.039

FOOTPRINT-SOT-223 (dimensions in mm)

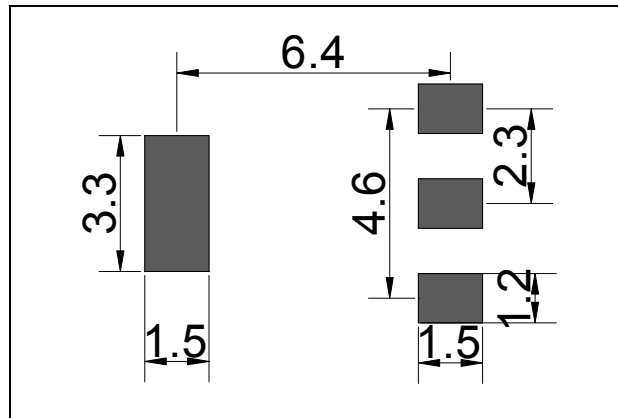

DELIVERY MODE

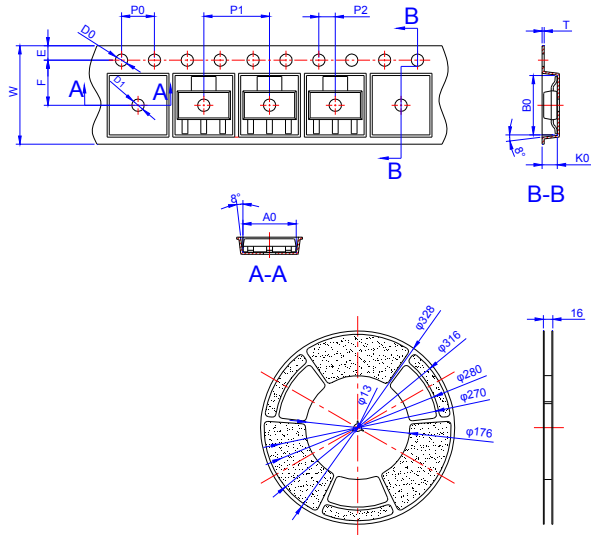

Ref.	Dimensions					
	Millimeters			Inches		
	Min.	Typ.	Max.	Min.	Typ.	Max.
W	-	12.00	12.20	-	0.472	0.480
E	1.65	1.75	1.85	0.065	0.069	0.073
F	5.45	5.50	5.55	0.215	0.217	0.219
D0	-	1.50	1.60	-	0.059	0.063
D1	-	1.55	1.80	-	0.061	0.071
P0	3.90	4.00	4.10	0.154	0.157	0.161
P1	7.90	8.00	8.10	0.311	0.315	0.319
P2	1.95	2.00	2.05	0.077	0.079	0.081
10P0	39.80	40.00	40.20	1.567	1.575	1.583
A0	6.73	6.83	6.93	0.265	0.269	0.273
B0	7.30	7.40	7.50	0.287	0.291	0.295
K0	1.78	1.88	1.98	0.070	0.074	0.078
T	0.25	0.30	0.35	0.010	0.012	0.014

PACKAGE	OUTLINE	REEL (PCS)	PER CARTON (PCS)	TAPE & REEL
SOT-223	TAPING	4,000	40,000	13 inch





Information furnished in this document is believed to be accurate and reliable. However, Jiangsu JieJie Microelectronics Co.,Ltd assumes no responsibility for the consequences of use without consideration for such information nor use beyond it. Information mentioned in this document is subject to change without notice, apart from that when an agreement is signed, Jiangsu JieJie complies with the agreement. Products and information provided in this document have no infringement of patents. Jiangsu JieJie assumes no responsibility for any infringement of other rights of third parties which may result from the use of such products and information. This document supersedes and replaces all information previously supplied.

 is a registered trademark of Jiangsu JieJie Microelectronics Co.,Ltd.

Copyright ©2022 Jiangsu JieJie Microelectronics Co.,Ltd. Printed All rights reserved.